

**Department of Spatial Sciences**

**Developing Collaborative Planning Support Tools  
for Optimised Farming In Western Australia**

**Deavi Purnomo**

**“This thesis is presented as part of the requirements for  
the award of the Degree of Doctor of Philosophy  
of the  
Curtin University of Technology”**

**July 2010**

## **Declaration**

To the best of my knowledge and belief this thesis contains no material previously published by any other person except where due acknowledgment has been made.

This thesis contains no material which has been accepted for the award of any other degree or diploma in any university.

Signature: .....

Date: .....

## ABSTRACT

Land-use (farm) planning is a highly complex and dynamic process. A land-use plan can be optimal at one point in time, but its currency can change quickly due to the dynamic nature of the variables driving the land-use decision-making process. These include external drivers such as weather and produce markets, that also interact with the biophysical interactions and management activities of crop production.

The active environment of an annual farm planning process can be envisioned as being cone-like. At the beginning of the sowing year, the number of options open to the manager is huge, although uncertainty is high due to the inability to foresee future weather and market conditions. As the production year reveals itself, the uncertainties around weather and markets become more certain, as does the impact of weather and management activities on future production levels. This restricts the number of alternative management options available to the farm manager. Moreover, every decision made, such as crop type sown in a paddock, will constrain the range of management activities possible in that paddock for the rest of the growing season.

This research has developed a prototype Land-use Decision Support System (LUDSS) to aid farm managers in their tactical farm management decision making. The prototype applies an innovative approach that mimics the way in which a farm manager and/or consultant would search for optimal solutions at a whole-farm level. This model captured the range of possible management activities available to the manager and the impact that both external (to the farm) and internal drivers have on crop production and the environment. It also captured the risk and uncertainty found in the decision space.

The developed prototype is based on a Multiple Objective Decision-making (MODM) - *à Posteriori* approach incorporating an *Exhaustive Search* method. The objective set used for the model is: maximising profit and minimising environmental impact. *Pareto* optimisation theory was chosen as the method to select the optimal solution and a *Monte Carlo* simulator is integrated into the prototype to incorporate the dynamic nature of the farm decision making process. The prototype has a user-

friendly front and back end to allow farmers to input data, drive the application and extract information easily.

## ACKNOWLEDGEMENTS

Thanks are due first and foremost to my supervisors, *Professor Murray McGregor* and *Professor Graciela Metternicht*. Both provided guidance, encouragement and patience in supervising my research work and the writing of this thesis. Their kind understanding and advice have been invaluable.

I would like to thank the ongoing support from the Collaborative Planning Support Tools for Optimising Farming systems (CPSTOF) project funded by a grant from the Australian Research Council, within the ARC-Linkage program (LP0219752), between Curtin University of Technology and The Department of Agriculture and Food Western Australia. A Curtin University Postgraduate Scholarship Award provided the majority of funding throughout the research.

Moreover, I would like to thank *Greg Beeston*, *Geoff Fosbery*, *James Fisher*, *Bill Bowden*, *Jim Altham* and *Amir Abadi* for our extensive discussions which helped me in building the *MOLup* (Multiple Objective Land-use planning) model.

Thanks are also extended to all current and former members of the Department of Spatial Sciences, who all together create such an inspiring and enjoyable working atmosphere. Gratitude is due to *Meredith Mulcahy* and *Lori Patterson* for their assistance in proof reading this thesis.

I would also like to acknowledge my colleagues at *Landgate* for all their support.

Special thanks and appreciation must go to my parents, *Nuridin* and *Vivien* for always being there for me, for without their indispensable life philosophy this thesis would not have been possible. I am also thankful for having my wonderful sisters, *Vivi* and *Sylvia*, who have been supportive all along.

Most of all I would like to thank my lovely husband, *Sten*. His love and precious guidance have been my source of inspiration and reassurance. Without his constant support this thesis would not have been completed.

Last but not least, special thanks are extended to my friends, *Dr. Lesley Arnold* and *Dr. Georgina Warren* for their constant encouragement and assistance in proof reading the final draft of this thesis.

## TABLE OF CONTENTS

ABSTRACT .....	i
ACKNOWLEDGEMENTS .....	iii
TABLE OF CONTENTS .....	v
TABLE OF FIGURES .....	xi
TABLE OF TABLES .....	xviii
TABLE OF PSEUDO CODE.....	xx
LIST OF ACRONYMS.....	xxi
CHAPTER 1	
INTRODUCTION.....	1
1.1 Problem Formulation.....	1
1.2 Background Information .....	2
1.2.1 Requirement of a micro level (agricultural) land-use planning system .....	2
1.2.2 Decision support system.....	3
1.2.3 Uncertainty and risk .....	4
1.2.4 Graphical user-friendly decision support tool .....	5
1.3 Research Objectives .....	5
1.4 Significance of the Thesis .....	6
1.5 Thesis Structure .....	8
CHAPTER 2	
LITERATURE REVIEW.....	10
2.1 Whole-Farm-Level Decision-Making Framework.....	10
2.1.1 The big picture: sustainable farming .....	12
2.1.2 Components of the farm management processes .....	15
2.1.2.1 Setting farm objectives and goals.....	15
2.1.2.2 Assessment .....	17
2.1.2.3 Planning, decision-making and implementation .....	18
2.1.2.4 Monitoring.....	20
2.2 Land-Use (Spatial) Decision Support System.....	20

2.3	The Spatial Element of LUDSS .....	21
2.4	Multi-Criteria Decision-Making (MCDM) .....	22
2.4.1	Pareto optimality .....	24
2.4.2	Multi-Criteria Decision-Making (MCDM) .....	26
2.5	Multiple Attribute Decision-Making (MADM) .....	27
2.5.1	No articulation of preference.....	28
2.5.2	Performance aggregation oriented methods .....	28
2.5.3	Preference aggregation-based.....	29
2.5.4	Interactive methods .....	30
2.5.5	Applications of MADM in natural resources management.....	30
2.6	Multiple Objective Decision-Making (MODM) .....	32
2.6.1	Multiple objectives function: preference articulation.....	32
2.6.1.1	No articulation of preference.....	33
2.6.1.2	<i>á Priori</i> articulation of preference .....	33
2.6.1.3	<i>Progressive</i> articulation of preferences .....	34
2.6.1.4	<i>á Posteriori</i> articulation of preferences .....	35
2.6.2	Optimisation methods.....	36
2.6.2.1	Direct optimisation technique: Mathematical Programming .....	36
2.6.2.2	Search techniques .....	38
2.6.2.2.1	Search methods.....	38
2.6.2.2.2	Ranking trade-off method .....	40
2.6.3	The relationship between optimisation methods and objective functions .....	40
2.6.4	Applications of MODM in natural resources management.....	41
2.7	Theories and Concepts for Dealing with Uncertainty .....	42
2.7.1	Incorporating uncertainty and accounting for risk .....	45
2.7.2	Expected utility based approach.....	45
2.7.3	Knowledge-based approach.....	46
2.7.4	Simulation approaches .....	46
2.7.5	Mathematical Programming .....	47
2.7.6	Applications of risk and uncertainty models in natural resource management.....	49



2.8	Assessing the Methods and Techniques Suitable to the Proposed LUDSS	51
2.8.1	Assessment multi-criteria functions and optimisation methods	51
2.8.2	Decision-making under uncertainty	56
2.9	Chapter Summary	58

## CHAPTER 3

### EVOLUTIONARY ALGORITHMS FOR MULTIPLE OBJECTIVE

OPTIMISATION	59	
3.1	Evolutionary Algorithms	59
3.2	Evolution: Adaptation and Speciation	60
3.3	Basic Elements of the Evolutionary Algorithm (EA)	64
3.3.1	Candidate representation	65
3.3.2	Intensification operators	66
3.3.2.1	Parent selection operator	67
3.3.2.2	Crossover operator	69
3.3.2.3	Child insertion (replacement) method	70
3.3.3	Diversification operators	70
3.4	Working on Multiple Objective Evolutionary Algorithm (MOEA)	71
3.4.1	Parameter settings	72
3.4.2	Multimodal surface	74
3.4.2.1	Niching	74
3.4.2.2	Restricted mating	75
3.4.2.3	Structured population and parallel Evolutionary Algorithm (EA)	76
3.4.3	Multiple objective functions (trade-offs)	78
3.5	Evolutionary Algorithm Search Prototype	79
3.5.1	Object representation	81
3.5.2	Fitness assignment and superior individual	83
3.5.3	Operator	84
3.5.3.1	Diversification operators: selection	84
3.5.3.2	Intensification operators: crossover and mutation	85
3.5.4	<i>TuGAs</i> model	85
3.5.4.1	Initialisation and evaluation phase	86

3.5.4.2	Assessment phase .....	86
3.5.4.3	Breeding .....	87
3.5.4.4	Parallel model.....	90
3.6	Model Assessment.....	90
3.7	Chapter Summary .....	92

## CHAPTER 4

METHODOLOGY .....	94	
4.1	Overview of the Research Approach.....	94
4.2	Initialise Parameters .....	97
4.3	The Input Phase - Creating the Database .....	99
4.3.1	Paddock land management.....	100
4.3.2	Land-use management assessment.....	101
4.3.3	Modelling uncertainty by using Monte Carlo .....	105
4.3.4	Crop production.....	109
4.3.4.1	Pre-processing crop production data .....	112
4.3.4.2	Adapting the crop production based on the year forecast .....	114
4.3.4.3	Predictions based on prior probabilities .....	117
4.3.4.3.1	Data driven approaches .....	117
4.3.4.3.2	Knowledge driven approaches .....	120
4.3.5	Commodity price.....	124
4.3.5.1	Spot cash price.....	124
4.3.5.1.1	Data driven approach.....	125
4.3.5.1.2	Hybrid data and knowledge driven approach .....	126
4.3.5.1.3	Advantages and disadvantages of each forecasting method .....	128
4.3.6	Environmental impact simulator .....	128
4.4	Search and Optimise Phase .....	132
4.4.1	Search and optimise methods .....	134
4.4.1.1	Exhaustive Search .....	134
4.4.1.2	Integrating a heuristic technique .....	136
4.4.2	Whole-farm land-use plan assessment .....	139

4.4.3	Pareto optimal.....	143
4.5	Output Phase.....	146
4.5.1	Output portraying all <i>WLuM</i> options (populations of chromosomes) .....	148
4.5.2	Output portraying a selected <i>WLuM</i> option (a chromosome) .....	153
4.5.2.1	Histograms.....	153
4.5.2.2	Spread tables.....	154
4.5.3	Output portraying the paddock land-use management setting of the selected <i>WLuM</i> option (alleles of the chromosomes).....	155
4.5.4	Cartographic output.....	156
4.6	Software Design, Databases and User Interface .....	157
4.6.1	Databases.....	157
4.6.2	Libraries.....	158
4.6.3	<i>MOLup</i> user interfaces and facilities.....	159
4.6.3.1	First mode: creating a new farm planning scenario.....	162
4.6.3.2	Second mode: connecting an existing farm planning scenario.....	162
4.6.3.3	Third mode: opening <i>MOLup</i> farm planning scenario's old results.....	168
4.7	Chapter Summary.....	168
 CHAPTER 5		
CASE STUDY .....		169
5.1	Northam and Beverley.....	169
5.2	Northam Weather - Rainfall Data.....	170
5.3	Crops production and Environmental Impact .....	179
5.3.1	Paddock and land management units .....	179
5.3.2	Crop type .....	184
5.3.3	Fertiliser and chemical spray.....	185
5.4	Market .....	185
5.5	<i>MOLup</i> as the Tool.....	188
5.5.1	Results obtained for the January run .....	189
5.5.2	Results obtained for the processes performed in March - planning stage.....	196

5.5.3	Results obtained for the processes performed from April to July - during the sowing window .....	204
5.5.4	Post sowing window (July to September) .....	219
5.6	Chapter Summary .....	223
 CHAPTER 6		
CONCLUSIONS AND RECOMMENDATIONS.....		226
6.1	Problem Description and Research Objectives .....	227
6.2	Research Outcomes .....	228
6.2.1	Capturing the decision-making environment .....	228
6.2.2	Developing a LUDSS model.....	230
6.2.3	Analysis and modelling of risk and uncertainty.....	231
6.2.4	Building a user interface.....	232
6.3	<i>MOLup</i> as a Tool.....	233
6.4	Recommendation for Future Work.....	234
6.4.1	Input data improvement.....	234
6.4.2	Model enhancement .....	235
6.4.3	Hardware requirement.....	238
REFERENCES.....		239

## TABLE OF FIGURES

Figure 1.1 Flow diagram of thesis chapters.....	8
Figure 2.1 Whole-farm management.....	10
Figure 2.2 The components of whole-farm planning; Source: Australian Banker's Association Inc. (2004) .....	11
Figure 2.3 Foot print of the changes that happen during the year .....	14
Figure 2.4 Influences on goal setting; Source: Joerger (1999).....	16
Figure 2.5 Planning at the beginning of the year .....	18
Figure 2.6 Schematic representation of the planning period.....	19
Figure 2.7 Integration approaches of spatial information .....	21
Figure 2.8 GIS integration approaches; Source: Lilburne (1996) .....	21
Figure 2.9 Solution search space and objective space for a multiple (2D) objective problem.....	23
Figure 2.10 Trade-off solutions (Matthews 2001) .....	24
Figure 2.11 An objective space solution of two objectives .....	25
Figure 2.12 LUDSS: Analysing MCDM methods .....	26
Figure 2.13 General procedure of the two MCDM methods (Chakhar and Martel 2003).....	27
Figure 2.14 MADM methods .....	28
Figure 2.15 Procedure for problem resolution using a MODM method .....	32
Figure 2.16 MODM methods classification (Hwang <i>et al.</i> 1980).....	33
Figure 2.17 Techniques to optimise multiple objective problems .....	36
Figure 2.18 Relationship between MODM objective functions type and optimisation methods .....	37
Figure 2.19 Risk and uncertainty modelling approaches and methods .....	45
Figure 2.20 MODM problem .....	52
Figure 2.21 Selection of the <i>á Posteriori</i> articulate method.....	53
Figure 2.22 Selection of the method of assessment: <i>á Posteriori</i> articulation, with two different search techniques: Exhaustive Search or Genetic Algorithm .....	55
Figure 2.23 Selection of the <i>á Posteriori</i> articulation: <i>Pareto</i> Optimisation method for the selection stage .....	56

Figure 2.24 Incorporating the uncertainty element to account for risk .....	57
Figure 3.1 MCDM: Genetic Algorithm and <i>Pareto</i> dominance .....	59
Figure 3.2 The process of <i>Natural Selection</i> (University of Michigan 2005).....	61
Figure 3.3 Chromosomes; Source: Access Excellence The National Health Museum (1999) .....	63
Figure 3.4 Chinese box representation of DNA, Gene, Chromosome and Genome; Source: Genome News Network (2003).....	63
Figure 3.5 Basic structure of GA (Eiben and Smith 2003) .....	64
Figure 3.6 Elements and components of EA .....	64
Figure 3.7 EA candidate representation .....	65
Figure 3.8 Decisive spaces (two decision variables $x$ ) and the corresponding objective space (two objective variables).....	66
Figure 3.9 The Roulette Wheel .....	67
Figure 3.10 The <i>Crossover</i> process .....	69
Figure 3.11 The <i>Mutation</i> process.....	71
Figure 3.12 Possible trapped solution .....	72
Figure 3.13 Tools employed for comparing chromosomes.....	75
Figure 3.14 PEA population approaches (Alba and Tomassini 2002).....	77
Figure 3.15 Schematic representation of the whole-farm management options based on the EA concept .....	81
Figure 3.16 Hybrid chromosome representation of <i>TuGAs</i> .....	82
Figure 3.17 Population with <i>superior list</i> .....	83
Figure 3.18 Tournament selection process.....	84
Figure 3.19 General structure of the overall <i>TuGAs</i> system .....	86
Figure 3.20 Assessment phase processes .....	87
Figure 3.21 Crossover between two parents A1 and A2 to produce two offsprings B1 and B2. The population in the generation B will become parents and produce the next generation offspring C1 and C2.....	88
Figure 3.22 Reproduction phase processes .....	89
Figure 3.23 Five islands with a set of population in every island .....	90
Figure 3.24 Multiple Objective solution space for a problem discovered by using two different models (Bladt 2002) .....	91
Figure 4.1 <i>MOLup</i> stages .....	95
Figure 4.2 Trade-off: profit and environmental impact.....	95

Figure 4.3 Each gene within a chromosome has a set selection of alleles .....	96
Figure 4.4 Decision space and objective space for genes; A variable $x$ represents one land-use management element (i.e. only two elements are shown) .....	97
Figure 4.5 <i>Gross income, gross margin</i> (unit and enterprise), and <i>profit</i> .....	97
Figure 4.6 Setting <i>MOLup</i> Parameters .....	98
Figure 4.7 Marketing decisions .....	99
Figure 4.8 Input phase processes.....	100
Figure 4.9 Data flow in input phase .....	100
Figure 4.10 Different land-use management options (i.e. allele) for a paddock (i.e. gene) .....	101
Figure 4.11 Gross margin from a land-use management on a paddock .....	102
Figure 4.12 An example of climate forecasting and crop production estimation ....	102
Figure 4.13 A sample result of Monte Carlo process based on the spot market trading (see Section 4.3.3 for Monte Carlo procedure) .....	103
Figure 4.14 Sample of crop production of a paddock based on a specified land-use management option .....	103
Figure 4.15 Determining the most probable crop product .....	104
Figure 4.16 Sample of selecting crop products using threshold $p$ -value.....	104
Figure 4.17 Monte Carlo simulation of the physical system weather .....	105
Figure 4.18 Monte Carlo simulation of a mathematical model $G$ (see Pseudo-code 4.1).....	106
Figure 4.19 APSIM and WA Wheat .....	109
Figure 4.20 APSIM simulation framework, a central interface engine that connects individual crop and soil modules (Keating <i>et al.</i> 2003) .....	110
Figure 4.21 A sample of WA Wheat results based on one set of land-use management options.....	112
Figure 4.22 Sample crop production distribution of a land-use management option based on season type (see Table 4.3 for classification).....	114
Figure 4.23 Crop production amassing based on the probability of season type.....	116
Figure 4.24 Methods to obtain crop production distribution based on season types	117
Figure 4.25 Crop production based on season type probability .....	118
Figure 4.26 Venn diagram of Beverley weather data.....	119
Figure 4.27 Categorisation of crop production distribution (based on season type) into classes of crop production, based on $P$ possibility classes. The	

<i>normalised chance C</i> is then evaluated and used to aggregate crop production.....	122
Figure 4.28 Additive <i>chance (C)</i> value (see Pseudo-code 4.5) .....	123
Figure 4.29 Work example on estimating spot cash price distribution (of ASWN) by using a simple probability value for each season type (see Psuedo-code 4.6).....	126
Figure 4.30 Spot price distribution.....	126
Figure 4.31 Example of estimating spot cash price distribution by using the current spot price and (subjective) variability/standard deviation.....	128
Figure 4.32 Environmental impact simulator processes.....	129
Figure 4.33 Environmental impact results based on one <i>LuM</i> option.....	131
Figure 4.34 The input and output of the search and optimise phase .....	133
Figure 4.35 A sample of whole-farm land-use plan with chromosome fitness values (i.e. profit and environmental impact).....	133
Figure 4.36 Search and optimise by using Exhaustive Search approach .....	134
Figure 4.37 Explosive combination of whole-farm land-use plan options .....	135
Figure 4.38 Search (employing <i>pre-selection</i> method) and optimise.....	136
Figure 4.39 Cutting the chase (see Figure 4.40 for procedure).....	137
Figure 4.40 <i>Pre-selection</i> process .....	137
Figure 4.41 Sample of aggregating the whole-farm results .....	140
Figure 4.42 Processes for obtaining whole-farm proceeds .....	141
Figure 4.43 Pyramidising processes, excluding definite “inferior” points prior to the <i>Pareto Optimisation</i> process .....	143
Figure 4.44 Creating “Cells” of a <i>Pareto</i> plot.....	144
Figure 4.45 Example of <i>Pareto</i> filtering .....	145
Figure 4.46 Setting <i>Pareto Optimal</i> processes (see Pseudo-code 4.11).....	145
Figure 4.47 A sample of <i>MOLup</i> overall output presentation.....	147
Figure 4.48 Summary of the <i>MOLup</i> output .....	148
Figure 4.49 Example of a scatter plot.....	149
Figure 4.50 <i>MOLup</i> scatter plot (see Figure 4.51 for an example) .....	150
Figure 4.51 A sample of <i>MOLup</i> scatter plot.....	150
Figure 4.52 <i>Pareto Front</i> solution set table: the tabular format contains all solutions that form the <i>Pareto Front</i> .....	151



Figure 4.53 Selecting a whole-farm land-use management based on the attribute of each paddock of the whole-farm .....	152
Figure 4.54 A sample of <i>Pareto Front</i> .....	152
Figure 4.55 A sample of <i>MOLup</i> spread tables .....	155
Figure 4.56 A sample of paddock <i>LuM</i> settings table .....	155
Figure 4.57 Pre-selected land-use management options for <i>Gully</i> .....	156
Figure 4.58 A map sample showing the whole-farm land-use management result..	157
Figure 4.59 <i>MOLup</i> objects .....	158
Figure 4.60 <i>MOLup</i> opening dialog box .....	160
Figure 4.61 <i>MOLup</i> main control .....	161
Figure 4.62 <i>MOLup</i> system .....	161
Figure 4.63 Creating a new farm setting by using existing farm data .....	162
Figure 4.64 <i>MOLup</i> main page .....	163
Figure 4.65 Example of updating a screen of a farm .....	163
Figure 4.66 Setting databases .....	164
Figure 4.67 Pre-processing rainfall data to predict crop production and environmental impact distribution .....	164
Figure 4.68 Menu for pre-processing historical rainfall to adapt crop production and environmental impact .....	165
Figure 4.69 <i>MOLup</i> processes .....	166
Figure 4.70 A sample of the commodity price dialog box .....	167
Figure 5.1 An example of the combinatorial set of land management paddocks for the Muresk farm .....	169
Figure 5.2 Muresk farm (Drysdale 2002) .....	170
Figure 5.3 Histograms of Muresk rainfall by season type .....	171
Figure 5.4 Muresk rainfall; the dotted lines represent two standard deviations from the mean .....	172
Figure 5.5 2006 monthly rainfall versus Average monthly rainfall (1920-2005) (only up to October 2006 data available at point of analysis) .....	175
Figure 5.6 The estimated probability (confidence) of a season to occur as the year progresses .....	177
Figure 5.7 The filtering of season types as the year progresses .....	178
Figure 5.8 The total rainfall in 10 days versus daily rain of the year 2006 .....	178

Figure 5.9 A sample of Land Management Unit analysis for the Muresk Farm; Source: Warren (2007) .....	182
Figure 5.10 The original Muresk paddocks overlay on the LMU defined by Warren (2007) .....	184
Figure 5.11 Cash and pool price charts prices of different crop products.....	186
Figure 5.12 <i>MOLup</i> results for January with all estimated whole-farm management options (selected option <i>WLuM</i> <sub>14817</sub> ) .....	191
Figure 5.13 <i>MOLup</i> result showing the paddock management choices for each paddock .....	192
Figure 5.14 Histogram of the selected whole-farm options objective functions: profit versus environmental impact.....	193
Figure 5.15 The spread tables.....	193
Figure 5.16 A close look at the <i>Pareto Optimal</i> for whole-farm management solutions provided for 01 January 2006 .....	195
Figure 5.17 Paddock <i>LuM</i> settings for whole-farm management options <i>WLuM</i> <sub>14870</sub> and <i>WLuM</i> <sub>14817</sub> .....	195
Figure 5.18 Paddock <i>LuM</i> settings for whole-farm management options <i>WLuM</i> <sub>14833</sub> and <i>WLuM</i> <sub>14873</sub> .....	196
Figure 5.19 <i>MOLup</i> results for 31 <sup>st</sup> March 2006 with whole-farm management option number <i>WLuM</i> <sub>4575</sub> .....	198
Figure 5.20 Preselected paddock land-use management for 31 <sup>st</sup> March 2006 .....	199
Figure 5.21 A close look at the <i>Pareto Optimal</i> for whole-farm management options for 31 <sup>st</sup> March 2006 .....	200
Figure 5.22 Restricting the initial soil water at different sowing date .....	201
Figure 5.23 <i>MOLup</i> results for 31 <sup>st</sup> March 2006 after initial soil water constraint has been set (option number <i>WLuM</i> <sub>7650</sub> ).....	202
Figure 5.24 Preselected paddock management choices for each paddock as at 31 <sup>st</sup> March 2006 after initial soil water constraint has been set .....	203
Figure 5.25 A close look at the <i>Pareto Optimal</i> for whole-farm management options at 31 <sup>st</sup> March 2006, when water is the limiting factor (magenta) until 15 <sup>th</sup> June 2006 and when water is not the limiting factor (blue) .....	204
Figure 5.26 The total rainfall from 26 <sup>th</sup> April - 31 <sup>st</sup> May for the last 86 years (1920- 2005).....	205

Figure 5.27 <i>MOLup</i> results for April with whole-farm management option number <i>WLuM<sub>2444</sub></i> .....	207
Figure 5.28 <i>MOLup</i> results for April with whole-farm management option number <i>WLuM<sub>2353</sub></i> .....	208
Figure 5.29 Preselected <i>LuMs</i> for <i>Gully</i> , <i>Jangelling</i> and <i>Airstrip</i> on 25 <sup>th</sup> April 2006 .....	209
Figure 5.30 Preselected <i>LuMs</i> for <i>Fine View</i> , <i>Muresk-1</i> and <i>Siding</i> on 25 <sup>th</sup> April 2006 .....	210
Figure 5.31 Preselected <i>LuMs</i> for <i>Gully</i> , <i>Jangelling</i> and <i>Airstrip</i> paddocks at 28 <sup>th</sup> May 2006.....	212
Figure 5.32 <i>MOLup</i> results for 28 <sup>th</sup> May 2006 with whole-farm management option number <i>WLuM<sub>292</sub></i> .....	213
Figure 5.33 Preselected <i>LuMs</i> for <i>Fine View</i> , <i>Muresk-1</i> and <i>Siding</i> paddocks at 28 <sup>th</sup> May 2006.....	214
Figure 5.34 Preselected <i>LuMs</i> for <i>Fine View</i> , <i>Muresk-1</i> and <i>Siding</i> on 28 <sup>th</sup> June 2006 .....	218
Figure 5.35 The total rainfall from the 15 <sup>th</sup> September - 31 <sup>st</sup> December for the last 86 years (1920-2005).....	219
Figure 5.36 Spot price of different crop products .....	220
Figure 5.37 <i>MOLup</i> results for 15 <sup>th</sup> September 2006 using simulated spot cash prices .....	221
Figure 5.38 <i>MOLup</i> results for 15 <sup>th</sup> September 2006 using edited spot cash prices .....	222
Figure 5.39 Summary of the case study results.....	224
Figure 6.1 Foot print of the changes that happen during the year.....	227
Figure 6.2 Pre-selected land-use management options for <i>Gully</i> .....	233

## TABLE OF TABLES

Table 2.1 Environmental impact caused by agricultural products (Jolliet <i>et al.</i> 2003) .....	13
Table 2.2 A classification of farm business risk (Australian Banker's Association Inc. 2004).....	18
Table 2.3 GIS integrated systems.....	22
Table 2.4 Application of MADM methods in natural resource management .....	31
Table 2.5 Applications of MODM methods in natural resources management.....	42
Table 2.6 Applications of uncertainty methods in natural resources management....	50
Table 3.1 Types of different approaches in employing <i>memory</i> and <i>tag</i> .....	76
Table 3.2 Different types of MOEA approaches.....	79
Table 4.1 Crop modules in APSIM and relevant references (Keating <i>et al.</i> 2003)..	110
Table 4.2 The classification of eight season types based on the Beverley Shire rainfall between 1900 - 2002 (see Table 4.3 for results).....	113
Table 4.3 Allocation of individual years to season types based on Beverley rainfall .....	113
Table 4.4 Wheat products specifications (AWB 2005; ProFarmer 2005).....	116
Table 4.5 Possibility Likelihood Linguistic scale description.....	121
Table 4.6 Farming processes that causes environmental effects.....	129
Table 4.7 GEDT sample input and output for wheat crop production .....	132
Table 5.1 Statistical information of Muresk rainfall (1920-2005) .....	173
Table 5.2 Classification of Muresk rainfall (1920-2005).....	174
Table 5.3 Monthly rainfall in 2006 and the average monthly rainfall.....	175
Table 5.4 Weather changes constantly and uncertainty surrounding season type narrows as the year progresses .....	177
Table 5.5 LMU description (Warren 2007).....	180
Table 5.6 Aggregated LMU (Fisher, personal communication) .....	183
Table 5.7 Paddock summary information .....	183
Table 5.8 Summaries of different crop type and the average cost of seed and seeding rates .....	184
Table 5.9 Crop quality parameters (refer to Table 2.4).....	185
Table 5.10 Cash and pool prices utilised for the case study.....	187

Table 5.11 Setting a scenario.....	189
Table 5.12 Sample of environmental impact GWP results for different paddocks..	194
Table 5.13 Conditional probability when the summer rain is known .....	197
Table 5.14 The subjective assumption that the year has a wet summer but dry early season period .....	201
Table 5.15 The subjective assumption of the likelihood occurrence of a season type as at the end of April .....	206
Table 5.16 Crop variety decision for different paddocks.....	206
Table 5.17 The conditional probability of the seasonal type based on the accumulated rain during summer and early season period of 2006.....	211
Table 5.18 Decision on farming activities at the end of May 2006 .....	215
Table 5.19 Subjective assumptions of the likelihood of occurrence of seasonal types at the end of June (28 <sup>th</sup> June 2006).....	216
Table 5.20 Farming activities decision at the end of June 2006 .....	217
Table 5.21 The subjective assumptions of the likelihood of occurrence of the seasonal type at 14 <sup>th</sup> September 2006.....	219

## TABLE OF PSEUDO CODE

Pseudo-code 4.1 A sample of performing Monte Carlo on a model $G(x)$ , which has various numbers of input variables with uncertainty elements (Figure 4.18).....	106
Pseudo-code 4.2 Random number generator with seeder .....	108
Pseudo-code 4.3 Obtaining the crop production distribution based on the probability or possibility value (see Section 4.3.4.3).....	115
Pseudo-code 4.4 Obtaining the probability of a season type using current information and perform aggregation on the crop production for a data driven process .....	120
Pseudo-code 4.5 Obtaining the possibility likelihood of the season and perform aggregation on the crop production for a knowledge driven process.....	124
Pseudo-code 4.7 Obtaining the estimation of the spot market price .....	125
Pseudo-code 4.9 Estimate spot market price using subjective information .....	127
Pseudo-code 4.10 Recursive process to perform permutation .....	135
Pseudo-code 4.11 Aggregating whole-farm objective functions .....	141
Pseudo-code 4.12 Simple way of obtaining <i>Pareto Optimal</i> points .....	143
Pseudo-code 4.13 Obtaining <i>Pareto Optimal</i> points.....	146
Pseudo-code 4.14 Performing histogram .....	154

**LIST OF ACRONYMS**

<i>ACO</i>	<i>Ant Colony Optimisation</i>
<i>ACS</i>	<i>Ant Colony System</i>
<i>AFFA</i>	<i>Agriculture, Fisheries, and Forestry - Australia</i>
<i>APSIM</i>	<i>Agricultural Production System Simulator</i>
<i>ASCII</i>	<i>American Standard Code for Information Interchange</i>
<i>AVSWAT</i>	<i>ArcView SWAT</i>
<i>DDE</i>	<i>Dynamic Data Exchange</i>
<i>DSP</i>	<i>Discrete Stochastic Programming</i>
<i>DNA</i>	<i>Deoxyribonucleic Acid</i>
<i>DSS</i>	<i>Decision Support System</i>
<i>EA</i>	<i>Evolutionary Algorithm</i>
<i>EI</i>	<i>Environmental Impact</i>
<i>ENPV</i>	<i>Expected Net Present Value</i>
<i>EP</i>	<i>Evolutionary Programming</i>
<i>ES</i>	<i>Evolutionary Strategies</i>
<i>GA</i>	<i>Genetic Algorithm</i>
<i>GEDT</i>	<i>Grains Environmental Data Tool</i>
<i>GIS</i>	<i>Geographic Information Systems</i>
<i>GI</i>	<i>Gross Income</i>
<i>GM</i>	<i>Gross Margin</i>
<i>GE</i>	<i>Genetic Programming</i>
<i>GP</i>	<i>Goal Programming</i>
<i>GPFarm</i>	<i>Great Plains Framework for Agricultural Resource Management</i>
<i>GUI</i>	<i>Graphical User Interface</i>
<i>LMU</i>	<i>Land Management Unit</i>
<i>LP</i>	<i>Linear Programming</i>
<i>LU</i>	<i>Land-use</i>
<i>LUDSS</i>	<i>Land-use Decision Support System</i>
<i>LuM</i>	<i>Land-use Management</i>
<i>MA</i>	<i>Memetic Algorithm</i>

<i>MADM</i>	<i>Multiple Attribute Decision-Making</i>
<i>MAUT</i>	<i>Multi Attribute Utility Theory</i>
<i>MAVT</i>	<i>Multi Attribute Value Theory</i>
<i>MCDM</i>	<i>Multi-Criteri Decision-Making</i>
<i>MIDAS</i>	<i>Model of an Integrated Dryland Agricultural System</i>
<i>MODM</i>	<i>Multiple Objective Decision-Making</i>
<i>MOEA</i>	<i>Multiple Objective Evolutionary Algorithm</i>
<i>MOLup</i>	<i>Multiple Objective Land-use planning</i>
<i>MOTAD</i>	<i>Minimisation of Total Absolute Deviations</i>
<i>MP</i>	<i>Mathematical Programming</i>
<i>MUDAS</i>	<i>Model Of An Uncertain Dryland Agricultural System</i>
<i>Pt</i>	<i>Profit</i>
<i>QP</i>	<i>Quadratic Programming</i>
<i>QRP</i>	<i>Quadratic Risk Programming</i>
<i>REI</i>	<i>Reversed Environmental Impact</i>
<i>SA</i>	<i>Simulated Annealing</i>
<i>SDP</i>	<i>Stochastic Dynamic Programming</i>
<i>SDSS</i>	<i>Spatial Decision Support Systems</i>
<i>SEU</i>	<i>Subjective Expected Utility</i>
<i>SPR</i>	<i>Stochastic Programming with Recourse</i>
<i>SQL</i>	<i>Standard Database Query Language</i>
<i>SWAT</i>	<i>Soil &amp; Water Assessment Tool</i>
<i>TS</i>	<i>Tabu Search</i>
<i>TuGAs</i>	<i>Tabu Search-Genetic Algorithm Search</i>
<i>VEGA</i>	<i>Vector Evaluated Genetic Algorithm</i>
<i>WA</i>	<i>Western Australia</i>
<i>WLuM</i>	<i>Whole-farm (Land-use) Management Option</i>



This page is intentionally blank

## CHAPTER 1

### INTRODUCTION

#### 1.1 Problem Formulation

Over 80 percent of mankind's diet contains seeds of plants, making agriculture crucial to human survival. For many centuries, farmers associated the concept of "successful farming" with increasing their production and profit, either by expanding cultivated areas, migrating to foreign lands or applying chemicals to the land. This concept ignored the impact that such activities pose on the environment. Nowadays, "successful farming" encompasses farming with the purpose of obtaining high production and profitability, while keeping the farm sustainable from an ecological, economical and social point of view (Kantor 1999).

Sustainable farming systems require careful land-use planning to increase profits while maintaining healthy soil structure and protecting the environment by recycling natural resources and conserving energy (Gold 1999). To this end, sustainable farm land planning can be enhanced with a Land-use Decision Support System (LUDSS). Within the context of this research, land-use planning includes the tactical planning of farmland activities adopting land-uses that optimise the whole-farm objectives while taking into account the consequences that such uses pose in relation to environmental, economic and social/political concerns.

Most land-use planning is restricted either to micro- or macro-level planning with little effort made to integrate the two levels (Rao 2000). In most cases, land-use will be classified by micro-level indicators based on the characteristics of the land (i.e. soil quality, water holding capacity, nutrient availability, salinity, topography) and its recent history of use. This is done to bring the methods and procedures closer to the individual unique level where land-use characteristics are less heterogeneous. Dealing with each level in isolation can lead to inappropriate decision-making, and although methods to reconcile the two levels of planning have not yet been fully developed, it is clear that the output of micro-level analyses can contribute significantly to macro-level studies (McGregor *et al.* 2001).

Land-use (farm) planning is a dynamic process. The “optimum” land-use at a certain point in time may not be the same at another time, even over a short time period - a week or even a day. Such a dynamic nature makes the process rife with uncertainty and risk due to the changes in circumstances of variables driving the decision-making process (e.g. climate, markets, pests or even the fertiliser applied to the paddock). The current condition dictates the possible future farm management options.

The dynamic environment of an annual farm planning process can be visualised as a cone-like situation where, at the beginning of the sowing year, uncertainty is very high given the inability to foresee how the year is going to turn out from a climatic and economic perspective. At this point in time, farmers have a large number of possible management options available to them. As the year unfolds, the assurance of the climate and economy will reduce the uncertainty with a consequential reduction in possible management options. A key decision for farm managers is what crop type to sow in the growing season. This constraint the paddock from the seeding date for the rest of the growing season.

## **1.2 Background Information**

### **1.2.1 Requirement of a micro level (agricultural) land-use planning system**

Two major elements need to be considered to achieve optimisation in agricultural land-use planning, namely: site-specific management and land-use (spatial) decision support. Site-specific management involves the subdivision of paddocks into units of similar soil characteristics for improved management of crop production variability. Land-use decision support systems are applied to find an optimum farm management option, accounting for constraints such as the availability of machinery, socio-economic and biophysical sustainability of the systems adopted, economic and commercial factors, legal constraints, historical trends and other practical considerations (Pannell 1995).

A successful LUDSS should be able to capture the dynamic environment of the land-use planning process based on integrating spatial data. Geographic information

systems (GIS) are a tool that can be used to this end. GIS deal with the organisation, manipulation, analyses and display of spatial, aspatial and temporal data.

GIS has become a frequent component in Decision Support Systems (DSS) for land-use planning (Suhaedi *et al.* 2002; Watkins *et al.* 1996). Some authors refer to these systems as Spatial Decision Support Systems (SDSS) while others call them Land-use Decision Support System (LUDSS), but nevertheless they are the same. The integration of GIS into DSS increases the capabilities of a common DSS to a highly informative system, capable of versatile techniques including (Ravan 2002):

1. Modeling spatial processes based on geographical constraints;
2. Performing a series of spatial analysis with the purpose of generating new and more meaningful information;
3. Performing interactive, iterative and systematic decision-making procedures based on spatial and aspatial information; and
4. Proposing solutions and their consequences in a text, tabular and graphical format or a combination thereof.

#### 1.2.2 Decision support system

The decision support system required on a farm involves optimisation of the decision objective, as well as the incorporation of the risk and uncertainty, associated with such a dynamic as a farm management planning environment. Within the context of this research, a decision support system (DSS) is defined as a modelling system capable of processing knowledge to produce constructive and valuable solutions to assist in the decision-making process.

The first stage of developing an effective DSS requires an emphasis on proper formulation and construction of the problem objectives, also known as decision objective/s. The decision-maker is required to clearly identify the problem and the decision objectives of the problem at hand so that a suitable optimisation technique can be selected to find a set of optimal solutions for those decision objectives. Due to the complex and uncertain nature of the problem, elements of risk and uncertainty need to be incorporated into the DSS.

Decision-making is generally a complicated procedure, especially when land-use planning is involved. Scientists and farm managers agree that a single objective function problem, such as maximising profit or minimising environmental effect, does not adequately reflect the problem at hand (Fischer *et al.* 1996). Solving farm management problems usually involves determining optimal trade-off solutions between competing objectives, such as maximising profit and minimising environmental impact. These trade-offs are also subject to constraints such as the availability of machinery, socio-economic and biophysical sustainability of the systems adopted, economic and commercial factors, legal constraints, historical trends and other practical considerations (OMAFRA 2002; USDA-NRCS 1997).

After the decision objectives are formulated, suitable approaches need to be selected to help optimise the problem objective. A wide set of tools, ranging from simple mathematical models to complex search models, are available to this end (Fotheringham and Rogerson 1994). Each of these techniques has specific uses that can be matched to the problem under consideration. Popular methods of Mathematical Programming are Linear Programming and Quadratic Programming; but increasingly new search methods, such as Genetic Algorithms, Simulated Annealing, Tabu Search and exhaustive methods, are being adopted.

### 1.2.3 Uncertainty and risk

The terms ‘risk’ and ‘uncertainty’ have been used interchangeably. Knight (p.20 and p.226, 1921) states that in the economic sector “risk refers to a situation where an individual is able to calculate probabilities on the basis of an objective classification of instances” while “uncertainty refers to situations where no objective classification is possible”.

In real world circumstances, risk exists due to imperfect knowledge at the decision-making instance. Imperfect knowledge is not only uncertainty about the dynamic changes that may happen, but also the possible imprecision of the information to be used. Examples of the latter are imprecision in the scientific quantification (von Mises 1978), imprecision in model parameter estimation (Jorgensen 2001) and uncertain decisions (Klauer and Brown 2004). Incidents that are out of the decision-

maker's control include uncertain markets (Holton 2004) and uncertainty in weather (Adger and Vincent 2005).

Western Australian farm management is consistently plagued with risks (Hardaker and Lien 2005). These can be of four main types: production, ecological, labour, financial, market and regulatory risks (Moreddu 2000; Hardaker *et al.* 1997). According to AFFA (2000), risk associated with agricultural production is the most significant, due to weather uncertainty and disease outbreak. Ecological risks are associated with pollution, and changes in climate and natural resources, whereas market risks are associated with the price variability of inputs and outputs. Regularity risk is related to changes in government intervention in agriculture. As such, agricultural risks and uncertainty can be listed as (Hess *et al.* 2005): climatic, natural adversities (i.e. pest, disease outbreak, pollution, and damage) and market prices.

Western Australian farmers operate under a highly uncertain climate (Laughlin and Clark 2000). Aside from climate, other natural adversities posing significant risks to the Australian agricultural sector are pests, weeds, pollution and disease. Therefore it is prudent to incorporate risk and uncertainty factors within the design of a farm-level land-use decision support system.

#### 1.2.4 Graphical user-friendly decision support tool

A recurring theme in the literature on DSS has been the importance of user interface on the usability of the tool and in particular user-friendliness of the software application itself. An effective graphical user interface (GUI) directly affects the usability of the application as it is the point where the user interface interacts with the computation component of the model. The user interface not only initialises the problem but also presents the result of the computation.

### 1.3 Research Objectives

Australian farmers face a wide range of farm management alternatives and the success of each alternative is influenced by factors such as crop type, weather, market price, soil type and other natural adversities.

This research aims to develop a LUDSS designed to support tactical farm decision-making, so that “optimum” land-uses (farm management options) for a particular farm can be chosen in the highly dynamic farming environment of Western Australia. This broad objective requires effective optimisation of agricultural land-use planning through the design and implementation of a LUDSS; and account for the risk and uncertainty associated with farming in WA.

The tactical land-use decision support system will attempt to determine optimum solutions for a farm based on two major objectives: maximising the whole-farm profit, while minimising the environmental effect of the land-use in each paddock. A solution is denoted as a combinatorial set of land management options on each paddock within the whole-farm context. Therefore, the problem at hand can be treated as a combinatorial optimisation problem.

This research investigates the development of an innovative approach for an effective Land Use Decision Support System (LUDSS). This will lead to a hypothesis for further investigation in the future. The following specific objectives are identified:

1. Modeling of decision objectives: This aspect of the research requires identifying factors important in farm management, identifying the problem objectives, and developing a multi-criteria decision-making model which incorporates a trade-off between the competing objectives of maximising production and financial returns, while ensuring the environmental sustainability of the farm system to be adopted;
2. Developing a basic LUDSS model: This aspect of the research requires reviewing different optimisation techniques and identifying suitable optimisation methods for the LUDSS model;
3. Analysis and modelling of risk and uncertainty by assessing different risk analysis techniques and incorporating them into the optimisation model;
4. Building a user interface to allow the model to be used by a wide audience ranging from extension officers to farmers.

#### **1.4 Significance of the Thesis**

This research seeks to construct a prototype Land-use Decision Support System (LUDSS) that integrates spatial information into a decision support system which

account for the multi-criteria nature of the land-use planning in a dynamic agricultural environment. A functional whole-farm DSS model should be able to determine economic and environmental trade-offs on farms, based on the farm management applications operated within (e.g. return on investment, the impact of a decision on the whole-farm).

Numerous DSS have been developed in the past but most fail to completely represent the actual day to day activities of a farm. Two prominent examples are MIDAS and GPFarm. MIDAS (Kingwell and Pannell 1987) is a whole-farm Linear Programming model developed to analyse land-use management decisions in an average season in the eastern Wheatbelt of Western Australia. The model calculates optimal farm management options by maximising profits. The approach requires the model to meet different goals and determines the costs associated with achieving each of these goals (WA Department of Agriculture Undated).

GPFarm simulates and analyses long term farm production plans in terms of their economic and environmental risks associated with their application of farm management inputs (i.e. crop, livestock, water, nutrient and pest management) (USDA-ARS 1998).

The MIDAS and GPFarm models are limited by the adoption of a single objective function and their fixed structure, which means that the solution space is set at the beginning of the processing.

This thesis incorporates a degree of innovation by amalgamating LUDSS into the dynamic farming environment so that it can be used by a farm decision-maker at any time of the year. The model applies an innovative approach that mimics the way in which an agricultural consultant and/or a farm manager would search for optimal solutions at a whole-farm level. That is, it takes into account all the possible elements that influence the decision-making process at different times of the year. It also takes into account uncertain factors associated with the drivers of the farming business. As a consequence, the model incorporates the dynamic changes occurring within a growing season and, as time passes, the associated management options.



## 1.5 Thesis Structure

A work flow diagram, illustrating the structure of this thesis, is presented in Figure 1.1. It shows the relationship between the different sections and chapters of the thesis.

Chapter 2 sets the scene of the whole-farm management framework. This chapter also extensively discusses existing approaches and techniques employed in land-use decision support system models. The chapter concludes with a thorough analysis on the most suitable approach to implement the LUDSS model (Chapters 3 and 4).

Chapter 3 evaluates the viability of introducing Evolutionary Algorithm (EA) approaches as a component of the LUDSS. The chapter then thoroughly discusses the most suitable EA approach for the problem at hand and a prototype for an optimisation model is presented.

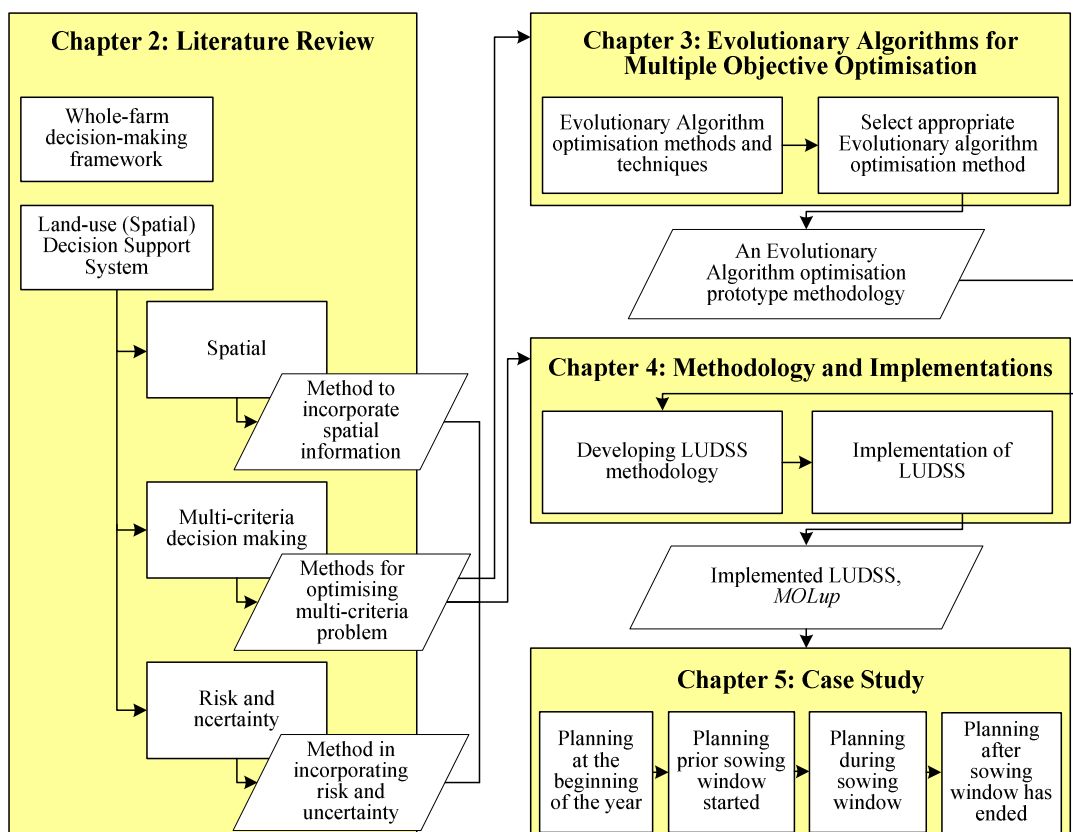

Figure 1.1 Flow diagram of thesis chapters

Chapter 4 discusses the development of the LUDSS, pulling together all the methods, data and information discussed in the previous chapters. This chapter shows how raw data, such as yield, environmental impact, and market price data, are pre-processed based on different weather scenarios. These pre-processed data are then used to forecast the probable yield and market price distributions based on the current weather condition.

Chapter 5 presents the results and analysis of a case study. The case study is carried out at different stages/time of the cropping year, namely: January (assessing), March (planning), April-July (planning/implementation), and July-September (monitoring).

The thesis then concludes in Chapter 6 with a summary of the research and a set of recommendations for further research are proposed.

## CHAPTER 2

### LITERATURE REVIEW

This chapter discusses the two different segments of this research: 1) the whole-farm decision-making framework and 2) approaches and techniques used in land-use decision support system models.

#### 2.1 Whole-Farm-Level Decision-Making Framework

The main purpose of whole-farm-level decision-making is to determine optimum land-use management for the entire farm based on its total set of resources, whilst ensuring the sustainability of the farm (Kemp 1996). The classical description of whole-farm management is shown in Figure 2.1: setting goals, assessing, planning, implementing and monitoring (see Section 2.1.2 for details).

Although the whole-farm management decision-making process involves a set of rules; it is not carried out in a vacuum and is impacted by both external (i.e. markets, weather, and policy) and internal drivers (i.e. finance, labour, machinery and expertise).

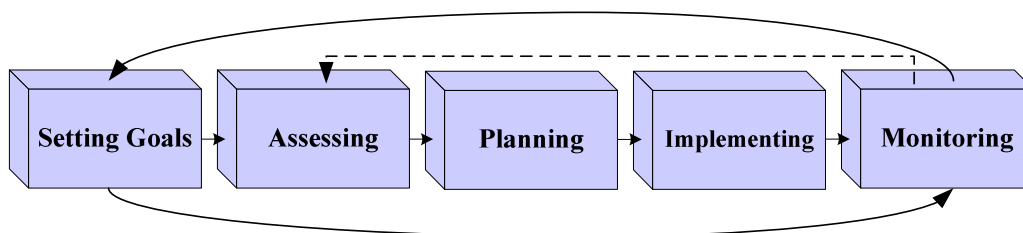

Figure 2.1 Whole-farm management

Essentially, a farm decision-maker is required to have sufficient skill and knowledge in making strategic, tactical and operational decisions in a broad range of fields such as animal science, agronomy, management, machinery and marketing (Hayman 2004). Strategic decision-making is usually long term and concerned with comprehensive planning for the success of the whole-farm. Strategic decision-making includes: decisions on enterprise mix, purchasing extra land, sources of

finance and product and market choices. Tactical decision-making focuses on implementation and determines how the strategic goal(s) will be achieved. This includes: decisions like crop type/variety, the paddock selection the crop will be sown into and the levels of inputs, product modification and current season to marketing plans. Operational decision-making involves the day-to-day decisions including directing labour, spraying, sowing and harvesting decisions (Hayman 2004).

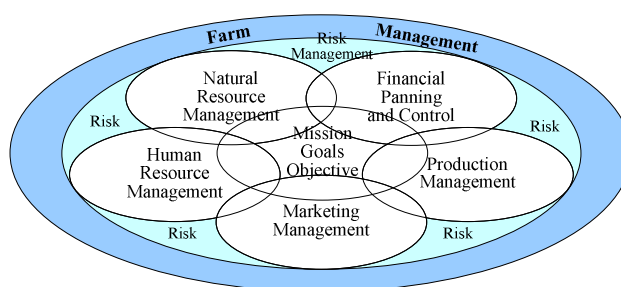

Figure 2.2 The components of whole-farm planning;  
Source: Australian Banker's Association Inc. (2004)

Whole-farm decision-making can be categorised as shown in Figure 2.2. At all levels there is considerable risk and uncertainty. The different farm management categories (Australian Banker's Association Inc. 2004):

1. Natural resource management is seen as the core of the farm. The preservation and enhancement of natural resources means the prospect of a healthy, sustainable farm in the future. Good management helps to prevent or even reverse environmental damage and in effect help preserve natural resources.
2. Farm financial management is seen as the key to success for many farms. Good financial management uses financial resources wisely, ensuring that at any given time there are enough funds to perform the required operations.
3. Human resource management includes the ability of managers to manage themselves, their staff and the ability to lead and develop a work plan effectively.
4. Enterprise management aims to manage the crop and livestock enterprises on the farm; usually with the objective of increasing farm productivity and profitability.
5. Marketing management is the marketing of farm products to ensure overall farm profitability.
6. Risk management: Farming decisions are frequently performed in a dynamic risky and uncertain environment mainly due to the constant unpredictable

changes in such things as market prices, production, seasonal conditions and government policies.

### 2.1.1 The big picture: sustainable farming

Sustainable farming infers trade-offs between economic stability, environmental and social outcomes (McMaster and McMaster 2002). Sustainable whole-farm planning is a complete approach to farm decision-making that brings in the entire farm and its resources, and considers alternative solutions and possible impacts (Kemp 1996). It involves choosing the most suitable *whole-farm land-use plan* based on available resources (i.e. soil) and weather and market conditions, to produce farm products such as crops and livestock; hence profit and the associated environmental and social impacts.

The value of crop production is determined by the amount produced, its quality and price received in the market. The environmental impact of farming operations can be categorised into the following six categories (Narayanaswamy *et al.* 2005)<sup>1</sup>:

1. Global warming: The release of global warming gasses (e.g. carbon dioxide and nitrous oxide) into the atmosphere.
2. Human toxicity: The impact on human health caused by the use of pesticides and herbicides, fumigants and rodent repellents.
3. Atmospheric acidification: This impact is caused by the release of acidic gases, (e.g. sulphur dioxide and nitrogen oxides) from the burning of fossil fuels and sulphuric acid emissions from fertiliser production.
4. Terrestrial and aquatic eco-toxicity: Toxic chemicals (e.g. pesticides, chlorinated solvents and heavy metals) can harm living organisms in water or on land.
5. Eutrophication: Due to the levels of nitrates and phosphates that find their way into fresh and marine waters, which can lead to nutrient build-up in waterways.
6. Resource energy: This impact is caused by mineral extraction and non-renewable energy consumption, such as the fuel energy consumed in farming activities.

Table 2.1 summarises the link between damage categories, environmental impact and farm practices.

---

<sup>1</sup> Their analysis adopted a life cycle approach to measuring impact so included environmental impact in the production of farm inputs and the off farm impacts.

Table 2.1 Environmental impact caused by agricultural products (Jolliet *et al.* 2003)

Damage Categories	Environmental Impact		Farm Practices
Human health	<ul style="list-style-type: none"> <li>▪ Human toxicity</li> <li>▪ Respiratory effects</li> <li>▪ Ionizing mediation</li> </ul>	<ul style="list-style-type: none"> <li>▪ Ozone layer depletion</li> <li>▪ Photochemical oxidification</li> </ul>	<ul style="list-style-type: none"> <li>▪ Application of pesticides, herbicides, fumigants and rodent repellents</li> </ul>
Ecosystem quality	<ul style="list-style-type: none"> <li>▪ Ozone layer depletion</li> <li>▪ Photochemical oxidification</li> <li>▪ Aquatic eco-toxicity</li> <li>▪ Terrestrial eco-toxicity</li> </ul>	<ul style="list-style-type: none"> <li>▪ Aquatic acidification</li> <li>▪ Aquatic eutrophication</li> <li>▪ Terrestrial acidification</li> <li>▪ Land occupation</li> </ul>	<ul style="list-style-type: none"> <li>▪ Excess fertiliser application</li> <li>▪ Spraying toxic chemicals</li> </ul>
Climate change	<ul style="list-style-type: none"> <li>▪ Global Warming</li> </ul>		<ul style="list-style-type: none"> <li>▪ Transportation</li> <li>▪ Artificial fertiliser application</li> <li>▪ Stubble burning</li> <li>▪ Soil disturbance</li> </ul>
Resources	<ul style="list-style-type: none"> <li>▪ Non-renewable energy</li> </ul>	<ul style="list-style-type: none"> <li>▪ Mineral extraction</li> </ul>	<ul style="list-style-type: none"> <li>▪ Transportation and</li> <li>▪ Mineral extraction for fertiliser production</li> </ul>

Farm decision-making related to land-use occurs at two levels: whole-farm and individual paddock. A farm is usually divided into a number of paddocks. Traditionally, these paddocks are defined based on manageable sizes, natural factors (i.e. river, soil types and topography), as well as, pragmatic factors like farm machinery operations, which generally prefer regular boundaries. However, new research is suggesting alternative methods to subdivide farm into homogenous land management units (LMU) (Warren 2007). The LMUs in this case are formed based on their similarity in soil and topographic properties.

Paddock-level decisions are generally focused on tactical decisions such as: crop type, sowing date, crop variety, fertilising options, spraying options, and marketing. The whole-farm decision-making process links individual paddock decisions and farm land resources (such as available finance, machinery and labour) and external drivers such as markets and policy.

In practice, tactical whole-farm decision-making can be represented simply as a narrowing cone (Figure 2.3). Typically, at the beginning of the year, farmers have a large range of possible land-use and production options, but the decision-making environment operates under great uncertainty. As the growing season progresses, the range of options decreases as key decisions are made and implemented. For instance, once the crop is sown the decision-making frame reduces to concentrate on tactical

production and marketing decisions. As subsequent decisions are made the decision-making frame again reduces.

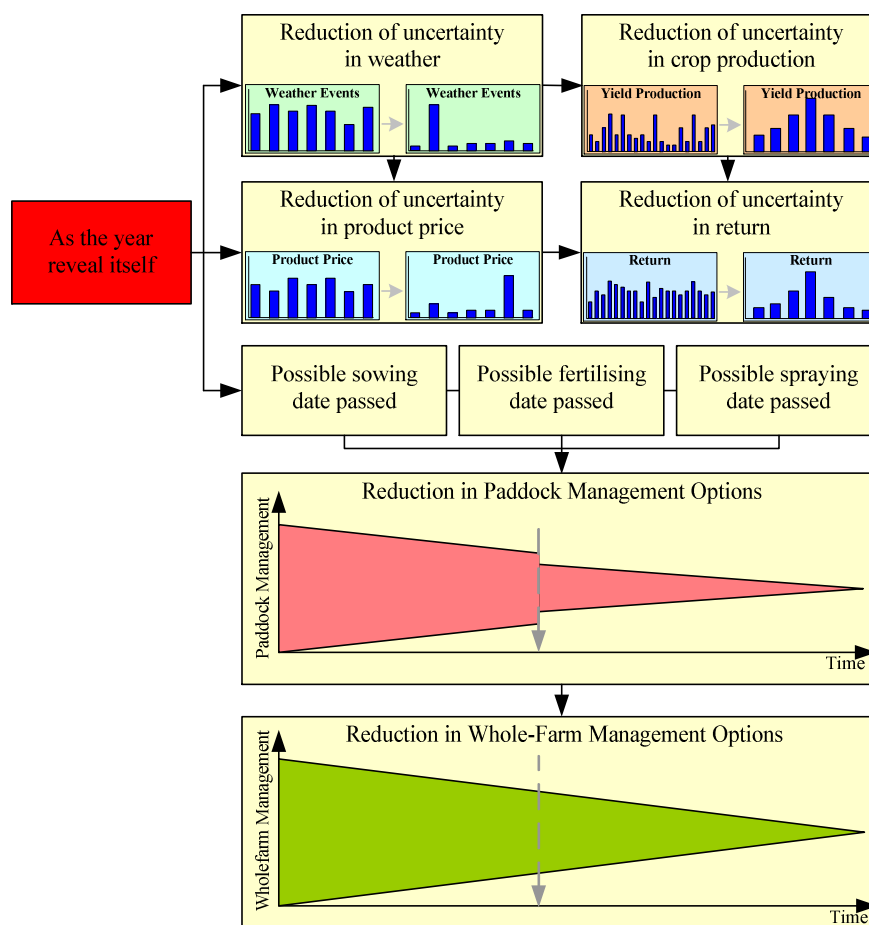

Figure 2.3 Foot print of the changes that happen during the year

As the year reveals itself, it produces two types of outcomes: reduction of uncertainty and the passing of the last possible dates to perform activities. The latter causes the reduction of the number of whole-farm management alternatives (Figure 2.3). Figure 2.3 illustrates that:

1. As time passes by, both weather and market insecurity diminish slowly.
2. Weather is a significant determinant of crop production. As a consequence, the reduction in weather uncertainty helps enhance yield estimation.
3. As the overall picture of the market and weather for the year starts to reveal itself, it enables the producer to more reliably predict production and returns. In effect, the uncertainty associated with expected revenue is reduced through the year, increasing the farmer's confidence in predicting whole-farm outcomes.

4. As the year reveals itself, time becomes another factor of farm management. Accordingly, a reduction of the paddock management options trims down the whole-farm management options too. Take for instance the sowing date. Once the acceptable sowing date for a particular crop (i.e. canola) has passed, then the number of land-use options is reduced. A similar situation is also true for other time critical management options, such as spraying and applying fertilisers.
5. When a decision for a land-use option within a paddock has been implemented, this decision becomes a constraint. In effect, the decision dramatically reduces the paddock management alternatives. Subsequently, the reduction of the paddock management alternatives induces a decrease in the whole-farm management alternatives.

### 2.1.2 Components of the farm management processes

There are a number of components in the classical whole-farm management decision-making process (see Figure 2.1). These commence with setting the mission, goals and objectives followed by the assessment stage, which audits the assets and liabilities of the business. The information collected in the assessment phase is then fed into the planning stage to develop strategies, which make the best use of the farming resources including financial, marketing, environmental and social. A number of alternatives are formed and evaluated in this phase and these take into account parameters, such as the time of the 'break of season'. The penultimate stage is implementing the selected farm plan. Once a decision has been implemented, a regular monitoring process is established to detect any problems or movements from the plan that may occur. The information obtained during the monitoring phase is then used to assess and plan alternatives that may need to be undertaken to ensure the success of the farm business. The cycle of assessing-planning-implementing and monitoring is iteratively performed throughout the growing season.

#### 2.1.2.1 Setting farm objectives and goals

A farm business should work towards a clear mission. A mission is the big picture that summarises a vision and it establishes a broad commitment to reach the stated vision. Missions are materialised by a goal-setting process to form concrete short-term goals and long-term objectives that support the overriding vision and mission of the business (Jones and Fogleman 2005). Objectives are usually broad statements



concentrated on the farm business aims for realising the mission (Groover and Roberts 2000); whereas, goals are a set of actions that need to be performed to achieve the objectives (Pierce and Parcell 1999). Therefore, goals and objectives are focal points when making management decisions, especially during uncertain circumstances (Doye 2005). For instance: the mission of the farm might be to run a sustainable farm business; while the objectives might be to obtain the maximum whole-farm profit whilst minimising the whole-farm environmental impact; and the goals would be to determine the best land-use and management to achieve the objective and mission.

Goals and objectives are not set simply from a business point of view. Rather, they are formed based on the influences of facts, beliefs and values of the business, and family and personal points of view (Figure 2.4). Facts are generally known with certainty (Joerger 1999), such as financial position, assets, past crop and animal performance. A belief is typically the way that we perceive reality, such as how the farmer sees the year is developing. Values are ideals of reality, like what a farmer thinks his farm is supposed to be (Joerger 1999). The synthesis of facts, beliefs and values will determine how the business operates. The set of objectives are usually static, but goals might change, due to unexpected changes in financial arrangements, economic conditions, family status, the level of knowledge, beliefs, values and other factors (Joerger 1999).

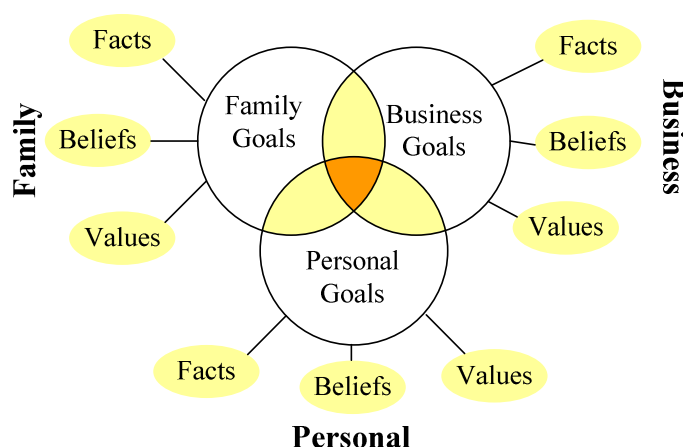

Figure 2.4 Influences on goal setting; Source: Joerger (1999)

#### 2.1.2.2 Assessment

Assessment is a stage where the farmer collects and assesses information to be used for decision-making. This involves drawing together information about the current status of the available farm resources and their associated weaknesses. These include: human resources, farm physical resources, financial resources, social capital, the market and natural resources.

Land quantity and quality is one vital farm asset; for farm resources are generally the physical resources of the farm that can be obtained readily. For example land, water, access roads, size and location of existing buildings, arable and non-arable areas (Janke 2000). Ideally, a thorough land suitability assessment based on soil type, paddock sizes, land contour, land type, previous history, access to workers, physical structures and machinery, would allow a farmer to assess the productive capability of the farm. There should be questions such as: has the soil been tested lately? Which areas are arable and non-arable? What is the landscape (i.e. flat, undulating, crest or depression)? In the process, a farmer may also identify problems, like soil erosion in the paddocks, prominent water logging areas and previous weed type infestations (Barao and Hughes 1999). The output from this phase is a comprehensive picture of the farm via soil maps, soil test results, management histories, as well as, inventories of assets such as stock, machinery and buildings.

There is a need to integrate internal and external information (e.g. markets or weather) to the farm business. This involves both historical information, as well as, future projections for markets and weather.

Generally, managing a farm business involves risks related to natural resources, production, financial, marketing, legal and social, and human resources aspects of the business, as shown in Table 2.2. Understanding and devising strategies to deal with it is crucial to ensure optimal business and environmental outcomes.

Table 2.2 A classification of farm business risk  
(Australian Banker's Association Inc. 2004)

Risk Types	Risk Exposure
Production risk	<ul style="list-style-type: none"> <li>▪ Drought</li> <li>▪ Flood</li> <li>▪ Frost</li> <li>▪ Disease</li> <li>▪ Pest attack</li> <li>▪ Weeds</li> </ul>
Price-market risk	<ul style="list-style-type: none"> <li>▪ Price risk</li> <li>▪ Exchange rate</li> <li>▪ Competitors</li> <li>▪ Demand/supply</li> </ul>
Natural resource risk	<ul style="list-style-type: none"> <li>▪ Soil (i.e. salinity, erosion)</li> <li>▪ Ground water (i.e. contamination)</li> <li>▪ Balance in ecology</li> </ul>
Financial risk	<ul style="list-style-type: none"> <li>▪ Interest rate changes</li> <li>▪ Equity drops</li> <li>▪ Increase of production cost</li> <li>▪ Profitability plummet</li> </ul>
Legal and social risk	<ul style="list-style-type: none"> <li>▪ Income programs</li> <li>▪ Tax and environmental policies</li> </ul>
Human resource risk	<ul style="list-style-type: none"> <li>▪ Labour and management function</li> <li>▪ changes in individual objectives</li> <li>▪ Health risk</li> </ul>
Technological risk	<ul style="list-style-type: none"> <li>▪ Assets may become obsolete</li> <li>▪ Changes in technologies</li> </ul>

### 2.1.2.3 Planning, decision-making and implementation

Planning involves establishing a future pathway for the business based on the vision, objectives and goals set by the management, and based on the information collected in the assessment phase (as illustrated in Figure 2.1).

Early in the planning phase the decision-maker is required to synthesise a considerable amount of information - much of it uncertain (Figure 2.5). Initial plans will often have considerable amounts of flexibility built into them, but as the season unfolds and more market and weather information becomes available a more solid plan evolves.

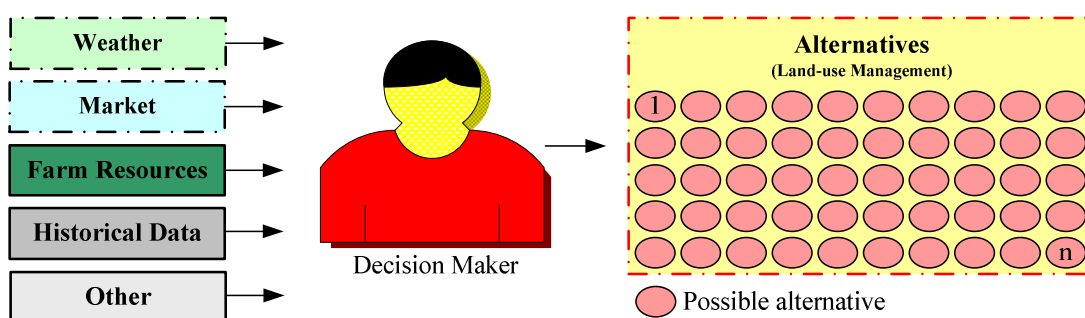

Figure 2.5 Planning at the beginning of the year

A key decision point is the combination of crop to be sown. Once this decision has been made, the land-use is set and the degrees of flexibility open to the decision-maker decreases (Figure 2.6). The decision space then relates to decisions on crop husbandry (i.e. fertilising, spray, etc) and marketing, which are linked to uncertain

factors like weather and market. Weather and markets are dynamic elements that require planning and become an ongoing process in order to facilitate the dynamic nature of the changing world. Therefore, from time to time the plan needs to be altered based on unexpected changes in factors experienced in the agricultural environment.

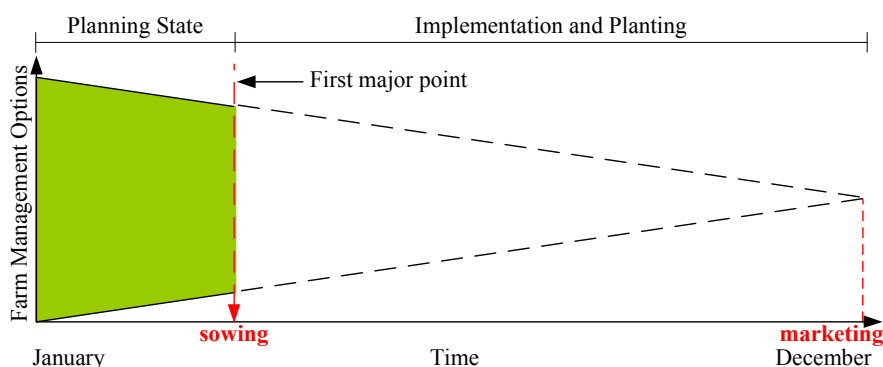

Figure 2.6 Schematic representation of the planning period

In farming, decision-making is performed all through the growing season. During decision-making, all available information (i.e. current weather forecast, market condition and other factors) is used to assist in searching for the best solutions by considering the advantages and disadvantages of the alternative solutions. Alternatives are usually considered based on the profitability, assessed risk and environmental impact of the management option. A farmer needs to understand the interrelationship between the information variables, as well as, acknowledge the correlation between the alternatives. In most cases, the decision involves the need to assess trade-offs between the objectives set. Decisions are often made under pressure, which means the entire range of options are not necessarily considered (Mendola 2005; Duflo 2003). Farmers may use decision tools to help determine the best land-use. These range from simple financial and physical budgets through to sophisticated models that account for multiple objectives. These are discussed in more detail in Chapter 3.

Once decisions are made, implementation occurs. Implementation is putting the agreed plan into action - it involves decision-making, but is primarily the processes of turning a plan into action.

#### 2.1.2.4 Monitoring

As discussed earlier (Section 1.2.3), most farm production is impacted by factors beyond the control of the manager (Janke and Freyenberger 1997). Consequently, it is rare that circumstances turn out exactly as planned. Typically, during the season it is necessary to make numerous adjustments to fine-tune the farm plan chosen. Monitoring performance against the adopted plan is therefore, a crucial stage in farm management.

The objective of monitoring is to identify any possible early warning indicators and make the necessary adjustments to the chosen plan. Such indicators relate to crop and animal performance, weather and markets. This can be done by subjective and/or objective assessment and by monitoring external media related to markets and weather.

The information gained during monitoring allows the farmer to perform an analysis against historical records, but as the season progresses farmers gain more confidence in forecasting the likely outcome from their decisions and hence the future sustainability of their business. During the monitoring process, the farm business is basically undertaking a series of mini assessment sessions. The knowledge gained from the monitoring session will then feed information to the farm management team to support short-term planning and decision-making.

## **2.2 Land-Use (Spatial) Decision Support System**

A Land-use (Spatial) Decision Support System (LUDSS) is a decision aid, which takes the spatial context into consideration to facilitate decision-making about land-use. The study of decision aids, to assist with problem solving, has been a key decision science research topic for the last decade (Mateu 2002).

To be effective, a LUDSS must account for the spatial nature of the problem; whilst at the same time, be able to handle the multiple objective and uncertain nature of the decision space. The remainder of this chapter will evaluate the techniques that others have used in land-use decision-making with a focus on those that incorporate multiple objectives, risk and uncertainty.

### 2.3 The Spatial Element of LUDSS

There have been numerous attempts to integrate spatial information with other tools since the early 1990's (Anselin 1992; Goodchild *et al.* 1992). Lilburne (1996) categorised Geographical Information System (GIS) integration approaches into eight broad classes (Figure 2.7): standalone, loose, tight, merged, enhanced, customised, client/server and framework.

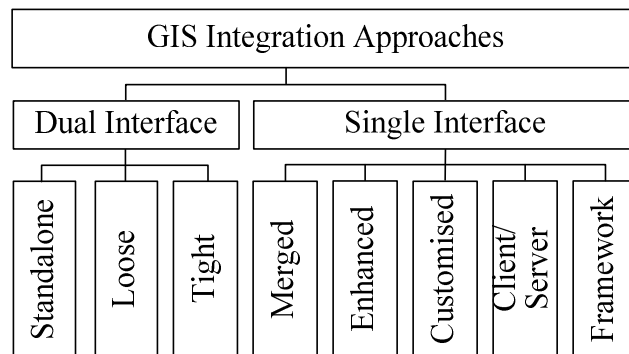

Figure 2.7 Integration approaches of spatial information

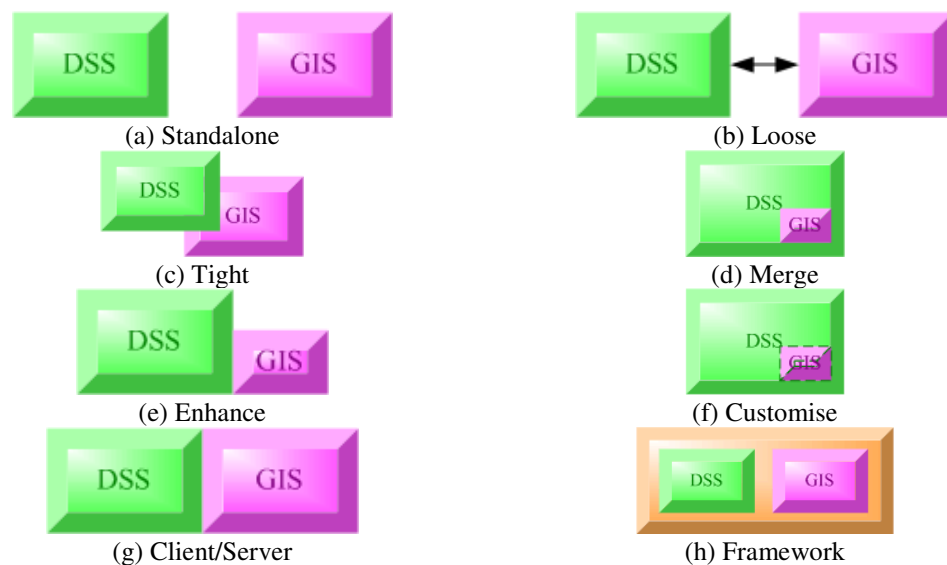

Figure 2.8 GIS integration approaches; Source: Lilburne (1996)

The standalone, loose and tight integration approaches are very similar, as they keep two independent interfaces (Figure 2.8). In the standalone integration approach, the Decision Support System (DSS) and GIS work separately and data transmission between them is carried out manually. In the loose integration approaches, data interchange is performed by using a medium, such as ASCII files, without a common user interface. On the other hand, the tight integration approach provides direct

access to data storage, for example utilising database SQL (Standard Database Query Language) calls within one of the systems. Table 2.3 shows application examples of the different integration approaches.

Table 2.3 GIS integrated systems

Integration	Purpose	Citation
Standalone	GIS employed to obtain information for analysing preliminary options for AHP model	Mendoza <i>et al.</i> (2002b, a)
Loose	Decision Support tool for Forest management planning tool in Belgium	Ducheyne (2003)
Customised	AVSWAT - an extension in ArcView as a tool for the watershed control of point and non-point source pollution	Dutta (2000); Di Luzio <i>et al.</i> (2000)
Enhanced	Enhancing the GRASS GIS with neural network routine.	Muttiah <i>et al.</i> (1996)
Client/Server	LADSS: Rural Land-use planning tool	Rivington <i>et al.</i> (2004; 2001)
Client/Server	Supporting land development village planning in Chiangmai, Thailand	Chuenpichai <i>et al.</i> (2002)
Framework	Supporting land-use management in Nantou County, Taiwan	Ho and Lee (2000)

A range of integration types can be categorised as single interface approaches (see Figure 2.7). The merged integration approach combines two approaches, with one acting as the shell around the other. The enhanced integration approach describes methods, which are enhanced with additional capabilities by employing external routines, for example enhancing the GRASS GIS with a neural network routine as achieved by Muttiah *et al.* (1996). The customised integration approach utilises tools, like the Macro language of a system, in order to implement the second system; for example, the AVSWAT model in ArcView (see Table 2.3). The client/server integration approach employs standard communication protocols, such as DDE (Dynamic Data Exchange), to perform communication between two systems. Finally, the framework integration approach is achieved by simultaneously running both systems using a third system. Further information on these approaches can be found in Lilburne (1996).

#### 2.4 Multi-Criteria Decision-Making (MCDM)

In the early days of operations research, real world problems were treated as single criteria. However, the existence of multiple and conflicting criteria that require more sophisticated tools, was quickly realised; hence the development of Multi Criteria Decision-making (MCDM) approaches. MCDM problems can be defined as follows:

*Definition 2.1* In general the MCDM problem works with a set of  $k$  decision variables, a set of  $n$  objective functions and a set of  $m$  constraints. The objective function optimisation reads:

$$\text{Max/Min } f(\vec{x}) = f_1(\vec{x}), f_2(\vec{x}), f_3(\vec{x}), \dots, f_n(\vec{x}) \quad (2.1)$$

$$\text{Subject to } c(\vec{x}) = c_1(\vec{x}), c_2(\vec{x}), c_3(\vec{x}), \dots, c_m(\vec{x})$$

$$\text{Where } \vec{x} = x_1, x_2, x_3, \dots, x_k \in X$$

$$\text{and } f(\vec{x}) \in F(X)$$

where  $X$  is the decision (search) space and  $F(X)$  is the objective space (Figure 2.9)

The main obstacle in multi criteria problems is that there are no absolute optimum solutions for individual criterion (Mateu 2002). Often the decision-maker needs to accumulate solutions located in the feasible region of the objective space based on trade-offs (Figure 2.10), or to combine the potentials of each option to form a group of preferences (i.e. feasible solutions). This means there is no real utopian solution, but a *compromise or satisficing solution* is sought (Hwang *et al.* 1993).

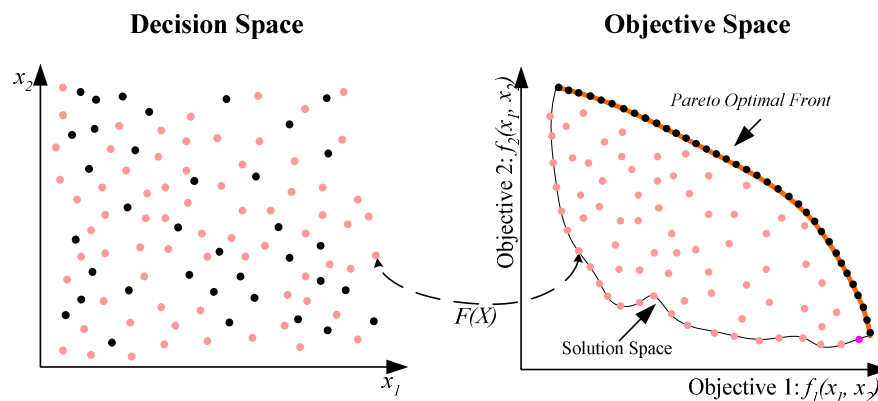

Figure 2.9 Solution search space and objective space for a multiple (2D) objective problem

*Definition 2.2* A compromise solution is a single solution point within the solution space where the difference between the potential optimal point and the utopian solution is at the minimum.

*Definition 2.3* A utopian point (a.k.a. ideal point) is at the optimum point where all objectives are at their optimum (Marler and Arora 2004) (Figure 2.10). The utopian solution is located in the infeasible region, which means it cannot be realised (Matthews 2001).



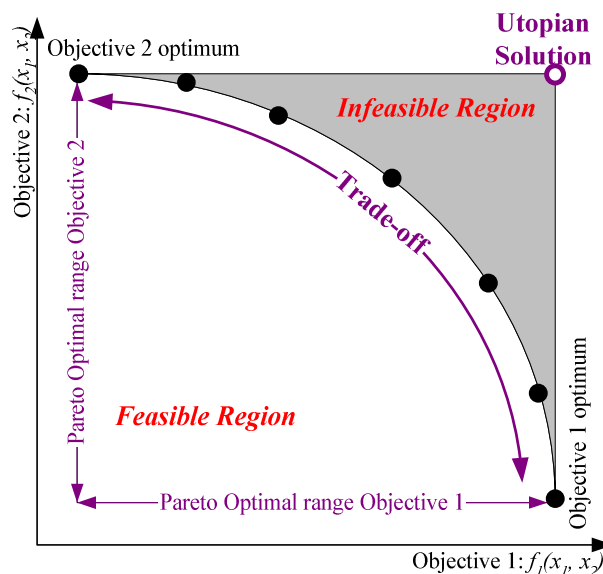

Figure 2.10 Trade-off solutions (Matthews 2001)

In MCDM, a solution is said to be most ideal when based on the preference and the priority value of the decision-maker (Sen 2001). Moreover, a solution does not have to be an optimum, instead it can be a satisficing one.

*Definition 2.4* A solution is referred to as a satisficing solution if and only if the solution satisfies all the aspirations of the decision-maker, while the aspiration level is the acceptable level in the objective space based on the decision-makers importance (Miettinen 2001).

#### 2.4.1 Pareto optimality

A utopian solution is generally almost impossible to obtain. The next best solution is to obtain a *Pareto Optimal* solution. *Pareto Optimality* has been the basis of most cooperative multiple objective optimisations. It is based upon the principle of point dominations, where one point dominates another based on their performance against overall objectives. The *Pareto* optimum concept was introduced by Vilfredo Pareto in 1896 (Coello Coello 1999). The fundamental idea of a *Pareto Optimum* in multiple objective optimisation problems is identifying optimal solutions for overall problem objectives, as the non-dominated solutions. The set of non-dominated solutions forms a *Pareto Front*. The formal definition of a *Pareto Optimal* can be outlined by the following:

*Definition 2.5 Pareto dominates:* If there are two solution sets with  $k$  decision variables  $\bar{y}$  and another solution set  $\bar{z}$ . The  $\bar{y}$  solution is said to have

a Pareto dominance over  $\bar{z}$  if and only if all objective values of  $y$  are better than the objective values of  $z$ .

$$\bar{y} \succ \bar{z}, \text{ iff } f(\bar{y}) > f(\bar{z}) \text{ for all decisions } k \quad (2.2)$$

*Definition 2.6 Pareto weakly dominates:* If there are two solution sets with  $k$  decision variables  $\bar{y}$  and another solution set  $\bar{z}$ . The solution  $\bar{y}$  is said to have a Pareto dominance over  $\bar{z}$  if and only if all objective values of  $y$  are better than or equal to the objective values of  $z$ .

$$\bar{y} \succeq \bar{z}, \text{ iff } f(\bar{y}) \geq f(\bar{z}) \text{ for all decisions } k \quad (2.3)$$

*Definition 2.7 Pareto indifferent:* If there are two solution sets with  $k$  decision variables  $\bar{y}$  and another solution set  $\bar{z}$ . The solution  $\bar{y}$  is said to be Pareto indifferent with respect to  $\bar{z}$  if and only if the objective value of  $y$  is not dominated by the objective value of  $z$ , and vice versa.

$$\bar{y} \succeq \bar{z}, \text{ iff } f(\bar{y}) \not\geq f(\bar{z}) \wedge f(\bar{y}) \not\leq f(\bar{z}) \text{ for all decisions } k \quad (2.4)$$

Based on the example given in Figure 2.11 the Pareto dominance theory can be applied as such: the solutions  $\mathcal{B}$  and  $\mathcal{C}$  dominate  $\mathcal{A}$ , while  $\mathcal{A}$  dominates  $\mathcal{D}$ . Solution  $\mathcal{E}$  is weakly dominated by solution  $\mathcal{A}$ . Both solutions  $\mathcal{G}$  and  $\mathcal{H}$  are indifferent solutions towards  $\mathcal{A}$ .

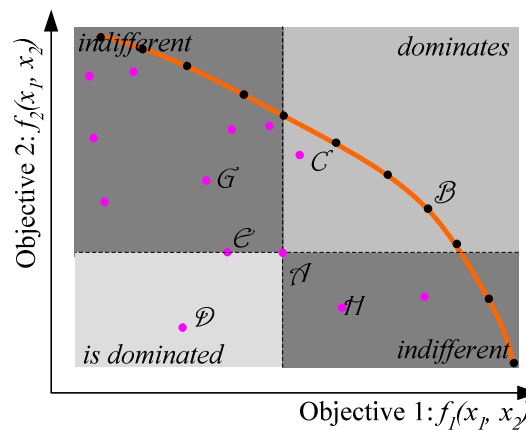

Figure 2.11 An objective space solution of two objectives

Figure 2.11 shows that, since solutions  $\mathcal{B}$  and  $\mathcal{C}$  independently are not dominated by any other solutions, they therefore form a *Pareto Optimal* solution. In this case, none of the objectives of solution  $\mathcal{B}$  can be improved without causing degradation in at least one other objective.

*Definition 2.8 Pareto Optimal:* If there is a solution set with  $k$  decision variables  $\bar{y}$  it is said to be a Pareto Optimal solution if and only if  $y$  is not dominated by any other solutions.

*Definition 2.9 Pareto Front: The image of the whole optimal set in the objective space is called a non-dominated set or Pareto Front.*

At the *Pareto Front*, the decision-maker is required to make a trade-off between objectives to move to a new *Pareto Optimal* point (Figure 2.11).

#### 2.4.2 Multi-Criteria Decision-Making (MCDM)

MCDM approaches have been simply categorised into the Multiple Attribute Decision-making (MADM) (Section 2.5) and the Multiple Objective Decision-making (MODM) approaches (Section 2.6) (Hwang and Yoon 1981) (Figure 2.12).

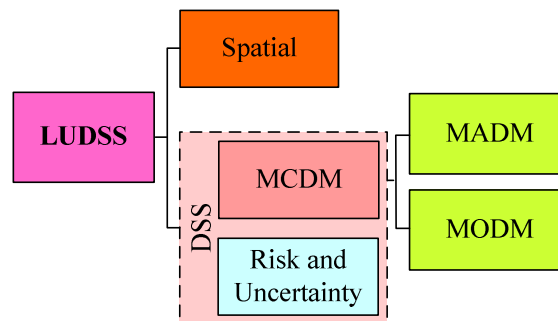

Figure 2.12 LUDSS: Analysing MCDM methods

The MADM and MODM approaches are distinguished by the way their decision spaces are formed and the way a criteria is evaluated into a set of attributes or a set of objectives (Pan 1999) (Figure 2.13). In the MADM approach, the decision space is discrete in which a set of alternatives and a set of attributes have been pre-specified prior to the commencement of the decision-making procedure. From these alternatives, the most preferred solution is chosen based on the preference/priority attributes of the decision-maker.

In the MODM approach, the decision space is usually continuous (a large number of choices) and the alternatives are not pre-determined (Zanakis *et al.* 1998). The aim is to search the large “infinite” decision space to obtain optimum, “most satisficing” solutions. The approach commences with a predetermined set of objective functions (decision criteria) and a set of constraints. Whilst the decision solution space is continuous, it becomes a subset of the continuous space by iteratively employing restrictions or constraints (Figure 2.13).

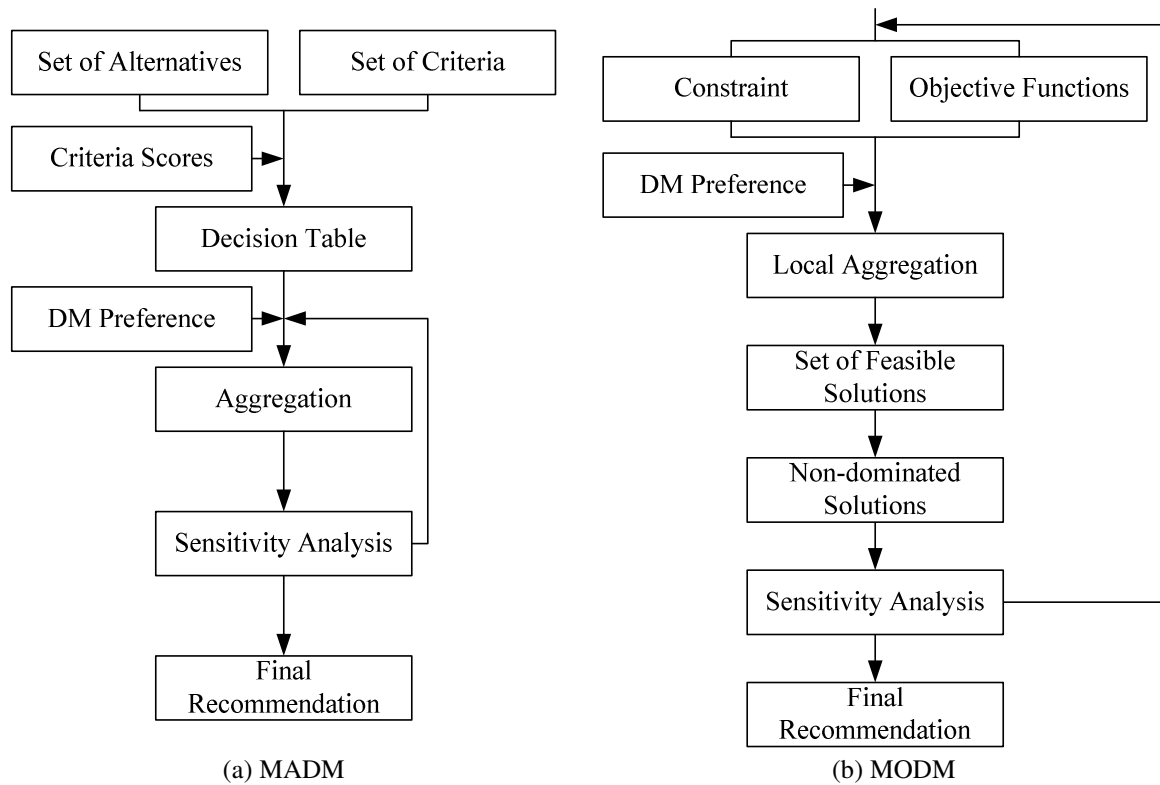

Figure 2.13 General procedure of the two MCDM methods (Chakhar and Martel 2003)

## 2.5 Multiple Attribute Decision-Making (MADM)

Multi-attribute decision-making (MADM) is an approach for making preference decisions by employing procedures, such as exploring, selecting, screening, ranking, prioritising and classifying the available finite set of alternatives against multiple (usually conflicting) attributes. A functional MADM model should be able to exhibit trade-offs between various attributes, being a measure of priority for each alternative based on information given by numerous parties (Pan *et al.* 2000). In this approach, the attribute of the alternative will act as a decision variable, as well as, decision criteria.

Typically, a MADM model development occurs in three stages: structuring, analysis and synthesis. In the structuring stage, a number of elements, such as the decision objectives, measurable attributes and alternatives, will be identified and generated and may be formed into a decision tree. In the analysis stage, the decision-maker's preference will be elicited to determine the trade-offs and risk. This stage is then continued to the synthesising stage where the advantages and disadvantages of the

alternatives are evaluated and compared against each other by using all the information provided.

MADM approaches can be classified into three classes based on how preferences are articulated (Figure 2.14). These are: never articulate preferences, prior articulation of preferences (Aggregation Procedures) and progressive articulation of preferences (Interactive Methods). The Aggregation Procedure is further classified into two classes - Performance Aggregation Oriented and Preference Aggregation Oriented (Figure 2.14) - according to Guitoni and Martle (1998).

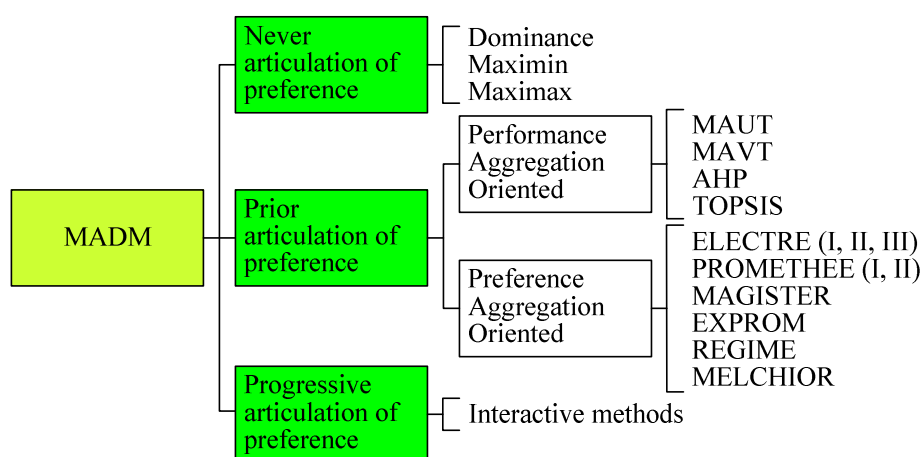

Figure 2.14 MADM methods

### 2.5.1 No articulation of preference

In this category, the MADM methods do not require any preference articulation from the decision-maker. Some of the methods in this category are: *Dominance*, *MaxiMin* and *MiniMax*. The *Dominance* method eliminates an alternative if it is “dominated” (i.e. worse than) by another alternative. The *MaxiMin* method examines the minimum gain associated with every alternative taken and selects the alternative that maximises the minimum gain. The *Maximax* method selects the alternative that maximises the maximum gain for every alternative (Catrinu 2006).

### 2.5.2 Performance aggregation oriented methods

The aim of performance aggregation oriented methods, or so called single synthesising approaches, is to determine an aggregation function that illustrates the decision-maker preferences (Söderberg and Kärman 2003).

The major methods within the performance aggregation oriented approach are: Multi Attribute Utility Theory (MAUT), Multi Attribute Value Theory (MAVT) (Beim and Lévesque 2004; Seppälä 2003) and Analytic Hierarchy Process (AHP) (de Steiguer *et al.* 2003; Saaty 1997).

MAUT/MAVT is a structured quantitative comparison method that determines a simple expression for decision-maker preferences. It utilises utility/value functions to transform different criteria (e.g. cost, benefit, risk and stakeholder acceptance) into one common, dimensionless scale of utility or value; usually between zero and one (Linkov *et al.* 2004). The difference between the two methods is that MAUT focuses on risk and uncertainty, while MAVT makes use of preference scores.

AHP (Paulo 2003) was designed to reflect the way a decision-maker thinks when he/she encounters a complex situation, where decision-makers are inclined to gather the decision preference based on their common features. The three important processes of the AHP are: (1) decomposing the problem into a hierarchy of criteria and alternatives (i.e. elements); (2) comparing pair-wise elements (based on preference, importance or likelihood) to other elements within their level to generate relative ranking of alternatives is generated; and (3) propagating level-specific local priorities to global priorities.

There are also other preference aggregation based methods such as TOPSIS - the Technique for Order Preference by the Similarity to Ideal Solution (Hwang and Yoon 1981). This is a quantitative approach where the best alternative has the shortest Euclidean distance with the fictitious ideal solution but farthest from the negative-ideal solution.

### 2.5.3 Preference aggregation-based

The aim of the preference aggregation-based method, also known as the outranking synthesising approach, is to establish an aggregation of the decision-maker preferences with a comparison of the fit of each alternative with each criterion. The method classifies the alternatives based on the hypothesis that *A is at least as good as B*. Then it investigates the concordance and discordance between them using a decision procedure (Grassini and Viviani 2005).

The most commonly used Preference Aggregation-based methods are ELECTRE (Elimination Et Choix Traduisant la Realite- Elimination and choice Translation Reality) (Benayoun *et al.* 1966) and PROMETHEE (Preference Ranking Organisation Method for Enrichment) (Brans and Vincke 1983). ELECTRE is a multi-objective ranking method based on the outranking relation by using pairwise comparison of alternatives based on different criteria. PROMETHEE is an outranking method utilising a preference function to measure the degree of preference of one alternative to another in respect to each criteria (Parsons 2002).

#### 2.5.4 Interactive methods

Interactive methods allow decision-makers to interact with the computation process from time to time. When a preliminary calculation is made, the decision-maker is able to provide extra information on preferences and a new solution is generated.

Köksalan and Ulu (2003) utilised an interactive approach to handle problems, such as selecting applicants for different kinds of scholarships and selecting projects for different kinds of funding policies. Ben Abdelaziz and Krichen (2005) developed an interactive approach for a bilateral optimal selection problem. In their model, two decision-makers are required to observe a number of sequential offers and select a compromise offer. Kim and Choi (2001) developed an interactive group support system, RINGS, which is an interactive procedure to solve multi-attribute group decision problems by utilising range-typed utility information.

#### 2.5.5 Applications of MADM in natural resources management

MADM has been applied extensively in natural resource management, including land-use planning. Table 2.4 lists a number of different natural resource management initiatives where MADM has been applied. All the MADM methods have been applied extensively in various application areas, ranging from site prioritisation, land-use planning to farm and environmental management.

Table 2.4 Application of MADM methods in natural resource management

Application Area	MADM Methods	Purpose	Citation
Agroforestry planning	AHP	Assessing agroforestry and plantation management in East Usambara Mountains, Tanzania	Huang <i>et al.</i> (2002)
Forest management	ELECTRE	Forest watershed resources management in Arizona	Tecele and Fogel (1987)
	AHP, MAVT, MAUT, ELECTRE, PROMETHEE	Forest management planning in Finland	Kangas <i>et al.</i> (2001a; 2001b); Kangas and Kangas (2005)
Farm management	PROMETHEE	Formulating farm production decisions in Nebraska, USA	Parsons (2002)
	MAVT	Assessing crop ranking for Narmada river basin	Gupta <i>et al.</i> (2000)
	AHP	Assessing criteria and indicators for sustainable forest management in Kalimantan, Indonesia	Mendoza and Prabhu (2000b, a)
Site prioritisation	ELECTRE, AHP	Land-use planning for housing management in Switzerland.	Joerin <i>et al.</i> (2001)
	PROMETHEE	Assessing suitable location for onsite wastewater treatment system in Gold Coast, Australia	Carroll <i>et al.</i> (2004); Khalil <i>et al.</i> (2004)
	AHP	Selecting suitable sites for animal waste in southeast Queensland, Australia	Basnet <i>et al.</i> (2001)
Land-use planning	PROMETHEE AHP	Evaluate optimal land-use in promoting geo-source sustainability in <i>Hanau-Seligenstadt Basin</i> .	Lerch <i>et al.</i> (2003); Hoppe <i>et al.</i> (2005)
	PROMETHEE	Evaluates land-use strategies in Saxony (Germany) - the Torgau district	Klauer <i>et al.</i> (2002; 2000)
	ELECTRE	Land-use planning in Adiyaman Ziyaret Stream Basin	Akpinar (2003)
	AHP	Land-use planning in Cape Region, Mexico to minimise inter-sectoral environmental conflicts	Malczewski <i>et al.</i> (1997)
	ELECTRE, PROMETHEE	Assessing alternative for Environmental decision-making in Finland	Hokkanen and Salminen (1997)
Water management	ELECTRE, PROMETHEE EXPROM	Assessment of alternative irrigation strategies in Spain	Srinivasa Raju and Duckstein (2004);
Environment management	ELECTRE AHP	Management options assessment of the West Coast Trail in Pacific Rim National Park, Canada.	Rudolphi and Haider (2004);
	MAUT	Identify policy alternatives in the management of Spruce budworm in Canadian forest	Levy <i>et al.</i> (2000)
Management selection	ORESTE	Land mine detection strategies assessment	De Leeneer and Pastijn (2002)
Rehabilitation management	TOPSIS and AHP	Defines effective rehabilitation interventions for contaminated sites	Carlson <i>et al.</i> (2004); Critto <i>et al.</i> (2002)
Environmental protection management	MAUT	Prioritising the development of environmental protection actions in the Mediterranean coastal	Angelidis and Kamizoulis (2005)



## 2.6 Multiple Objective Decision-Making (MODM)

MODM and MADM have characteristics common to the majority of MCDM problems: multiple criteria, conflicting criteria, incommensurable components and complications in the design or selection of alternatives (Pan 1999). Nevertheless, that is where the mutual characteristics stop. MODM and MADM vary significantly in their decision solution space. In MODM, the decision solution space is continuous and the alternatives are not pre-specified. This differentiates MODM from MADM, which selects from a set of explicitly defined alternatives based on their attributes.

MODM procedures can be staged into two phases: the first determines the objective function, which incorporates the preferences of the decision-maker and is followed by the selection of a suitable method to optimise the objective function (Figure 2.15).

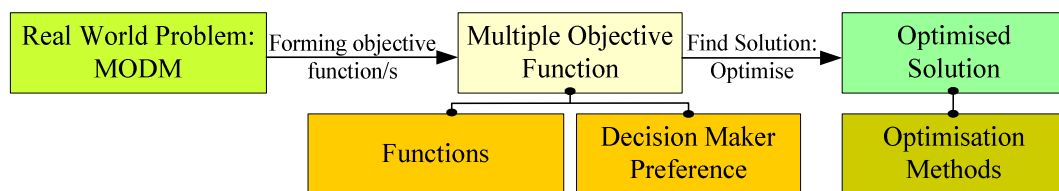

Figure 2.15 Procedure for problem resolution using a MODM method

The main characteristic of the MODM method is that it deals with a multi criteria problem, where the solutions given represent trade-off solutions between competing objective functions. This kind of trade-off solution requires additional information about the decision-makers' preferences (Figure 2.15). These preferences indicate how the decision-maker ranks and weights their objective functions based on the importance of the objective function to the decision-maker. Thus preference articulation is a significant action in forming an effective objective function. Preference articulation methods are concisely described in Section 2.6.1. Once the multiple objective functions have been formed, the next step is to employ a suitable optimisation method to determine optimal solutions (Section 2.6.2).

### 2.6.1 Multiple objectives function: preference articulation

Hwang *et al.* (1980) classify MODM preference articulation approaches into four classes depending on the type of the preference information and the time *when* the

preferences are conveyed by the decision-maker: never, prior to, progressively or after the solution is generated (Figure 2.16).

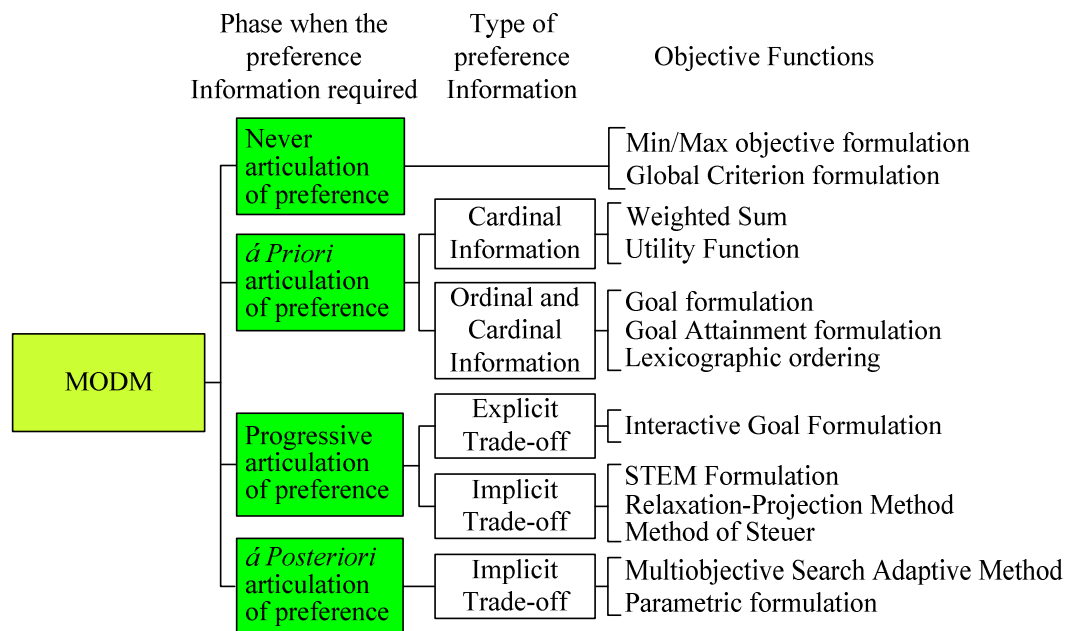

Figure 2.16 MODM methods classification (Hwang *et al.* 1980)

#### 2.6.1.1 No articulation of preference

In some of the decision problems, expert knowledge or a particular preference are too complicated to be articulated by the decision-maker. Under this condition, various objective functions are combined into an overall objective (scalar) function (Andersson 2001). Objective functions formulated for these approaches can be optimised using a single criteria Mathematical Programming method (Section 2.6.2.1) (Hwang *et al.* 1980). Two of the most widely used approaches are global criterion formulation and min-max formulation (Coello Coello 2000a).

#### 2.6.1.2 á Priori articulation of preference

The á Priori articulation approach require the decision-maker to provide the preference information *prior* to the problem being solved. Usually this type of preference articulation approach will solve the decision problem by forming/aggregating a vector of objective functions to a single (or a series of) objective scalar problems. This type of approach is also called the Scalarisation Approach (Marler and Arora 2004).

This articulated preference can either be solely cardinal or mixed with ordinal information. Cardinal preference is usually a specific level or trade-off of the decision-maker's preference for an objective; whereas in a mixture approach, the decision-maker needs to rank the objectives in order of significance (Hwang *et al.* 1980).

One of the most famous approaches within the *á Priori cardinal* approaches is the weighted sum formulation (Zhao 2002). In this approach, the decision-maker is required to choose different weightings as the preference information. The main objective function is a single objective function, which is formed by summing the weighted "sub-functions" (i.e. a number of objective functions) of the problem. A suitable single objective function (e.g. Linear Programming) or search method can then be used to solve the formed objective function and find the optimised solution. This is an *ad-hoc* procedure and it is remarkably sensitive to the setting of the weights (on objectives) (Andersson 2000; Fonseca 1995). The Utility function uses the same approach (Andersson 2000; Hwang *et al.* 1980).

The most common *á Priori mixed (cardinal and ordinal)* approach is Goal formulation, which utilises Goal Programming to solve the problem. Goal Programming is an extension of Mathematical Programming used to handle multiple objective problems. Usual Mathematical Programming models are compatible with objective functions, but Goal Programming (see Section 2.6.2.1) employs *goals* instead of *objectives*. In addition, preferences in Goal Programming can be assigned to each goal in terms of weights and on '*á Priori*' value. For each goal a weight can be assigned in terms of the goal's relative importance. Finally, a set of goals can be organised in groups of different priorities. By having all this preference information, Goal Programming uses Linear Programming or Non-linear Programming methods to achieve each goal target sequentially (Chowdary and Slomp 2002). Other methods that employ the *á prior* explicit preference approach are: Lexicographic ordering (Cvetkovic 2000) and the Goal Attainment method (Hwang *et al.* 1980).

### 2.6.1.3 *Progressive* articulation of preferences

*Progressive, interactive approaches*, assume that the decision-maker is unable to define the exact preference prior to running the solving routine due to the

complicated nature of the decision problem. As the decision-makers understanding deepens, flexibility of the routine allows for changes to be made to preferences, which in turn progressively reduces the search space (Andersson 2001).

There are two types of preference information: implicit trade-off and explicit trade-off information. Approaches with explicit trade-off information require preferred trade-offs associated with an achievement level of an objective. To incorporate this type of approach, Goal Programming is extended to incorporate the explicit trade-off. In the *Interactive Goal Programming* method, the decision-maker takes the role of the expert who sets the target levels for every objective and based on these, a solution is then generated. Unlike Goal Programming, the process continues by asking the decision-maker to reconsider the decision on the target levels and another set of solutions is generated. This procedure continues until the decision-maker approves the final solution (Reeves and Hedin 1993).

The implicit trade-off approaches assume the decision-maker is able to specify adequacy of the current attainment level (Hwang and Yoon 1981). The Step Method (STEM) (Benayoun *et al.* 1971) is the most commonly used method utilising this type of approach. In this method the decision-maker is trained to recognise good solutions and the relative importance of the objectives by adding constraints to the criteria value. The procedure is carried out iteratively until the decision-maker is satisfied with the solution (Baesler and Sepúlveda 2001). At each iteration the decision-maker is provided with a feasible and acceptable level of solutions. If the decision-maker is satisfied with these solutions then the process is completed. If not, the least satisfactory performance objective function will be redefined by loosening the criteria and a new solution is generated (Vincke 1992).

#### 2.6.1.4 *á Posteriori* articulation of preferences

The *á Posteriori* approaches, named *Pareto* approaches, maintain the disconnection between the objective function right through the optimisation process (de Weck 2004). The procedure usually starts by exploring and generating a set of all feasible solutions before the decision-maker can make the preferred selection (Laumanns 2003). The optimisation procedure has two stages: 'Search' and 'Select' (Section 2.6.2.2). The 'search' stage uses a search method (Section 2.6.2.2.1) or a

Mathematical Programming approach to identify a set of solutions while a trade-off method (Section 2.6.2.2.2) is used to incorporate the decision-maker(s) preference to find the best trade-off solution.

## 2.6.2 Optimisation methods

After the objective function is formed and the decision-maker's preferences are articulated, the next significant decision is to decide on the type of optimisation method to be used. There are two major techniques that can be utilised to optimise multiple objective problems. These techniques can be categorised into two broad classes (Mayer *et al.* 1998a) (Figure 2.17): direct optimisation and search techniques.

The most commonly used direct optimisation techniques are Mathematical Programming methods (Section 2.6.2.1). The search technique has been split into two approaches - those using search methods or those using ranking and trade-off analysis to determine the solution (Figure 2.17).

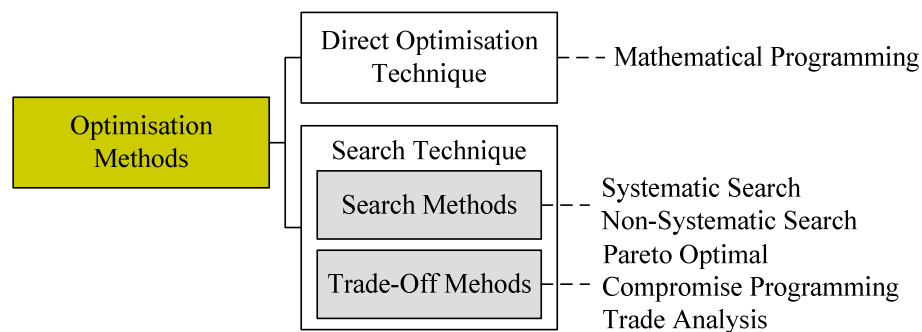

Figure 2.17 Techniques to optimise multiple objective problems

### 2.6.2.1 Direct optimisation technique: Mathematical Programming

A large number of Mathematical Programming techniques have been developed, including Linear Programming (LP), Quadratic Programming (QP) and Goal Programming (GP). These approaches have been developed to solve different cases of problems including those in the natural resources industry (Simons 1995) and farm management (Pannell *et al.* 2000).

In general, LP and QP are single objective optimisation methods. However, these methods have been employed to tackle multiple objective problems, which merge multiple objectives into a “single objective” (Figure 2.18). Linear Programming is

the simplest Mathematical Programming model, being the most widely used optimisation technique in land-use decision-making (Briassoulis 2000). The main purpose of a LP model is to optimise an objective function subject to a set of constraints, where both the objective function and the constraints are linear equations (Chuvieco 1993). Quadratic Programming is a generalisation of Linear Programming, which still employs the linear functions constraint, but the objective function is structured to allow the incorporation of quadratic expressions (Vanderbei 2001).

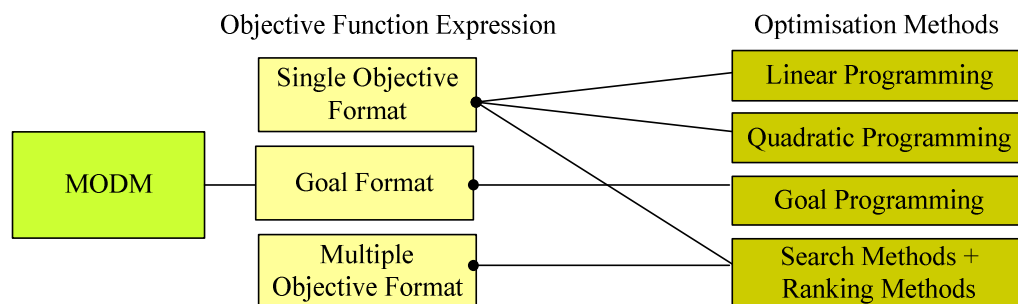

Figure 2.18 Relationship between MODM objective functions type and optimisation methods

Goal Programming (GP) is an extension of Linear Programming and is designed to work with multi-objective problems (Hillier and Lieberman 2001; Ignizio 1985). It allows the decision-maker to assign preference to objective functions according to relative importance or achievement levels of the goals (Mansouri *et al.* 2000). Hayashi (2000) states that GP has been the method that is most used in farm and regional planning. It has been found useful because the objective function can comprise homogeneous and/or non-homogeneous measurement units (Ignizio and Cavalier 1994).

In addition, in MP it is crucial to perform post-optimisation analyses. Two of such post-optimal analyses are: sensitivity analysis and parametric programming. Both methods study the effect of changes in the variable of a model or the constraint to the problem. While sensitivity analysis studies the effect of discrete changes, parametric programming studies continuous changes. Both methods are not trying to define the optimal solution to a function, but are trying to find out how a function behaves as changes are made to the coefficients of the problem function. Further information on

these approaches can be found in Sinha (2006), Saltelli *et al.* (2000) and Pannell (1997).

Although Mathematical Programming is a powerful method, it has a major disadvantage. It is a highly restrictive method, as it is only able to find the best solution to the problem based on how it is modelled. Therefore, the success of the solution depends solely on how well the model represents the actual problem.

#### 2.6.2.2 Search techniques

As noted in Section 2.6.2, there are two major search techniques to determine the optimal solution to a formulated problem: search and trade-off methods. These are described hereafter.

##### 2.6.2.2.1 Search methods

A search model is formally defined as an algorithm used to explore a problem solution space with the objective of locating a particular solution (CIRL 2003) and theoretically, a search method, efficient or not, should be able to find the solution required for every decision problem. These algorithms can be categorised into two broad classes (Blum and Roli 2003): systematic and non-systematic search methods.

A systematic search algorithm explores the complete problem space and will achieve a solution to the problem if a solution is available. However, if a problem lacks a solution, these methods are able to recognise the problem without a doubt (CIRL 2003). The simplest systematic search method is the *Exhaustive Search* method, where all possible solutions are determined and a decision-maker is able to observe all possible solutions and then categorise and rank these to identify the “best” solution.

The non-systematic search methods do not explore the problem space completely and therefore, unlike the complete search algorithm, they are not able to provide evidence that a solution does not exist (CIRL 2003). These methods tend to be called meta-heuristics methods. The most common meta-heuristics methods are *Simulated Annealing* (Kirkpatrick *et al.* 1983), *Tabu Search* (Glover 1990, 1989) and *Genetic*

*Algorithm* (Goldberg 1989). A comprehensive review on different meta-heuristics methods and their attributes can be found in Blum and Roli (2003).

Simulated Annealing (SA) is an analogy of the way the annealing process progression is used to toughen material by heating and controlled cooling. The SA algorithm, a generalisation of the Monte Carlo method, was first introduced by Metropolis *et al.* (1953) and was presented as an optimisation method by Kirkpatrick *et al.* (1983). The main idea of SA is to escape from the local optima by leaping out to another region to obtain better optimisations. It iteratively moves from one solution to another using a (decision) probability value. The probability is selected to ensure that the search tends to move to a preferred state. The iteration will stop when it reaches an acceptable state or until a given threshold is achieved.

Tabu Search (TS) is an “intelligent” problem solver and was first proposed by Glover (1990). It was inspired by human behaviour, which to a large extent acts by taking strategic choices (responsive exploration) based on the memories of past experience (adaptive memory) to improve current decision-making. Tabu Search iteratively moves from one solution to another until some stopping criterion has been satisfied. The recent past experience (solution) is stored into a list, called a *tabu list*, along the way. As such, it avoids moving in circles by forbidding or penalising a move from one solution to another, if the next solution has been visited recently.

Genetic Algorithms (GA) are general-purpose search algorithms, which mimic the nature of evolution. They were first developed by Holland *et al.* (1986) in the 1960s. GA employs evolution operators to determine the optimal solution to a problem. The search will only cease when a termination condition is encountered (NeuroDimension 2002). GA is different from the other non-systematic search methods like TS and SA. TS and SA are based on a point search principle, with the aim to improve that point. However, GA is based on a *population of chromosomes*, which act as the *population of candidate* solutions. It tries to improve the solution by using different combinatory methods to find the next set of solutions. Further detail will be discussed in Chapter 3.



#### 2.6.2.2.2 Ranking trade-off method

It is well known that in multiple objective problems the preference of the decision-maker plays a significant role in determining the “best” solution. When the decision-maker articulates preferences prior to the procedure, the result of the search will generate a single objective value. Thus the *Pareto Optimal* ranking can be easily performed. However, when the result of the search generates multiple objective values, then higher-level decision-making techniques are required to select a solution. Techniques classified as ranking methods include Compromise Programming and marginal rate of return (Deb 1999).

Compromise Programming (Yu 1973; Zeleny 1973) is a distance based multi-criteria analytical method (Abrishamchi *et al.* 2005). The fundamental idea behind this approach is the existence of a *utopia point*; the best solution is defined as that which is the closest (linear/weighted) to the ideal or utopia point. Further reading can be found in Zeleny (1982, 1976), White (1984) and Yu (1985).

The marginal rate of return indicates the amount of improvement of one objective function by decreasing the performance of any other objective function by one unit. (Deb 1999). In this method, the solution with the highest marginal rate of return is chosen as the best solution.

Moreover, Data Envelope Analysis (DEA) has also been used as a ranking method. DEA is a methodology that analyses the relative efficiency of a number of decision-making units or alternatives. The efficiency of an alternative is determined based on the non-dominance concept, where an alternative is said to be efficient when the outputs cannot be increased without increasing some of its inputs, or decreasing some of its outputs (Chauncey *et al.* 1985).

#### 2.6.3 The relationship between optimisation methods and objective functions

Most of the time, the selection of a suitable optimisation method depends on the format of the objective function. However, there is no strict relationship between the format and the employment of the methodology, and the choice of format and method depends on the problem at hand.

Multiple objective problems that are scalarised into a single objective function form can be resolved with a single objective optimisation method, such as Linear Programming, Quadratic Programming or search techniques (Figure 2.18). However, true multiple objective problems usually work with search methods to find possible solutions while employing trade-off ranking methods to facilitate the choice of the best possible solution.

#### 2.6.4 Applications of MODM in natural resources management

MODM is popular in the planning and management of natural resources, such as land-use.

Table 2.5 lists a number of different natural resource management applications where MODM models are used. Mathematical Programming has been extensively used in land-use planning; however, heuristic methods have become more popular in recent years.

Table 2.5 Applications of MODM methods in natural resources management

Application Area	MODM Methods	Purpose	Citation
Site/Water management	Genetic Algorithm	Determining optimal location of pumping wells	Vemuri and Cedeño (1996)
Land-use planning	<i>Pareto Optimal</i> Genetic Algorithm	Strategic land-use planning	Matthews <i>et al</i> (2004)
	Linear Programming	MIDAS: whole-farm land-use planning management in Australia	Kingwell and Pannell (1987);
Land development management	Fuzzy Goal Programming	Evaluating sustainable management strategies for optimal land development in Taiwan	Chang <i>et al.</i> (1997)
Farm management	Compromise Prog. MiniMax	Assessing dairy farm management in USA	Tozer and Stokes (2001)
	Fuzzy Linear Programming	Farm planning in Narmada River basin	Gupta <i>et al.</i> (2000)
	Hill Climbing Direct Search Genetic Algorithm Simulated Annealing	Optimising dairy farm model with 16 separate, interactive managerial options	Mayer <i>et al.</i> (1999)
	Goal Programming	Determining the best combination of treatment schedules for forest management	Kangas and Pukkala (1992);
Forest management	Weighted Sum Stochastic Optimisation	Optimising stand management for Scots Pine and Norway Spruce	Pukkala and Miina (1997)
	Pareto Theory Genetic Algorithm	Forest management planning tool in Belgium	Ducheyne (2003)
	Weighted Sum Tabu Search	Determining optimum forest harvesting schedules in Tangier watershed, Canada	Brumelle <i>et al.</i> (1998)
	Weighted Sum Genetic Algorithm Simulated Annealing Tabu Search	Assessing forest harvest scheduling problem in Portugal	Falcão and Borges (2002, 2001)
	Interactive Goal Programming	Ponderosa pine forest resource management in Beaver Creek Watershed, Arizona	Teclé <i>et al.</i> (1994)
	Goal Summed Tabu Search + Genetic Algorithm	Assessing forest planning options which optimise timber production and maintain wildlife habitats in Oregon	Boston and Bettinger (2001)
	Weighted Sum Simulated Annealing Genetic Algorithm	Forest management in selection of reserve area problem in Lithuania	Strange (Study V) (2000)
	Weighted Sum Tabu Search	Examining several alternative operational analyses of the accommodation and emulation of fire	Thompson <i>et al.</i> (1998)
	Weighted Sum Simulated Annealing	Long range forest planning model in Sweden	Ohman and Eriksson (2002, 1998)
	Agroforestry management	Goal Programming	Multilevel farm land-use planning for low resource farmers in Ghana

## 2.7 Theories and Concepts for Dealing with Uncertainty

When making a decision, a decision-maker needs to be aware that risk is almost always unavoidable. In almost every application there will be “unreliable”

(imperfect) information incorporated within the decision-making process, possibly causing the selection of a non-optimal solution (Spradlin 1997; Bell 1985). In the absence of total certainty, there is an element of risk associated with a decision's outcome. Hence, risk analysis is needed to avoid making an ineffective decision (Leach 2005; Lieberman 2005).

Risk is the effect of the imperfect information used at a specific time. Imperfect information can be caused by uncertain elements within the dynamic environment of the world, or it may exist because of the imprecise information that is used at the time of decision-making.

*Imprecise* information covers a situation where the value of a variable is given without the precision required; whereas the *uncertainty* covers the situation where a decision-maker has complete information, but is uncertain because it might be wrong (Smets 1991). Therefore, *imprecision* is basically a property of the information itself while the *uncertainty* is the relationship between the information and the decision-maker about a situation (Smets 1997).

Imprecision can take two forms: with or without error. The former relates to approximate and ambiguous information, while the latter refers to inaccurate information (Smets 1997). In a land management context, most of the imprecision originates from data quality, such as data availability and data accuracy, due to aggregation (Just *et al.* 2003; Just 2003).

For decades scientists have been dealing with uncertainties. Numerous theories have been developed to quantify uncertainty, some of the most prominent theories being: Probability theory, Bayesian Probability theory, Evidence theory, Fuzzy set theory and Possibility theory.

The first and foremost conventional approach for dealing with uncertainty is Probability (frequentist) theory (Winkler 1996). In this theory, a probability value is an objective quantitative assessment value that indicates the likelihood that an incident will occur. Conventionally this type of value is expressed on a scale from zero to one. A rare incident will have a probability value close to zero, while a very

likely event will be close to one. The summation of probabilities of all possible disjointed events will be equal to one.

In the Expected Utility theory (von Neumann and Morgenstern 1953), a utility value indicates how desirable each event is. The fundamental idea is that the utility of an element under uncertainty is expressed as the utility of all possible situation which are aggregated into a weighted average where the weighted value is the probability value that the particular situation takes place (Rabin 2000).

With the Bayesian Probability theory approach, beliefs are updated in light of newly obtained evidence (Malczewski 1999). It is therefore a formalism for ‘reasoning’ under uncertainty conditions (Pearl 1990). The methods require two types of information, namely: prior probability and conditional probability. The prior probability describes the probability of an event computed before gaining new evidence. The conditional probability is the probability of an event occurring given the occurrence of another event.

Evidence theory (a.k.a. Dempster-Shafer Evidence theory) was developed by Dempster (1967a) and extended by Shafer (1976b). This theory employs a very different kind of probability value, degrees of *Belief*, which is considered a subjective probability. Degrees of Belief indicate the degree of support by which a particular source of evidence provides for a specific proposition (Shafer 1976a). The basic principle of the Evidence theory is similar to Probability theory. In evidence theory, the degree of belief of a particular event is expressed by a value between zero and one, and the summation of all possible events does not necessarily add up to one. Further reading can be found in Shafer (1992) and Dempster (1968; 1967b).

Fuzzy set theory (Zadeh 1965a, b) is generally used in the presence of information imprecision and subjective information. Zadeh (1965b) proposes a mathematical tool, which describes the way in which common people reason about a system with non-specific or ‘fuzzy’ information. He stated that often in the real physical world the objective classes do not have precisely defined criteria but are a continuum of grades of membership (Metternicht 1999).

Possibility theory (Zadeh 1978) is also a new form of mathematical theory, which works with particular types of uncertainty information. Unlike Probability theory, which employs a single number, Possibility theory tries to describe how likely an event is to occur by employing two numbers - the possibility of the event and the necessity of the event (Dubois and Prade 1992). Possibility has been developed into two main directions: qualitative and quantitative. Qualitative Possibility theory employs ordinal settings, while quantitative Possibility theory uses a numerical scale. Possibility theory has been claimed as an uncertainty theory used for handling incomplete information in a more simplified manner (Dubois and Prade 2003). Therefore, whilst probability primarily deals with the variability in the data, possibility deals with the possibility that a value is inaccurate or incomplete (Chen 2000).

### 2.7.1 Incorporating uncertainty and accounting for risk

Numerous risk modelling approaches have been developed to incorporate risk and uncertainty into a decision-making model. The methods can be grouped into four main types (Figure 2.19): Expected Utility based-approaches, knowledge-based approaches, simulation approaches and Mathematical Programming approaches.

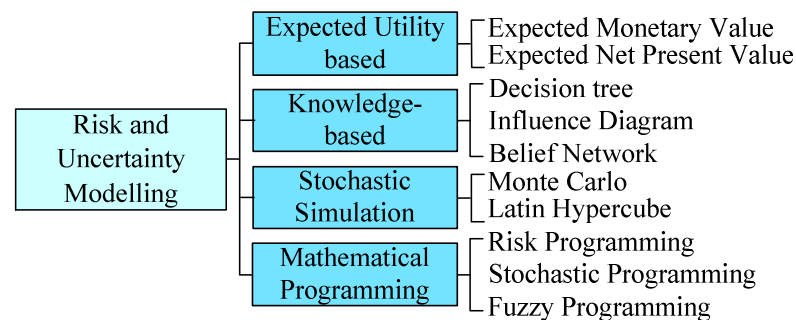

Figure 2.19 Risk and uncertainty modelling approaches and methods

### 2.7.2 Expected utility based approach

The Expected Utility based approaches employ the fundamental idea of Expected Utility theory, where the expected value of an event is summarised into a weighted sum of all possible circumstances that may take place.

The Subjective Expected Utility (SEU) (Savage 1954) approach is a combination between two distinct subjective concepts: subjective opinion about the utility of a

possible outcome (i.e. a strand in Expected Utility theory) and the subjective beliefs about the probability of the outcomes (i.e. based on Bayesian Probability theory). Nau (2006) and Luce (1992) provide a good description and discussion of Subjective Expected Utility.

Another strand of the Expected Utility based approach is the Expected Net Present Value (ENPV) approach, which is an enhancement of the net present value approach. The net present value estimates the discounted value or benefit over a lifetime of a particular project. The expected net present value is the sum of all the weighted (i.e. probability) possible net present values (Treasury Board of Canada Secretariat 1998).

### 2.7.3 Knowledge-based approach

The knowledge-based approaches are based on the fundamentals of the Bayesian theory, where prior knowledge is used to support and increase the confidence towards a possible event; hence reducing uncertainty (O'Brien 2004). Prior knowledge can be in the form of objective information, such as past data. When appropriate, expert knowledge (e.g. subjective knowledge) is applied to provide support, based on the expertise of the experts. Yet it needs to be acknowledged that decisions taken by one expert are unlikely to be similar to the decisions taken by another expert, and may even change over time (O'Brien 2004).

Some of the simplest methods that use the Bayesian knowledge-based approach are (Varis 1997): Decision Trees, Belief Networks and Influence Diagrams (Figure 2.19). The basis of a Decision Tree is to have each decision or chance event set up in procedural order. Each set of results from a node will constitute a decision alternative, forming a new branch in the tree (Varis 1997). Influence Diagrams are an extension of the Decision Tree. They are acyclic Bayesian networks of nodes connected with one another via one-directional links. The nodes act as the probabilistic variables, deterministic variables, and decisions (Varis 1997). Further reading on influence diagrams can be found in Karni (2005) and Oliver (1990).

### 2.7.4 Simulation approaches

Stochastic Simulation is used to act as an analytical approach to study the properties of a real system, investigating all possible system outcomes as functions of the input

(Hardaker *et al.* 1997). The input value is selected in a stochastic (random) manner. The random value (or rather pseudo-random value since the computer is a deterministic machine) is chosen within a set range of values that correspond to a probability distribution that can take a normal, exponential, or any other form. Thus, an environment to illustrate all possible options and results that may take place through a real-life situation is generated.

One of the significant elements in the stochastic simulation is the sampling method, with some of the best known being (Figure 2.19): Monte Carlo sampling, Latin Hypercube sampling and Descriptive sampling. Monte Carlo sampling is a traditional sampling technique using a random number selected within a given range of the input distribution (Baker 1997). The Latin Hypercube sampling (McKay *et al.* 1979), or so called “sampling without replacement”, is a modified type of Monte Carlo sampling where the sampled distribution is stratified into equal intervals, and a value is randomly selected from within each stratum for each basic event. Descriptive sampling (Saliby 1990) is another modified version of Monte Carlo sampling, and is similar to Latin Hypercube sampling. The main difference between them resides in the way random values are selected inside each of the strata (Saliby 1997). Further reading can be found in Saliby (2002) and Palisade Corporation (2000).

#### 2.7.5 Mathematical Programming

Risk and uncertainty analysis can be accommodated within Mathematical Programming (MP) models (Section 2.6.2.1). When risk and uncertainty are accommodated within an MP model, three cases can be distinguished (Sahinidis 2004; McConnell and Dillon 1997) (Figure 2.19): Risk Programming (embedded risk MP), Stochastic Programming (non-embedded risk MP) and Fuzzy Programming.

The main difference between Stochastic Programming and Risk Programming is that the former incorporates risk in the input-output coefficients and resource constraints, while the later tends to restrict risk in the objective function of the model (Hardaker *et al.* 1991).

Quadratic Risk Programming (QRP), using mean-variance analysis as a conceptual framework, is a common Risk Programming model (Vere *et al.* 1997). The mean-



variance (E-V) analysis criterion is based on the Expected Utility theory (Young 1984), where the variance of an expected value constitutes the risk level of the expected value. The approach to reduce risk relies on minimising the variance (or standard deviation) of the expected value (Ogryczak and Ruszczyński 1997). MOTAD (Minimisation of Total Absolute Deviations) (Hazell 1971) and Target MOTAD (Tauer 1983) are modelled using LP to approximate E-V Risk Programming (Vere *et al.* 1997).

Some of the most frequently used Stochastic Programming methods are: Discrete Stochastic Programming (DSP) (Rae 1971; Cocks 1968) and Stochastic Dynamic Programming (SDP) (Bellman 1957).

Discrete Stochastic Programming, sometimes called Stochastic Programming with Recourse (SPR), allows the risk element to be integrated in a constraint set, and the objective function be formulated in a discrete probability distribution manner. A DSP model is capable of handling a large number of decision problems at each stage. At each stage of the model, the possible outcomes are deduced and represented by few representative cases (Torkamani 2005). However, due to its nature, it is only suitable for two-stage decision problems. Strategic decisions are applied in the first stage, and once the random events occur, the second stage takes place; where tactical adjustment is undertaken at a certain cost (Ekman 2002; Fonseca and Flichman 2002). The Model of an Uncertain Dryland Agricultural System (MUDAS) is one example of a DSP model developed to describe the typical farm management found in the eastern Western Australian Wheatbelt (Kingwell *et al.* 1993).

Unlike DSP, Stochastic Dynamic Programming is capable of handling an infinite number of stages (Ekman 2002). However, the nature of the model is such that the problem is divided into a number of one-stage problems, which limits the number of state and decision variables (Fonseca and Flichman 2002). Hence, possible solutions and decision variables tend to be fixed into finite discrete values, with the solution being an approximation. In the case of nonlinear functions, this can cause a considerable amount of error (Fonseca and Flichman 2002).

Finally, Fuzzy Programming sits in a dimension different to risk and Stochastic Programming. In Risk and Stochastic Programming, uncertainty is formed as a discrete or continuous probability function; while in Fuzzy Programming, the random parameters are produced as fuzzy numbers, and the constraints are formed as a fuzzy set (Sahinidis 2004). Some of the most used Fuzzy Programming approaches are: Flexible Programming and Possibilistic Programming (Sahinidis 2004).

#### 2.7.6 Applications of risk and uncertainty models in natural resource management

MODM is popular in the planning and management of natural resources, including land-use.

Table 2.6 lists a number of different natural resource management applications where MODM takes a major role in their management and planning. The table shows no definite trend in the adoption of techniques for dealing with uncertainty in farm management.

Table 2.6 Applications of uncertainty methods in natural resources management

Application Area	Uncertainty Methods	Purpose	Citation
Land-use planning	Monte Carlo	To incorporate uncertainty in the model response of predicting land-use change effects	Eckhardt <i>et al.</i> (2003)
	Influence Diagram	Sustainable land-use planning with uncertain variable	Swayne and Shi (2004)
Land-use planning/ management	Bayesian approach	To evaluate uncertainty about whether the state of landscape is sustainable	Prato (2000)
	Fuzzy set theory	To represent uncertain boundary definitions in geographic data	Weerakoon (2002)
	Fuzzy set theory	To incorporate uncertainty in the interpretation of quantitative information on land-use.	Kurtener and Badenko (2000)
Crop production	MOTAD	To analyse the role of risk in the cropping systems under rain-fed agriculture in Côte d'Ivoire	Adesina and Ouattara (2000)
	Target MOTAD	To incorporate risks in the crop production due to the nature of rainfall in Gwembe Valley, Zambia	Maleka (1993).
Farm management	Fuzzy set theory	To incorporate uncertainty and imprecision associated with the data for crop management	Jones and Barnes (2000)
	Decision Tree	To estimate the risk contamination of soils and water to hydrological modification in agricultural lands of the Sevilla province, Spain.	De la Rosa and Cromptvoets (1998)
	Target MOTAD	To identify optimal management strategies and associated risk level for aquaculture in Honduras.	Valderrama and Engle (2000)
	Monte Carlo	To account for stochastic factors of the environment in a farm management model on a farm in the Canterbury Plains, New Zealand	Cacho <i>et al.</i> (1999)
	Stochastic Programming	To incorporate production strategies due to the rainfall uncertainty into a typical farmer's strategies in Burkina Faso, West Africa	Maatman <i>et al.</i> (2002)
	Risk Programming	To examine the variable rate planting data for profitability and risk reduction.	Dillon <i>et al.</i> (2001)
	Stochastic Programming	To study the impact of risk on farm management practices in northern Syria	Pannell and Nordblom (1998)
	Discrete Stochastic Programming	To estimate the water quality goals and risk in examining economical efficient means of pollution reduction in production practices alternative in Cottonwood River Watershed.	Apland <i>et al.</i> (2004)
	MUDAS	To incorporate climatic, agronomic and economic information to investigate the uncertainty impact on the value of new legumes and their place in the Mediterranean region of WA.	Schilizzi and Kingwell (1999)
	Chance Constrained Programming	To assist Queensland Barley growers in making varietal and agronomic decisions in response to changing product demands and volatile production conditions.	Gali and Brown (2000)
	Stochastic Dynamic Programming	To find optimal harvesting effort and economic return for a realistic set of bio-economic data for Pacific halibut based on price uncertainty	Hanson and Ryan (1998)
	Chance Constrained Programming	To take into account the random nature of soil loss under alternative land-use practices	Zhu <i>et al.</i> (1994)
Forest management	Dempster-Shafer theory	To incorporate the uncertainty and imperfect data in forestry	Ducey (2001)
	Fuzzy set theory	To evaluate sustainability under an uncertain and imperfect environment	Ducey and Larson (1999)
	Fuzzy set theory	Uncertainty and imprecision within a forest planning modelling	Anderle et al (1994)

## 2.8 Assessing the Methods and Techniques Suitable to the Proposed LUDSS

In undertaking this research, there are a number of factors that need to be considered, namely:

1. the decision criteria and optimisation method, which optimise the MCDM problem (Section 2.4 - Section 2.6);
2. methods that incorporate risk and uncertainty factors within the decision support system (Section 2.7); and
3. the approach to spatially present the data and solutions (Section 2.3).

Based on the above list, it is logical to now conduct an assessment of most suitable methods to solve the multiple criteria Land-use Planning problem for a cropping enterprise.

### 2.8.1 Assessment multi-criteria functions and optimisation methods

This research intends to develop a decision support system to help users identify farm management options that incorporate trade-offs between competing objectives and resources. This type of decision-making problem is a multi-objective decision-making problem focused on two key objectives - profitability of the business and its environmental impact.

The aim of the MODM approach is to explore the large infinite decision space, which is a continuous solution space, in order to find the optimum, or “most satisficing”, solutions. The subject of this research thesis “Determining the most feasible option of land-use management with a trade-off between the objectives of maximising profit while minimising environment effect”, is essentially an optimisation problem. This requires finding a *Pareto* optimum value from within a continuous solution space, given the absence of alternatives provided by the decision-maker. Thus, the problem at hand is of a multi-objective nature (Figure 2.20).

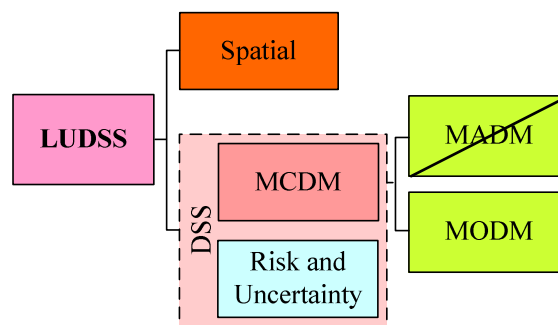

Figure 2.20 MODM problem

Wierzbicki and Makowski (1992) mention that the crucial issue in a multiple objective optimisation problem is to hunt for ideal solutions, which somehow reflect the decision-maker preferences, not just any other random solution. Generally, an ideal solution varies amongst users. Every decision-maker has preferences about which objective has the higher significance. Thus, a decision-maker's preference is a significant element in the search for an ideal solution. In this research, the *Never articulate* approach is inappropriate because the decision-maker's preferences are never considered.

Wierzbicki and Makowski (1992) also suggest that some of the methods are not suitable because the preference applied to the problem creates more discrepancies than solutions. For instance, *á Priori* articulate methods (the *scalarisation approach*), like the weighted sum method, do not allow the user to control the selection of an optimal solution. On the other hand, Goal Programming can be misleading - giving a dominated result when the set of attainable objective outcomes is convex or non-convex. Further discussion on the drawbacks of this approach are detailed in Andersson (2001) and Das and Dennis (1998).

The *Progressive* articulated approach is an interactive method that gives the decision-makers a chance to have a deeper understanding about the procedure prior to introducing a preference value. It avoids the complex problem of articulating 'global' inter-criteria preference information (Bana E Costa *et al.* 1997). However, it has been argued that this type of method is less applicable since it is limited to problems that only involve the choice of a single course of action (Bana E Costa *et al.* 1997). Furthermore, since *Progressive* method is done in an iterative mode, case

studies utilising this method require a considerable amount of calculation (Wright and Loosemore 2001).

The *á Posteriori* approach is accomplished by predefining a set of solutions based on a suitable search method, and subsequently optimising the solutions by using an appropriate trade-off method. In such a case, the decision-makers have the freedom to assert their preference where and when they decide.

From all preference articulation approaches discussed above, the *Never* articulate was eliminated due to its inability to incorporate crucial preference information of the decision-maker. The *á Priori* articulation was discounted due to its simplification of the multiple criteria problems into a scalar vector, making the method unable to protect the dynamic judgemental environment of the decision-maker's preference. Furthermore, at certain times it is difficult for the decision-maker to assert their preference prior to the commencement of the procedure. On the other hand, the *Progressive* method has the ability to incorporate the preference of the decision-maker dynamically. However, this approach is not appropriate due to its iterative nature. Consequently, it was determined that the *á Posteriori* articulation method, which engages in searching of all possible methods, as well as, integrating the dynamics of the decision-maker preference, is thought to provide the best option for the problem at hand (Figure 2.21).

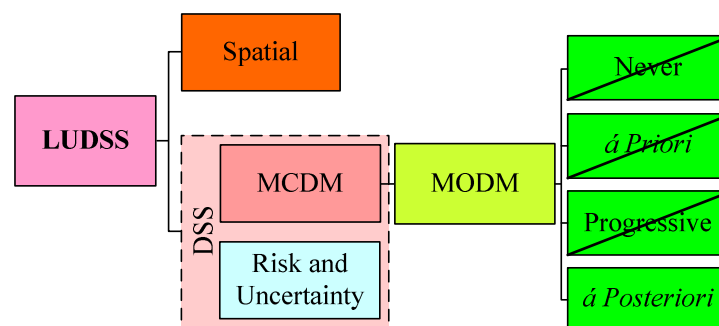

Figure 2.21 Selection of the *á Posteriori* articulate method

As mentioned in section 2.6.1.4, the *á Posteriori* approach has two stages: Search and Select. The search stage uses a systematic search approach (i.e. *Exhaustive Search* method) or an approximate search approach (i.e. *Genetic Algorithm*, *Tabu Search* and *Simulated Annealing*).

Both search algorithm approaches (systematic and approximate) have the ability to easily search solutions across multimodal, discontinued and non-linear decision problems. The systematic approach (i.e. *Exhaustive Search* method) uses the concept where there is no stone left unturned. In most of the cases, due to the nature of the search, it consumes a massive amount of computer memory space and time, thus this method is not considered to be a “smart” method. For this reason several researchers suggest that approximate methods, such as Simulated Annealing (SA), Tabu Search (TS), Genetic Algorithm (GA) and others, are more appropriate to search optimum solutions (Holsheimer and Siebes 1994)

On the other hand, Nievergelt (1995) argues that effectiveness of other search procedures depend on the problems being addressed. Nievergelt (2000) also states that with advances in computer technology exhaustive search is gaining more favour due to its ability to find all the possible solutions to be observed by the user (i.e. decision-maker). While other methods, based on random or heuristic techniques, are faster and inexpensive, they may not be able to find the genuine ‘best’ solution (i.e. occasionally only near to optimal solution) (Nigel 2002; Steinbrunn *et al.* 1997). Moreover, the shape of the decision solution space is sometimes extremely irregular, making it difficult for a non-systematic search method to explore all significant regions.

As mentioned before, Genetic Algorithms are superior when compared against the other two non-systematic search associates, namely TS and SA. Both TS and SA methods utilise one solution and compare it to another; whereas GA employs a set of solutions to do the job simultaneously. Furthermore, Mayer *et al.* (1998b) found that despite the successful usage of TS in other disciplines, it still presents methodological drawbacks when applied to optimisation models of an agricultural system when high dimensionality and presence of continuous variables occur in the systems. Moreover, Mayer *et al.* (2005; 2001) state that SA has proven reliable in finding optimum solutions, although the excessive time spent in finding the optimum solution has been identified as a major drawback. However, Matthews (2001) and Ducheyne (2003) note that GA seems to be a suitable optimisation method for agricultural models (Figure 2.22).

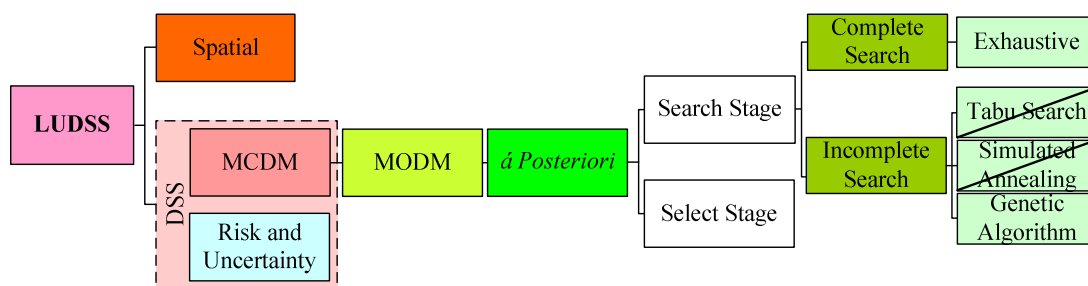

Figure 2.22 Selection of the method of assessment: *á Posteriori* articulation, with two different search techniques: Exhaustive Search or Genetic Algorithm

An optimisation method is also required to find an optimum solution. There are a number of different types of methods for such a task: MADM methods, Compromise Programming and *Pareto Optimal*. MADM is considered for the present research, since all feasible solutions have been predetermined in the searching stage. In such a case, the decision-maker is required to articulate preferences prior to the start of the procedure, or progressively during the implementation (see Section 2.5). Compromise Programming is a “distance” method using the minimum (linear/weighted) distance to the utopian solution point as the objective function. In *Pareto Optimal* theory, the optimal solution will be the non-dominated solution or *Pareto Front*. In such a case, a set of solutions can be generated numerically, based on the preference given by a decision-maker. Another advantage of this method is the possibility to visualise the *Pareto Front* of the overall result.

As the objectives of the agricultural model proposed in this research are to maximise profit and minimise negative environmental effects, it will be highly beneficial if the user is able to pick the most feasible solution by observing the overall solutions while judging the advantages and disadvantages of the circumstances. Based on all these considerations, it was decided that the *Pareto* theory is most suitable to the purpose of the research (Figure 2.23).

To summarise, the following facts are known about this research (see Figure 2.23):

1. The decision objective of Land-use planning decision-making will be in a multi-criteria format;
2. Since the decision solution space initially lacks a discrete format, a Multiple Objective Decision-making (MODM) approach has to be adopted in the modelling process;



3. MODM methods can be classified into four categories based on the preference articulation: *Never*, *á Priori*, *Progressive* and *á Posteriori*; the preliminary analysis concluded that the *á Posteriori* approach is the most suitable method due to its flexibility in incorporating the dynamic characteristics of the decision-maker preference.
4. The *á Posteriori* approach is divided into two stages; namely, searching “solutions”, and then selecting the best solution based on the preference of the decision-maker. Methods used in the searching stage can be categorised into systematic and non-systematic search exploration search methods. The Exhaustive Search method is an example of the former, while Genetic Algorithm characterises the latter. The capabilities of each of these methods will be further assessed in Chapters 3 and 4.
5. There are a number of selection (optimisation) methods, such as MADM methods and the Pareto Theory approach. In MADM, the decision-maker is served with the final solution based on their preferences without a choice. Conversely, the Pareto theory offers a user the option to choose the solution they think is the best. Since the decision objective at hand is moderately simple, it is decided that the best method to use is visualisation and Pareto Optimal.

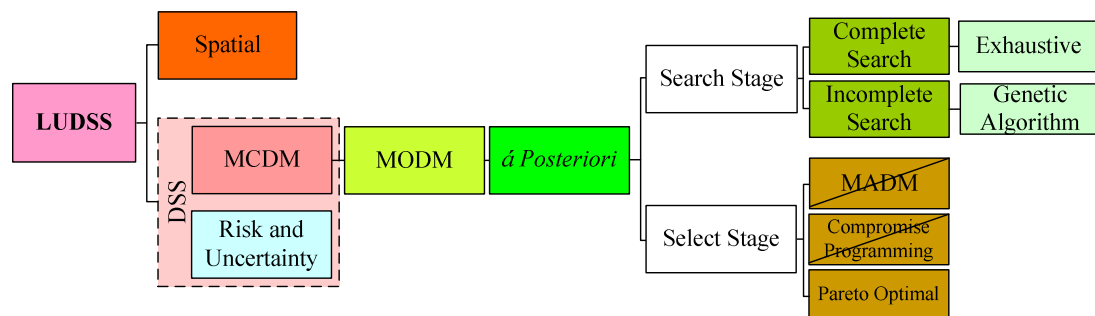

Figure 2.23 Selection of the *á Posteriori* articulation:  
Pareto Optimisation method for the selection stage

### 2.8.2 Decision-making under uncertainty

As mentioned in Section 2.7.1, risk (uncertainty) modelling methods can be categorised into three main approaches: Mathematical programming with built-in risk assessment, stochastic simulation and knowledge-based methods.

Mathematical Programming with a built-in risk component, such as Risk Programming and Stochastic Programming, are proficient methods. However as concluded in Section 2.8.1, Mathematical Programming is not always capable of solving multiple objective problems adequately. Since the problem at hand, is by nature, a multi-objective problem, the path towards a Mathematical Programming method was abandoned.

Knowledge-based approaches utilise prior information or expert knowledge to update current information. While these methods are powerful due to their capability to reduce uncertainty, as well as, finding the most preferable options based on reasoning under uncertain conditions; they are constrained by the fact that expert opinion or prior data is required. Experts' opinions tend to change over time, and vary from one expert to another. Thus, the knowledge given is based on the experts' experience and knowledge. Unless the experts employed are capable and knowledgeable professionals, the exercise of finding the preferable options can be undermined. Likewise, historical data are another possible source of prior information, but it may be scarce or not available.

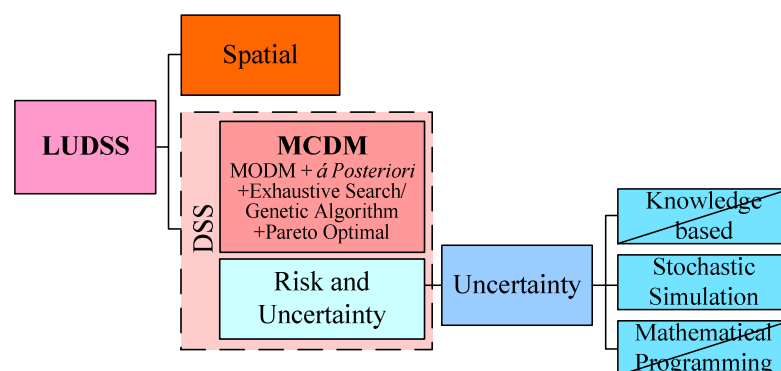

Figure 2.24 Incorporating the uncertainty element to account for risk

Due to the dynamic nature of real world agricultural systems, numerous possibilities may occur in the future. Monte Carlo analysis incorporates the uncertainty of agricultural systems simulations of all the possible scenarios which are, in turn, evaluated as the expected outcome of the system. In addition, Monte Carlo simulation is an arbitrary “black box” which is not restricted to linear, monotonic or continuous events. For this reason, Monte Carlo simulation is the technique chosen to model risk and uncertainty (Figure 2.24).

While the Monte Carlo method is seen as beneficial for this project, the information required fully depends on the problem itself. For this reason, Bayesian Probability theory will also be integrated within the system. Given that objective information is not always readily available, subjective information in the form of knowledge will be utilised.

## **2.9 Chapter Summary**

This chapter establishes the scene of the whole-farm decision-making framework and examines potential approaches to be employed as a Land-use Decision Support System (LUDSS). It is shown that whole-farm decision-making is a complex process, which commonly has multiple competing objectives to satisfy. Therefore, a sophisticated LUDSS is required to incorporate three different aspects: spatial, nature of the problem Multiple Criteria Decision-making (MCDM), and risk and uncertainty.

The rationale behind the choice of approaches to be utilised in different aspects of the system is analysed in Section 2.8. A Multiple Objective Decision-making (MODM) - *á Posteriori* approach is regarded the most suitable method due to its flexibility to adapt to a wide range of varying preferences of the decision-maker. It is concluded that the most suitable approaches to search for possible solutions is: the *Exhaustive Search* method and *Genetic Algorithm*; while *Pareto* theory is chosen as the method to select the optimal solution. In addition *Monte Carlo* simulation is deemed to be the most suitable approach to incorporate the uncertainty involved in whole-farm planning.

## CHAPTER 3

### EVOLUTIONARY ALGORITHMS FOR MULTIPLE OBJECTIVE OPTIMISATION

The previous chapter discussed a number of different optimisation schemes to carry out multiple criteria decision-making (MCDM). Two of them appear to rise above the rest: the exhaustive search method, a simple and systematic search method; and the Genetic Algorithm, a non-systematic search method.

It was found that evolutionary methods, such as Genetic Algorithms (GA), are a valuable alternative that call for deeper examination and possible development of a search prototype (Figure 3.1).

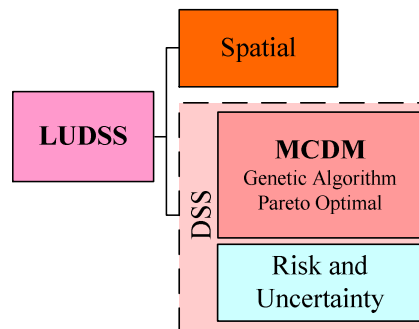

Figure 3.1 MCDM: Genetic Algorithm and *Pareto* dominance

This chapter will discuss Evolutionary Algorithm as one of the promising methods to be employed for determining an optimum solution. The chapter will also include a comprehensive description of a possible evolutionary search prototype to be used as part of the Land-use Decision Support System. Most of the terminology defined in this chapter will be used continuously hereafter.

### 3.1 Evolutionary Algorithms

An Evolutionary Algorithm (EA) is a generic population-based optimisation method that simulates biological evolution using a general-purpose search algorithm to seek the optimum solution to a problem. It utilises evolution mechanism operators such as: *selection*, *crossover* and *mutation* (Michalewicz *et al.* 1996). There are many different forms of Evolutionary Algorithms (Bäck and Schwefel 1996): Genetic

Algorithm (GA) (Holland 1975), Genetic Programming (GE) (Cramer 1985), Evolutionary Strategies (ES) (Rechenberg 1965), Evolutionary Programming (EP) (Fogel *et al.* 1966), Memetic Algorithm (MA) (Moscato and Cotta 1999), Ant Colony System (ACS) (Dorigo *et al.* 1996) and Ant Colony Optimisation (ACO) (Dorigo and Di Caro 1999).

The basic principle of all Evolutionary Algorithms is: evolution, where natural selection is the main driving force for a population of individuals to survive when subjected to environmental pressure (Eiben and Smith 2003). The main difference between the various types of GAs is in their technical approach of the subject, for example in the representation of candidate solutions as binary or real values in GA, real-value vectors in ES, trees in GP and others (Eiben and Smith 2003).

The term EA will be employed to refer to all forms of evolutionary methods. The subject of EA has significant literature (see Beyer *et al.* (2002), Coello Coello (2000b), Fogel (2000, 1997), Bäck *et al.*(1997), and Koza (1997)). A complete overview of EA operators and components is beyond the scope of this thesis. Instead, this chapter will attempt to summarise some basic elements and components employed in EA and assess how they can be applied in the context of this research.

### **3.2 Evolution: Adaptation and Speciation**

“Evolution” and “Natural Selection” was a revolutionary theory proposed by Charles Darwin (1958). He claimed that organisms evolved over time, essentially stating that evolution is a change in the gene pool of the population, which spreads over many generations, whereby populations evolve but individuals within the population do not (Colby 1996).

“Adaptation” is an adjustment by individual organisms to better fit within the environment in which they live, in other words to struggle for existence. In the biophysical world, adaptation is also called microevolution and it is a form of evolution. In a sense, microevolution is the process by which variations of certain species are created. Another type of evolution is macroevolution, usually called *speciation*. Macroevolution denotes the slow progressive changes that occur to a species over time to form a new species.

Evolution processes occur due to a number of distinct mechanisms: natural selection, mutation, genetic drift, gene flow and recombination. Natural selection is the differential survival and reproductive success of classes of genetic variants in the gene pool capability (Colby 1996). In a sense, the condition of the environment is shaping the population (Figure 3.2). If an organism possesses a certain trait required to struggle for existence in its environment, this will give it an advantage to survive and reproduce (i.e. *selection* and *crossover*), while others without the trait will not. Natural selection is blind and it does not have a fixed path, though it is capable of forcing organisms to adapt to their ecological *niches* (Colby 1996). Over time, organisms with a certain trait become increasingly dominant and when this situation occurs, this is called *selection pressure* towards that particular trait (Replicators: Evolutionary Powerhouses 2000).

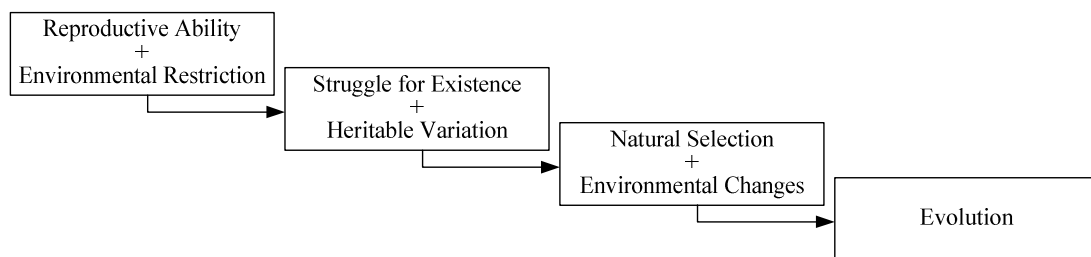

Figure 3.2 The process of *Natural Selection* (University of Michigan 2005)

Another mechanism of evolution is *genetic drift*. Genetic drift is fundamentally similar to natural selection. The major difference between both methods is that genetic drift is a stochastic process, which randomly passes on the trait from one generation to the next (Moran 1993a).

Natural selection and genetic drift are mechanisms, which decrease genetic variation. Other types of mechanisms that increase genetic variation, are mutation, recombination and genetic flow. Mutation is one of the evolution mechanisms that operate by altering the genetic material of organisms. Mutation can be harmful, beneficial or neutral. It can be caused when a heritable error occurs during the replication of the material. Moreover, in a lot of cases organism mutates to adapt to changing environment.

Recombination is the evolution mechanism that works by combining the chromosome of the parents, which in effect is a gene shuffler to generate a new combinatory set of chromosomes (Colby 1996). Genetic flow, or gene migration, happens when new organisms emigrate from their population and migrate into another population. The breeding between foreign citizens with the local citizens of the population will bring new traits into the local gene pool. In addition, the emigration of the organism may also cause the removal of a trait in the population, which subsequently may change the course of the future descendants. For a comprehensive reading about this subject see Ridley (1993) and Moran (1993b).

It also needs to be clearly identified that from one population to another, a successful trait in competing to survive may not be the same. A trait may survive in a population, but may not be able to survive in another population. Moreover, within any population there are certain organisms that have adapted to optimal traits (global optimal), but within the population there are also other organisms that possess traits that are almost as adapted (local optimum) (Colby 1996).

An organism of any species is made up of millions or even trillions of cells. Cells provide the structure and functional unit of any organism. Cells make copies of themselves in order to reproduce inheritance matters. Figure 3.3 shows the composition of a cell by its nucleus and chromosomes. Each chromosome is made up of genes (Figure 3.3), which in turn are made up of DNA; the hereditary material. The information in DNA is stored as a code.

In summary, genes can be described as manuals and blueprint information for every organism, which gives instructions to construct molecules that make the organism function. For example, genes determine the colour of the eyes, hair and skin. The different possible settings for a gene are referred to as *allele* (Luke *et al.* 1999).

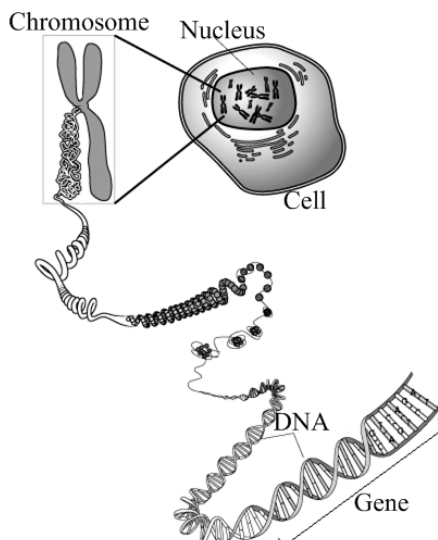

Figure 3.3 Chromosomes;  
Source: Access Excellence The National Health Museum (1999)

Genome (genotype) is a complete set of hereditary instructions required to build and maintain a living example of a particular organism. Every cell within the organism contains a copy of its genome. The biological information within the genome is programmed in DNA. A chromosome is made up of a single DNA string while a gene is a particular part of the Chromosome's DNA string (National Center for Biotechnology Information 2004). Figure 3.4 illustrates the relationship between the genome and other elements. DNA is contained in the gene box, genes are contained in the chromosome box while chromosomes make up the genome box (Genome News Network 2003). While the genome is the internally coded inheritable information carried out by organism, the phenome manifests physical properties of the organism (Lewontin 1992). For further definitions and concepts of the phenome and genome see Mahner and Kary (1997).

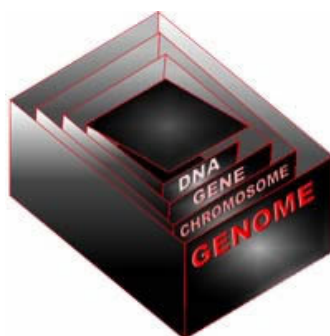

Figure 3.4 Chinese box representation of DNA, Gene, Chromosome and Genome;  
Source: Genome News Network (2003)



### 3.3 Basic Elements of the Evolutionary Algorithm (EA)

In general, the EA procedure is a gradual development of processes to achieve evolution progression (Figure 3.5): initialisation of population, breeding (iteratively) and termination when a certain goal has been reached. In the breeding process, a number of individuals will be selected and put into the mating pool, where pairs of parents will be selected to be crossed over and (sometimes) mutated to produce offspring. The offspring will then be inserted into the population by employing a replacement method.

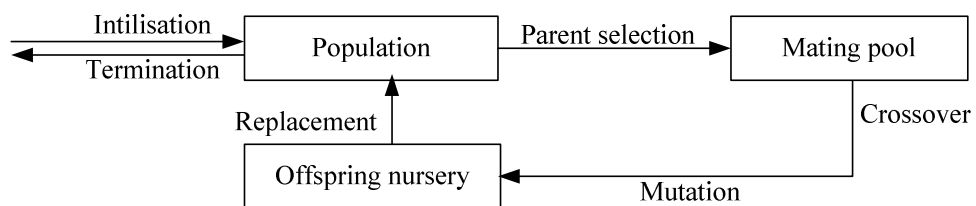

Figure 3.5 Basic structure of GA (Eiben and Smith 2003)

This breeding process can be viewed as two different strategies: generalisation and steady state EA. In general EA (terminology:  $\lambda = \mu$ ), for every iteration a complete set of offspring will be generated and placed in the nursery where replacement procedures will be employed to insert offsprings into the population (replacement process). In the steady state EA (terminology:  $\lambda = (\mu + 1)$ ), strictly speaking, there is no offspring nursery. Instead, the offsprings are produced gradually and the replacement procedure is done after every new offspring is born.

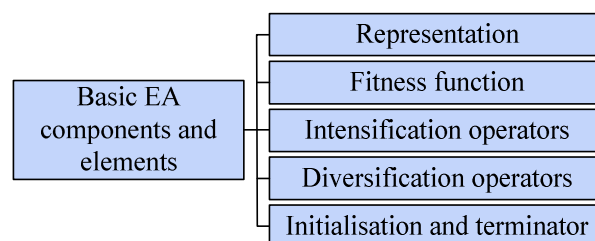

Figure 3.6 Elements and components of EA

Within the breeding process (Figure 3.6), two types of forces are being applied to the population in order to have a successful evolution progress: *intensification* and *diversification*. Intensification processes are usually achieved by utilising two

selection operators: parent selection, crossover and replacement operator; while mutation operator instigates the *diversification* advances.

### 3.3.1 Candidate representation

EA is an attempt to mimic the procedure of evolution and in particular the survival of the fittest. The fittest individual will survive. Hence the core of EA is the population pool of individual candidates. The candidates will act as a solution point within the solution space of the EA model.

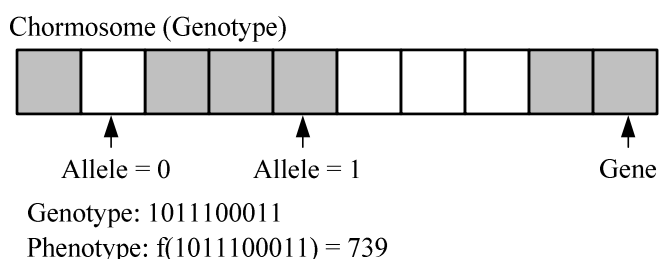

Figure 3.7 EA candidate representation

The terms such as genotype, phenotype, chromosomes, genes and alleles, applied in the biological world, are also utilised in EA models (Figure 3.7). The physical expression of the candidate organisms within the context of the original problem is referred to as phenotype, while the individual itself is represented by a string (or a string of strings) called genotype (van Veldhuizen 1999). The genotype is generally made up of one or more chromosomes. The chromosomes are made up of genes that are capable of capturing alleles.

An allele is a value of a trait. The “evolution” happens due to the variation of the allele’s value over a period of time. Locus is referred to as the position of a particular gene within the chromosome (van Veldhuizen 1999). For instance, in Figure 3.7, the chromosome is representing binary bits in a string of ten. The allele value can be zero or one, while the genotype itself will be 1011100011 and the phenotype will be 739.

*Definition 3.1 Chromosome refers to a set of whole-farm land-use plan.*

*Chromosome inhabits the decisive space with corresponding objective assessment values allocated in the objective space (Figure 3.8).*

*Definition 3.2 Gene refers to a paddock or Land Management Unit (LMU) with a specific land-use management.*

*Definition 3.3 Allele refers to the land-use management of a particular paddock or LMU. They are the individual selections for a particular gene.*

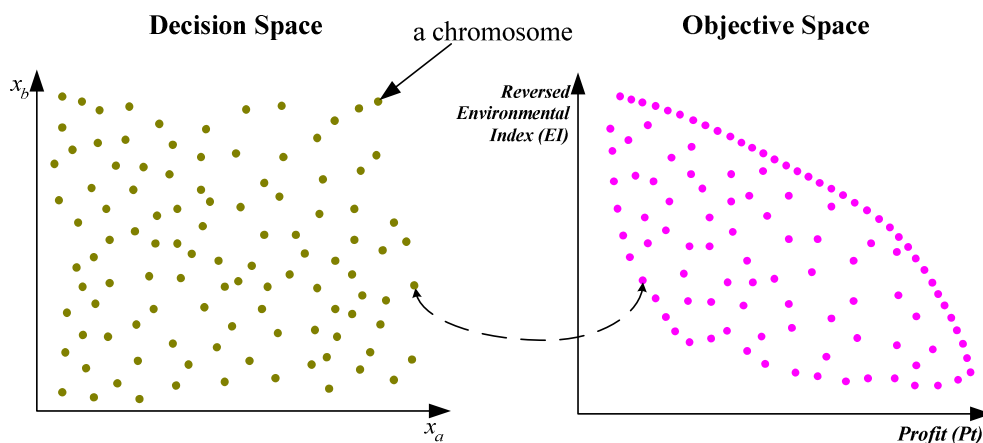

Figure 3.8 Decisive spaces (two decision variables  $x$ ) and the corresponding objective space (two objective variables)

The terms such as chromosome, gene and allele will continuously be used in this research to represent whole-farm land-use plan, paddock or *LMU*, paddock land-use management options and their objective values respectively.

Traditionally, the allele value is based on binary values. However, alternative allele representations have been proposed to enhance EA performance for different applications. Some of the most applied allele representation types are based on real coded (Michalewicz 1996), order coded (Goldberg 1989) and messy representation (i.e. mGA) (Goldberg *et al.* 1989).

### 3.3.2 Intensification operators

Intensification operators attempt to preserve good chromosomes and combine their good features to produce a better chromosome. Three common intensification operators are: parent selection (see Section 3.3.2.1), crossover (see Section 3.3.2.2) and replacement operator (see Section 3.3.2.3). The parent selection operator performs the selection of individuals from the population into a temporary household, the *population mating pool*, ready to be mated to produce offsprings for the next generation. The crossover methods attempt to introduce diversity into the population by mating two candidates, produce (hopefully) a new strand and possibly

improving offspring into the next generation. The replacement operator performs the selection of the (new) offspring to be inserted into the next generation population.

The individual to be selected is not just any other individual, but it should be the fittest individual or the best individual that may provide a better gene for the sake of the survival of the population. In general, a chromosome is defined to be better than another by using its *fitness level* (a.k.a. *fitness value*) determined by a *fitness function*.

*Definition 3.4 Fitness function is a predefined quality criterion (i.e. objective function) which evaluates the fitness value (i.e. objective value/s) of a solution.*

### 3.3.2.1 Parent selection operator

There are many different kinds of reproductive “selection” operator methods. One of the oldest of these is the *Roulette Wheel* method (see Figure 3.9). This method uses all of the fitness values of individual chromosomes to form a *relativity value* (*percentage value*). A higher fitness value of a chromosome will provide a relatively larger percentage of the chromosomes to be chosen. This method is called the *Proportional Selection* approach. The problem with this approach is that it is highly influenced by the ability of some superior chromosomes. For further information see Goldberg (1989).

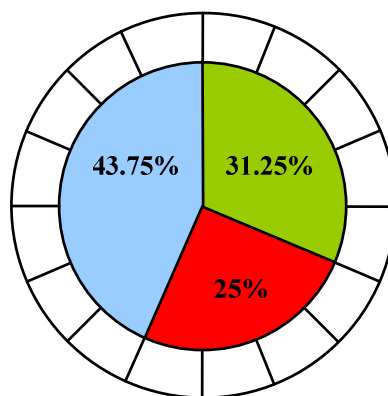

Figure 3.9 The Roulette Wheel

Other reproductive “selection” methods include: the tournament selection, ranking selection, elitist selection, the partner preference and the guided method. Each of these methods can perform better than the others depending on the problem at hand (Blickle and Thiele 1996).

In the Tournament selection approach, a number of individuals will be randomly selected from the population to form a group. The fitness values of the chromosomes within the group will be compared with one another, and hence the chromosome with the best fitness will win the tournament. This overall process will be done iteratively. Further reading regarding Tournament selection can be found in Miller and Goldberg (1995) and Blickle and Thiele (1995).

In the Ranking selection approach, the selection is accomplished by ranking the chromosome based on their fitness. A selection probability is then assigned to the chromosomes based on the rank itself with the fittest individual possessing the largest rank. The probability applied can be in linear or exponential format. For further reading see Michalewicz (1996).

Elitist selection methods (de Jong 1975) are accomplished to ensure that the best individual/s will survive from one generation to another. In this method, pairs of individuals, such as the parent and offspring, or an individual with another most similar individual, will be compared, and whoever is fitter will stay and the other must leave.

The Partner preference method is based on the preference of the partners. Some of the methods are: *seduction* (Ronald 1995), *incest prevention* (Eshelman and Schaffer 1991) and *assortative mating* (De et al. 1998). *Seduction* aims to pick parents who are related to one another. The first parent is chosen in a traditional approach while the second parent is chosen based on the first parent preference. The fundamental principle of *incest prevention* is to avoid the breeding between individuals who have similarities (i.e. similar ancestor). In the *assortative mating* methods, the mating is done based on the similarity or dissimilarity of the parent chromosomes.

In the Guided method, selection is accomplished by examining the *mutual fitness* of the first parent, which is selected randomly, and all of the candidate partners within the population. The candidate partner who has the best *mutual fitness* with the first partner will be chosen. Further reading regarding the Guided method can be found in Rasheed (1999) and Rasheed and Hirsh (1997).

### 3.3.2.2 Crossover operator

Once the potential chromosomes are accumulated in the pool then the crossover operators will start to work. The aim of the crossover operator is to marry parent chromosome genes (which are selected carefully as the fittest or the best combination) and to create a new offspring of chromosomes by employing the crossover probability,  $p_{cross}$  (i.e. the crossover rate). The crossover rate indicates the percentage of the new individuals, which will be produced based on the crossover operation.

The common method is to randomly choose some crossover point (i.e. a single point) where the parents' chromosomes are divided into two sections. The first section of one parent is then united with the second section of the other parent (Figure 3.10).

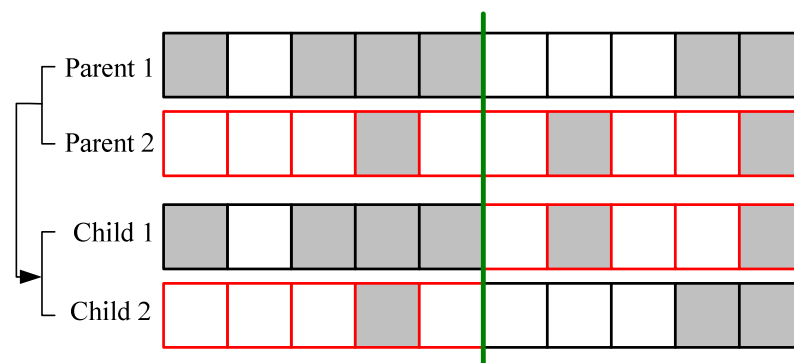

Figure 3.10 The *Crossover* process

There are other different extended crossover operator approaches, such as multi-point, uniform (Syswerda 1989) and multi-parent crossover. Multipoint crossover is a generalisation method of the one point crossover method, which is accomplished by selecting several random cut points on the parent chromosome to be crossed over and produce children (Spears *et al.* 1993).

The uniform crossover approach is accomplished by employing Probability theory to randomly select a gene of the parents, either from the first or the second parent, as the corresponding gene of the child by employing a crossover mask. In uniform crossover, the reproduction between two individuals will only be one offspring, where each gene in the child's chromosome is the gene copied from either parent

determined by a randomly generated crossover mask of zeros and ones (Beasley *et al.* 1993).

In the multi-parent crossover method, more than two parents are used to create an offspring. The number of parents will be referred as the *arity* of a crossover operator (Eiben and Back 1997). Other crossover methods are described by Eiben (1997) and Eiben and van Kemenade (1995).

### 3.3.2.3 Child insertion (replacement) method

Other intensification operators are replacement operators, which insert a child into the next generation population. There are a number of different replacement methods, namely: simple, local elitist, random elitist, uniform, roulette wheel, absolute fitness, locally elite and random elite replacement.

The simple replacement is the easiest replacement scheme where the next generation is formed by the offspring of the previous generation. The local elitist replacement method compares the parents and their offspring fitness and whoever is better will enter (or re-enter) the population. The random elitist replacement method is accomplished by comparing the fitness of an offspring with a randomly selected individual from the population. The roulette wheel replacement procedure is similar to the roulette wheel selection method, where the chance of being picked is proportional to the fitness of the individual chromosomes. The absolute fitness replacement method is done by choosing the weakest individual from the population and replacing it with an offspring. There are many more replacement methods available.

### 3.3.3 Diversification operators

To maintain the diversity within the population, EA possess two diversification operators: crossover (recombination) and mutation. The mutation operator, performs a sudden mutation to introduce a different variation.

Even though selection and crossover operators are able to produce an astounding amount of parent/offspring solutions, a good solution depends on the initial population. The range of the initial population may not be large and diverse enough

to capture the whole solution space. The *mutation* operator is introduced to overcome this particular drawback.

This particular method takes place after a *crossover* is executed. The method is done by randomly switching the gene value of an offspring chromosome (Figure 3.11) from its initial state, with some probability,  $p_{mutate}$  (i.e. the mutation rate). Generally, the *mutation* operator is accompanied by a probability value, which is used as “*mutation* frequency indicator”. The probability should be chosen with caution. If the value is set too high then the GA could be turned into a primitive random search.

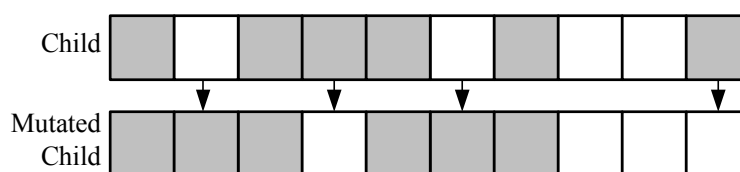

Figure 3.11 The *Mutation* process

There are a number of different methods in processing mutation operators: Flip-bit methods, boundary methods and others. Flip-bit is done by flipping the value of the randomly selected gene (for binary genes only); whilst the boundary method is accomplished by substituting the value of the selected gene by its extreme values.

### 3.4 Working on Multiple Objective Evolutionary Algorithm (MOEA)

In EA, there are a number of complex issues. The most significant issues are related to parameter settings and the problem of premature convergence. In addition to these common obstacles, the task at hand is not a simple single objective decision-making (SODM), but a multiple objective decision-making (MODM) problem; and like any other MODM problem, there is a need to establish a suitable approach to efficiently deal with the trade-off functions.

Operators used in a Multiple Objective Evolutionary Algorithm (MOEA) context possess built-in requirements referred to as parameter settings. EA employs a large number of operators, which means that the requirements of the parameter settings and their unruly complications are extremely difficult to solve.



Another significant issue in employing EA models (Figure 3.6) is dealing with multimodal optimisation. Most real world issues involve multiple optimum solutions, either as a global or local optimum. Like any other non-systematic search model, EA models face a problem known as *premature convergence*. During the convergence of the population towards an optimum solution, the EA model can reach a trough for a local optima, and be trapped inside the low point (Figure 3.12). When this occurs, the population will lose its diversity before the objective is met, and any crossover between individuals will not have any effect at all. EA models attempt to deal with this problem by integrating techniques to maintain population diversity (Jensen 2001; Spears 1994).

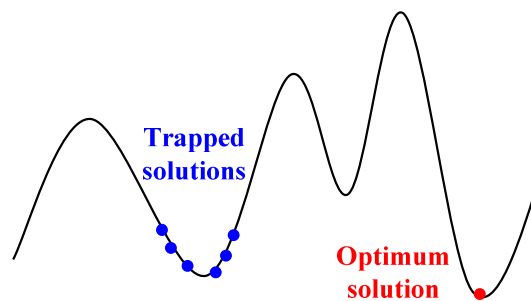

Figure 3.12 Possible trapped solution

#### 3.4.1 Parameter settings

EA possesses quite a number of operators which require parameter settings to perform appropriately: population size, mutation rate, crossover rate, selective pressure rate and others (Eiben and Schoenauer 2002). The dilemma is that sometimes the outcome of one individual parameter setting is unpredictable and can give a significantly different result to another (Droste *et al.* 2000). Since there are a number of different parameter settings required, and since they need to work as a team, the problem can sometimes become uncontrollable. Therefore, setting an “appropriate” parameter is a significant step when using the EA approach.

Some experiments have shown that the effectiveness of a GA model is highly determined by the population size (Chiwiacowsky *et al.* 2004; Balakrishnan 1993). Goldberg (1991) states that the larger the GA population, the better chance of finding a global solution, at the expense of the computation cost. Schlierkamp-Voosen and Mühlenbein (1996) work on the adaptation of the population size by adjusting the

dimension of the subpopulation, which has the best maximum fitness value in a certain number of generations.

While some work with varying population size, others are working on the tuning of the crossover rate. Suzuki (1998) mentions that the role of the crossover rate is one of very high significance for determining the speed of the evolution. This was confirmed by Luke and Spector (1998), who did a relative effectiveness study between the mutation, crossover and the combinations of mutation and crossover in Genetic Programming based on a wide range of parameter settings. In their studies, it is shown that based on appropriate parameter settings, the crossover operator has some advantage over the mutation operator.

Traditionally, the parameters were initially set as static by identifying the best possible parameter value to be used for the model. However, a more recent development proved that in some cases, an adaptive parameter value may provide a better result. Julstrom (1997) utilises a mechanism, which provides an adaptive probability value to the operator based on its contribution to the new generation created. Herrera and Lozano (1996) employ a fuzzy logic controller for the adaptation of the operator parameter.

The extension of the adaptive approach is a self-adaptive approach. In this approach, the adaptation of the parameter value is based on the information provided by the GA during its run. In the self-adapting method, the search parameter value is encoded within each individual chromosome instead of a fixed global parameter (Schwefel 1981). Bäck *et al.* (2000) propose a model which utilises an existing self-adaptive mutation rate mechanism, applying a new mechanism for self-adaptive crossover rates, as well as, enhancing an existing adaptable population size model. A comprehensive review about adaptive and self-adaptive parameters can be found in Beyer and Deb (2001), Droste *et al.* (2000) and Eiben *et al.* (1999).

However, it needs to be clarified that even though adaptive (or self-adaptive) parameter values are said to be superior, Tuson and Ross (1998) state that this is not always the case.

### 3.4.2 Multimodal surface

As mentioned in the preceding sections, when the surface area is a multimodal space, a simple EA model seems to lose the population diversity rapidly and converges towards a single solution. The reason for this particular problem is that EA assigns an exponentially increasing number of trials to the best-observed region of the search surface.

In a simple unimodal search space, the ability of EA to concentrate on a promising search area and converge rapidly to the optimal solution is, in fact, a good sign. However, in many real world problems the search space is naturally overwhelmed with complicated multimodal surfaces. In such cases, GA is superior in searching a specific local area, which allows it to converge fast towards the optimum solution of that local area space. Nevertheless, the existing global solution may never be discovered (Lau *et al.* 2004). Some of the methods proposed to control the diversity of the population and distribute the individuals over different areas of the search space are: the *niching method*, *restricted mating* and *structured population* (Gustafson 2004; Spears 1994), briefly described hereafter.

#### 3.4.2.1 Niching

The *niche* concept is borrowed from ecology. Odum (1971) states that an ecological niche of an organism, biologically speaking, is based on where the organism lives (i.e. address), as well as what the organism does (i.e. profession). A niche is a metaphor of an environment sub-space with a finite resource, where different types of life inhabit the area, which causes localised competition for resources (Sareni and Krahenbuhl 1998). *Niching methods* are EA mechanisms that are capable of establishing and sustaining a stable subpopulation/s across the search space. This is done with the purpose of promoting diversity across the most prominent regions while allowing convergence to occur within local regions (Mahfoud 1995). Different classes of niches are further detailed in Brownlee (2004).

Some of the most famous niching methods are: *Preselection*, *Crowding* and *Sharing*. In the *Preselection* method (Cavicchio 1970), the fitness of the newly generated offspring is assessed by comparing it with its parents. If the offspring is better than its parents then it will succeed to the next generation and replace its parents.

The *Crowding* method (de Jong 1975) is an improvement of the *preselection method*, with the policy that the *weakest with the most similar must die*. This means that the offspring are restrictively generated and inserted into their parental sample population by comparing them with the most similar individual from the population (Gustafson 2004). The *Crowding* method has been extended to: the *Deterministic crowding* (Mahfoud 1992), the *Probabilistic crowding* (Mengshoel and Goldberg 1999), and the *Multi-niche Crowding GA* (Cedeño and Vemuri 1999).

The *Sharing* method was proposed by Holland (1975) and developed into the *Fitness Sharing* mechanism by Goldberg and Richardson (1987). The fundamental idea behind *Fitness Sharing* is that the individual is required to share the available resources within a particular niche by adjusting downwards the fitness of an individual based on the proportional amount of other individuals in its niche. In a sense, the fitness of an individual degrades progressively if the neighbourhood is increasingly swarmed by other individuals. Improvements and other types of sharing methods are described in Sareni and Krahenbuhl (1998) and Horn and Nafpliotis (1993).

#### 3.4.2.2 Restricted mating

Another prominent method capable of maintaining the population diversity is *restricted mating*. Restricted mating is employed to restrict the coupling of two individuals who are within a certain distance (Zitzler and Thiele 1999), either to assure the dissimilarity (cross-breeding) or similarity (in-breeding) of the individual. Depending on the means of comparison, the tools employed can either be based on the “distance” of the individual or a kind of memory (or tag) as its supplementary attributes (Deb and Spears 2000) (see Figure 3.13).

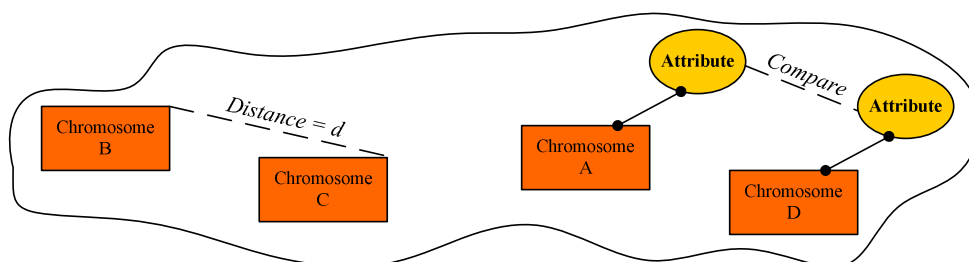

Figure 3.13 Tools employed for comparing chromosomes

Tags, or memory, act as the supplementary attribute information and can contain different individuals' characteristics like: gender, nationality, religion, family, clan, race, ancestor or even species. The main purpose of these supplementary attributes is an effort to create a sub-population (Spears 1994) (Table 3.1).

Table 3.1 Types of different approaches in employing *memory* and *tag*

Usage	Description	Citation
Family tree memory	To prohibit incest where marriage between pairs that have a certain degree of mutual parenthood is not permissible.	Craighurst and Martin (1995)
Memory: Clan (Tabu list)	To distinguish the <i>ancestor clan</i> of the offspring to prevent the mating between offspring that have the same immediate <i>ancestor clan</i> .	Ting <i>et al.</i> (2003, 2001)
Memory: Ancestry	niGAVaPS: records each individual's ID, an ancestry table and a lifetime (i.e. defined according to its fitness and population characteristics).	Fernandes <i>et al.</i> (2000)
Tag bits	To identify the species to which an individual belongs.	Deb and Spears (2000)
Racial tag	Tries to restrict mating from different racial background, instead of marrying pairs from the same race.	Ryan's (1996, 1995)
Religion tag	To restrict the mating between individuals of different religions and the exchange of individuals between religions by conversion.	Thomsen and Krink (2002)
Collective adaptation memory	To act as an ancestral data repository, which a group shares and inherits from one descendant population to another.	Haynes (1997)

#### 3.4.2.3 Structured population and parallel Evolutionary Algorithm (EA)

The fundamental core of Parallel EA approaches are parallel process systems of a set of structured populations (i.e. spatially distributed individuals) (Alba and Tomassini 2002). In this approach, the EA search is performed simultaneously on each structured population and hence it is called *parallel EA (PEA or PGA)*. Each of the subpopulations evolve independently, which may cause a drift of the subpopulation to explore different parts of the solution space (Jensen 2001; Smith *et al.* 1992). There are two common approaches in the parallel model with a structured population (Cantu-Paz 1995; Gordon and Whitley 1993): the *Coarse Grained* and the *Fine Grained (cellular GA)*.

For the purpose of clarification, it needs to be stated that while it is common that a certain type of structured population is employed in the parallel model, this is not always the case. Parallel processes can also be performed in the ordinary EA population. This approach is called the *Global Parallelisation* approach, where the processes of the operators and individual evaluation are parallelised (Chiwiacowsky

*et al.* 2004). The approach has the capability to perform faster than the ordinary EA but the approach is not designed to attack multimodal problems.

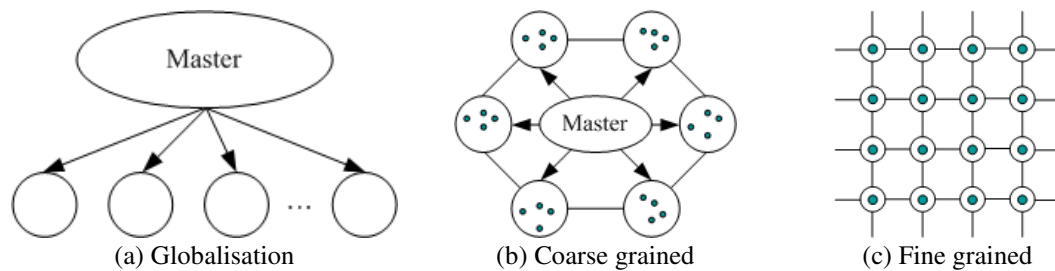

Figure 3.14 PEA population approaches (Alba and Tomassini 2002)

In the *Coarse Grained* approach (Tanese 1989), the population is divided into a number of geographically isolated subpopulations (Figure 3.14). The breeding and survival competition happens within each of the subpopulations and, occasionally, individuals from one subpopulation can *migrate* to another subpopulation to mate. In a sense, this approach is a form of restricted mating in a geographical sense (van Veldhuizen and Lamont 2000a). Some of the methods in the coarse grained approach are the island model and stepping stone model (Chiwiacowsky *et al.* 2004). The difference between these methods is that, in the island model the migration can be from one subpopulation to any other subpopulation while in the stepping stone model the migration is restricted to only the neighbouring subpopulation (Cantu-Paz 1995). Further reading about the *Coarse Grained* approach can be found in Alba and Tomassini (2002) and Bessaou *et al.* (2000).

The *Fine Grained* approach, also called the *Cellular* or *Grid Diffusion* approach or *Massive Parallel*, is accomplished by dividing the population into a large number of small subpopulations, where each subpopulation evolves separately. This is different from the *Coarse Grained* approach, which usually has more than one individual in each subpopulation. Whereas, in the *Fine Grained* approach typically there is only a single individual in every subpopulation and the neighbourhoods are allowed to overlap with each other (Zhaksilikov and Harris 1996). In this approach, each member of the population is often spatially distributed on cells in a grid format to create some kind of local network structure (Rowe *et al.* 1996). Each of these cells work as active individuals and will intermingle only with their immediate neighbours (Folino *et al.* 2003). Once a new offspring is born, it replaces its parents in the cell

depending on the replacement rule. The *Fine Grained* approach is discussed more fully in Lee (2000), Manderick and Spiessens (1989), and Pettey *et al.* (1987).

### 3.4.3 Multiple objective functions (trade-offs)

Another significant topic on MOEA models is how to deal with the trade-offs between the multiple objectives function. MOEA models can be categorised based on their concepts (Jaszkiewicz 2001): Vector-based (scalarisation-function) and *Pareto*-based.

The Vector Evaluated Genetic Algorithm (VEGA) (Schaffer 1985) is an adaptation of single objective GA when applied to a weighted sum of the objectives. Due to the aggregation nature of the method, it is not a suitable method for dealing with the MODM problem at hand. Accordingly, this method will not be discussed further but additional reading on this method can be found in Jaszkiewicz (2001).

It was stated by Deb (1999) that MOEA deals with populations of solutions. In effect, it allows MOEA models to find the *Pareto Optimal* solution in a single run. Table 3.2 lists a number of different MOEA *Pareto* based models. These are discussed more fully by Teo (2003), Deb (2001, 1999), Jaszkiewicz (2001) and Zitzler (1999).

Table 3.2 Different types of MOEA approaches

<i>Pareto</i> MOEA	Description	Citation
SPEA	Non-dominated solutions are stored in an external archive, where the dominance criterion is used for fitness assignment, and employs a tournament mechanism to combine the current and elite population and perform clustering to reduce the redundant non-dominated solution.	Zitzler and Thiele (1999)
SPEA2	An extension of SPEA, which employs the fine-grained fitness assignment strategy. SPEA2 is also equipped with a fixed size archive and different clustering techniques, which intend to avoid losing boundary points.	Zitzler <i>et al.</i> (2002)
MOGA	Each individual is assigned with a rank based on the number of individuals dominating them plus one.	Fonseca and Fleming (1993)
NSGA	The trade-off fronts are graded and peeled off layer by layer to form subpopulations in which fitness sharing is performed on each subpopulation.	Srinivas and Deb (1994)
NSGA-II	Classify and rank the population into a hierarchy of non-dominated layers and employs tournament selection based on the <i>Pareto</i> ranking.	Deb <i>et al.</i> (2000)
PESA	Only non-dominated individuals are allowed to enter the population. A type of crowding method and a density measure are employed to select the member to be mated.	Corne <i>et al.</i> (2000)
PAES	Has an archive of non-dominated solutions and employs the (1+1) local search evolution strategy, which stores a limited amount of non-dominated individuals (based on the crowdedness level within their grid).	Knowles (2002),
NPGA	Combines tournament selection and the concept of <i>Pareto</i> dominance by randomly selecting individuals to form a comparison reference set.	Horn <i>et al.</i> (1994)
MOMGA MOMGA-II	A multi-objective messy GA and fast messy GA, that is based on Building blocks.	van Veldhuizen and Lamont (2000b); Zydallis <i>et al.</i> (2000)
PCGA	Employs rank histograms with the purpose of monitoring the convergence of the <i>Pareto Front</i> .	Kumar and Rockett (2002)
PDE	Employs Differential Evolution (DE), which handles continuous domains, and <i>Pareto</i> -frontier.	Abbass and Sarker (2002)
SPDE	A self-adaptive version of PDE, where mutation and crossover rates are allowed to self-adapt during the process.	Abbass (2002)

### 3.5 Evolutionary Algorithm Search Prototype

The main purpose of this research was to develop a MODM model for farm management problems based on finding optimal trade-off solutions between the competing objectives; in this case, maximising profit and minimising negative environmental effects. The literature reviewed has indicated that EA could be a suitable method for achieving this.

The use of Evolutionary Algorithm (EA) is a powerful evolutionary method for hunting the best solution. Nevertheless, it has been acknowledged above that an efficient EA (or more precisely a MOEA) model is not easily developed. The



minimum requirement of an efficient MOEA model is that it is proficient enough to handle multi-objective functions and that it is capable of handling multimodal cases. Hereafter a preliminary model is proposed.

One of the primary requirements of the MOEA model is that it should be able to handle multimodal cases. In such a case, a parallel EA could be developed in an attempt to handle the problem. The motivation in employing this particular method is its capability to work with a number of smaller structured populations in a parallel manner, which in turn spreads the search wider, as compared to a search done to one large population. Moreover, the significant advantage of Parallel EA is its capability to speed up the process.

Another significant requirement of the MOEA model is that it is required to handle multi-objective problems. *Pareto* dominance, a powerful multi-objective fundamental, can be applied to detect the appropriate superior solution. An adaptive memory, an *external long-term memory*, can be applied to store the superior solutions. The adaptive memory can be assigned to each subpopulation, with the purpose of finding each superior subpopulation solution.

In addition, one of the main problems that a common MOEA model has, is that it is not capable of recognising the path that it has followed before. This is different from a TS model. EA does not possess a *memory*, and does not allow it to remember its previous route, whereas TS is capable of recognising and refraining from taking the same path that it took in a previous (near) generation. Therefore, it is believed that MOEA is required to possess an additional memory termed as *internal short-term memory (tabu list)* to record that (near) past action.

This research proposes the adoption of a hybrid algorithm between TS and GA in a Parallel approach called ‘Tabu Search-Genetic Algorithm Search’ (*TuGAs*) model as an optimisation problem solver. This hybrid method uses the GA fundamentals, which are then linked to the memory element from the TS. The development of *TuGAs* will involve the following steps:

1. Object representation (Section 3.5.1);
2. Fitness function (Section 3.5.2);

3. Operator (Section 3.5.3);
4. Model (Section 3.5.4);
5. Parallel Model (Section 3.5.4.4).

### 3.5.1 Object representation

Matthews (2001) states that although the GA approach has been identified as a potential technique for determining optimum land-use planning, the crucial element in a successful GA application is the translation of the problem into a genotype design.

In this research, a whole-farm is formed by a number of paddocks (or *LMUs*) and the main goal is to determine the most satisfying whole-farm land-use plan system, where each paddock within the farm executes a certain land-use management strategy; the application of which results in the most satisfying result on a whole-farm basis. Essentially, each paddock within the whole-farm works as an individual that undertakes a land-use management strategy, but their achievement as paddocks within a whole-farm is the indication of how well the applications in each paddock are performed. A unique combination of the land-use management from each paddock will then form a whole-farm land-use management plan.

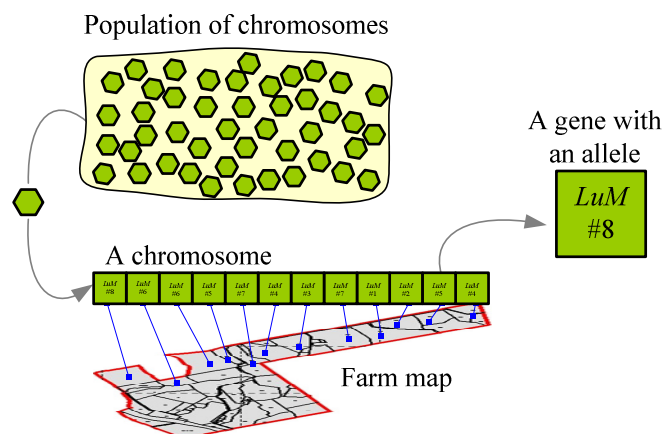

Figure 3.15 Schematic representation of the whole-farm management options based on the EA concept

Referring back to the discussion on the mechanics of the biological world presented earlier in this chapter, a whole-farm land-use management option is represented by a chromosome. Each chromosome has a set of genes, where each gene has a set of

alternative alleles. In this case a gene within a chromosome can be utilised as the representation of each and every individual paddock (or *LMU*). In effect a set of genes will form a chromosome, that maps a whole-farm system (Figure 3.15). Formally, the definition can be set up as the following:

1. A set of chromosomes is called the Population;
2. Each chromosome has a fixed-length and fixed-order of genes;
3. Each gene in a chromosome represents a land block; and
4. The coded value of each gene is the farm management system to be assigned to the land block, which the particular gene represents.

In addition to a basic chromosome, it was considered that an adaptive memory is required in order to memorise the mating rules. The model employs three adaptive memories: *tabu list* (short-term internal memory), and *superior list* (long term external memory). The chromosome representation will be incorporated with an identification number and a *tabu list* (Figure 3.16).

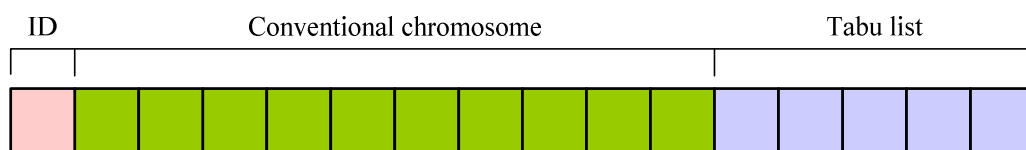

Figure 3.16 Hybrid chromosome representation of *TuGAs*

The *tabu list* records the individual ancestral data exposed to prevent incest, by memorising the previous step through recording the identification number of the parental details. The memory employed will be a *short-term memory*; an extinct chromosome may give an advantageous result when it is reintroduced into the population for future mating and mutating. The size of the *tabu list* will need to be established in the initialisation phase.

Each of the subpopulations is attached to an adaptive memory: the *superior list* (Figure 3.17). This acts as a long-term external memory, which records all the superior individuals from the past. The size of the superior list is a constant  $n$  and is kept full for the whole duration of the procedure.

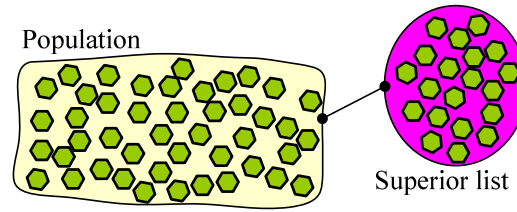

Figure 3.17 Population with *superior list*

In the first generation run, the list is filled with the top  $n$  number of individuals from the initial population. During the run, the weakest individuals are replaced by the newest superior individuals from that particular generation by employing *Pareto dominance*.

### 3.5.2 Fitness assignment and superior individual

The fitness values of a chromosome is assessed and determined based on the two objective variables of the whole-farm land management option that the chromosome represents: *Profit (Pt)* and *Environmental Impact (EI)*.

*Definition 3.5 Each Chromosome  $x$  possesses a fitness value determined by a fitness function, which is based on two variables. The first variable indicates the summation of the overall Profit. The second variable refers to the summation of the environmental impact EI of each paddock  $j$ :*

$$f_1(x) = \sum_j Pt(x) \quad (3.1)$$

$$f_2(x) = \sum_j EI(x) \quad (3.2)$$

Refer to equation (4.50) for the definition of the *overall Profit (Pt)* and equation (4.33) for the *Environmental Impact (EI)*. Moreover, the objective of the optimisation problem at hand is to maximise profit as well as to minimise environmental effect:

$$F_1(x) = \max \left( \sum_j Pt(x) \right) \quad (3.3)$$

$$F_2(x) = \min \left( \sum_j EI(x) \right) \quad (3.4)$$

The fitness assignment is performed with the help of the *Pareto dominance* concept. The individuals are positioned according to their objective function values. For every individual, the fitness value is assigned based on the number of individuals that

dominate it, plus one. Hence, the higher the fitness value, the worse the fitness of that particular individual.

### 3.5.3 Operator

As mentioned in Section 3.3, apart from the GA presentation, the preliminary stage of forming a GA model is to select suitable GA operators related to selection, crossover and mutation.

#### 3.5.3.1 Diversification operators: selection

Two selection procedures are required: Parental selection and survivor selection. The parental selection method chosen is tournament selection (see Section 3.3.2.1), while the survivor selection is based on the random elitist replacement method (see Section 3.3.2.3).

The advantage of the tournament selection method is that the method does not require any knowledge of the entire population. It randomly selects two candidates to be compared and if one of them is fitter than the other, the fittest will be selected. The tournament selection (Figure 3.18) situation can be seen happening in day to day situations where any two random organisms within the population will meet each other and have a match to win a mate, and whoever wins the match (since s/he is a fitter organism, either in physical sense or mental sense) will be able to survive to produce the next generation.

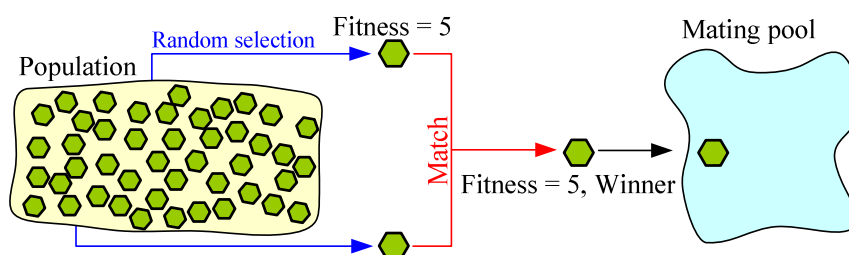

Figure 3.18 Tournament selection process

The random elitist replacement method procedure is similar to the tournament selection method. Both methods randomly choose candidates, which are compared before entering the pool. However, in the random elitist replacement method, an offspring is randomly chosen from the nursery, while an individual is randomly

selected from the old population. Both of the randomly chosen candidates will be compared based on the *Pareto* dominance factor and whichever individual is better, will enter the new generation (see Figure 3.18).

### 3.5.3.2 Intensification operators: crossover and mutation

When there is a set of individuals collected in the mating pool, they are ready to be crossed and reproduced. The crossover operator employed is the simplest crossover method: uniform crossover and then mutation method is employed to introduce diversity into the population.

### 3.5.4 *TuGAs* model

The *TuGAs* model is undertaken using the five stage approach shown in Figure 3.19.

The five stages have the following roles:

1. Initialisation (Section 3.5.4.1): all the parameters are initialised and the initial population set is generated;
2. Evaluation (Section 3.5.4.1): the fitness value of each individual is evaluated and selected according to the tournament selection approach, and candidates are stocked up in a mating pool;
3. Assessment (Section 3.5.4.2): the individuals in the mating pool are assessed for their elitist characteristics and when required, other individual from another population set will be invited. If the individuals in the mating pool pass the assessment test, then the individuals commence breeding;
4. Breeding (Section 3.5.4.3): in the breeding stage, individuals are selected to enter the mating pool by using tournament selection. The parents are chosen from the mating pool and create new off-spring;
5. Migrating (Section 3.5.4.4): when there is an indication that the population stays static for some time, then the migration procedure is performed by inviting individuals from another population to replace randomly chosen individuals from the population.

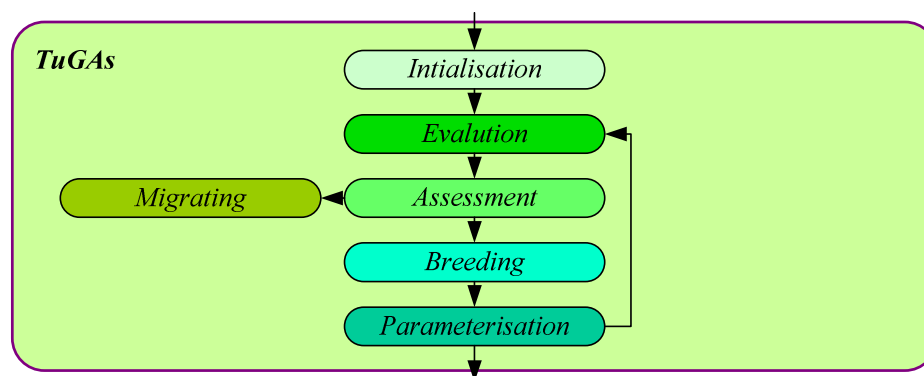

Figure 3.19 General structure of the overall *TuGAs* system

#### 3.5.4.1 Initialisation and evaluation phase

As mentioned above, one of the significant factors in Genetic Algorithm is to employ correct parameter settings. In the initialisation stage, the model requires the setting of a number of different parameters:

1. Initialising the crossover and mutation rate;
2. Establishing the number of islands to be created and the size of the population;
3. Generating the initial population;
4. Initialising counters: ‘no improvements’, ‘iteration’ and ‘static’;
5. Establishing the number of populations (i.e. kingdoms).

Subsequently, after all the parameters have been determined, the initial population set is generated. In the evaluation phase, the chromosome (solution) is set to the allocated land, which is then used to determine the fitness value based on the attributes of the allocated land in order to obtain the objective values and perform the *Pareto* dominance ranking.

#### 3.5.4.2 Assessment phase

The assessment phase determines whether the GA system termination criteria have been met (Figure 3.20). In this phase, all individuals in the population and the superior list are pooled and compared via the *Pareto* dominance method. The top  $n$  superior individual(s) will be stored in the *superior list*. If there are no changes in the superior list then a static counter is initiated and, if there is no improvement in the superior list compared to the past list, then a no-improvement counter will increase. If there are some changes in the list, then the counters will be reset to zero. In this

phase, the population can reach three stages: static, no improvement or possible improvement.

*Definition 3.6* The ‘Static’ status is reached when the static counter has reached a threshold value. This occurs when the population has lost its diversity and is incapable of improving the population. When this occurs, the migration procedure is performed (see Section 3.5.4.4).

*Definition 3.7* The ‘No Improvement’ status is reached when all the possible approaches to inject diversity into the population fail. In this case, it is assumed that the population cannot be further improved and has reached its ultimate goal and evolution is stopped.

*Definition 3.8* The ‘Possible Improvement’ status occurs when there is a possibility to reach a higher state of evolution. In this case, the evolution will iterate again to the next generation of possible improvement through breeding.

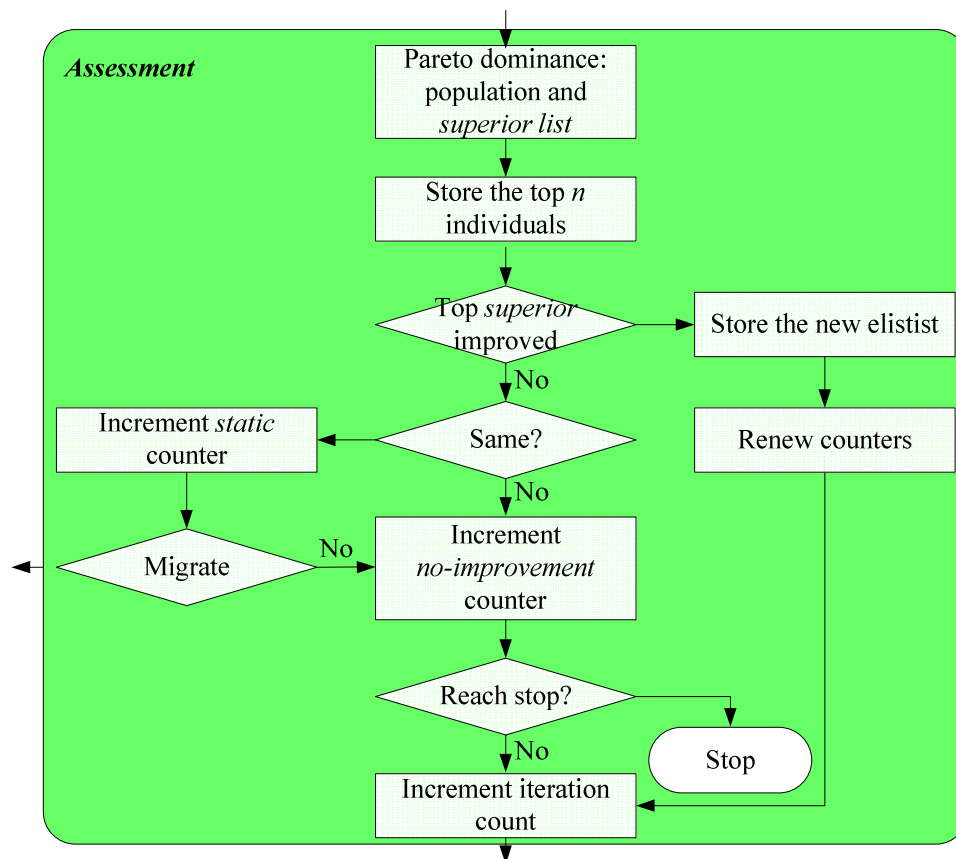

Figure 3.20 Assessment phase processes

### 3.5.4.3 Breeding

After the assessment phase, the population is ready for the breeding phase. In the breeding phase, three original GA operators and tabu processes are used. The basic principle employed in breeding is *incest prevention* on the basis of family



orientation. This means that when two individuals are to mate, the ancestry background of the individual needs to be verified for suitability. In order to apply incest prevention, three rules are being composed: *Parental law*, *incest law* and *inheritance law*.

*Definition 3.9 Parental law: a parent is allowed to have a different mating partner. This is due to the consideration that in nature, the stronger individual will attract more mating partners than the weaker individual.*

*Definition 3.10 Incest law: An individual is not allowed to mate with anyone that is part of their ancestry.*

*Definition 3.11 Inheritance law: Every mating that occurs should produce two offsprings, where each offspring will inherit half the genetic alleles of each parent*

In the process of breeding, the crossover is done, in which case the identification number of the parent is stored in the *tabu list*. When the offspring mates with another offspring, the parents of the offspring will also be matched and purged together (Figure 3.21).

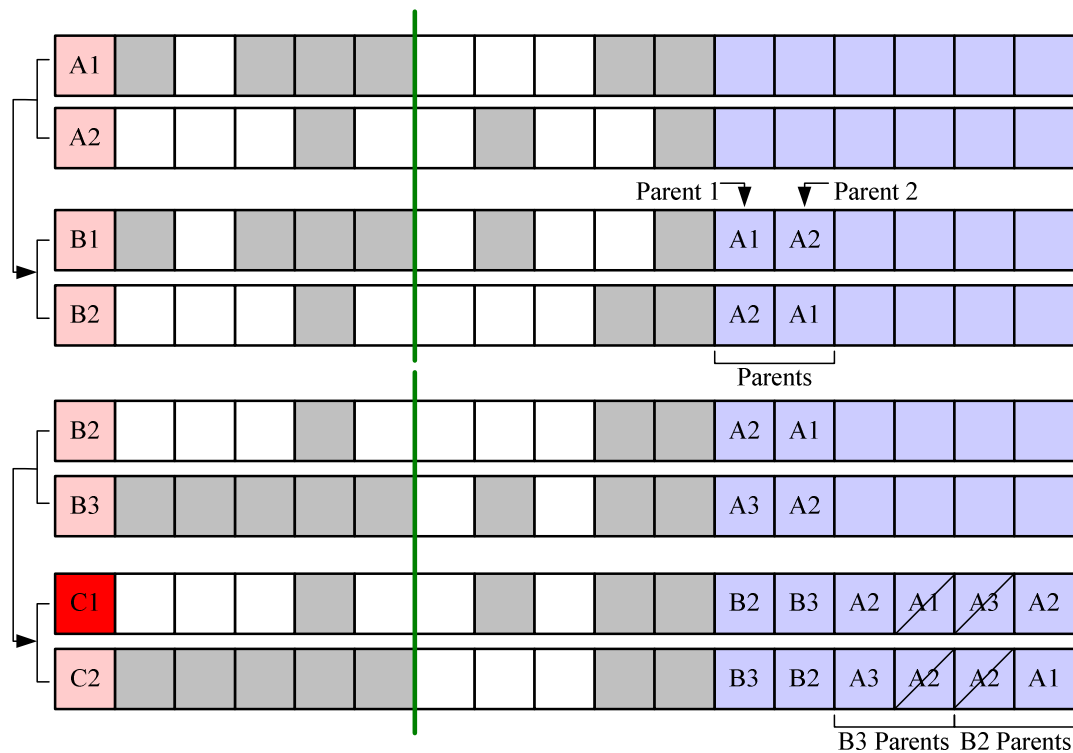

Figure 3.21 Crossover between two parents A1 and A2 to produce two offspring B1 and B2. The population in the generation B will become parents and produce the next generation offspring C1 and C2.

The breeding phase (Figure 3.22) process starts by determining whether the mutation process is required to insert some diversity into the population. This occurs when the *no-improvement* counter (Section 3.5.4.2) has reached a threshold point, in which case an individual from the population will be randomly selected and mutated, if it is unique compared to any other individual in the population. This is performed iteratively until the required number of new individuals has been introduced into the society.

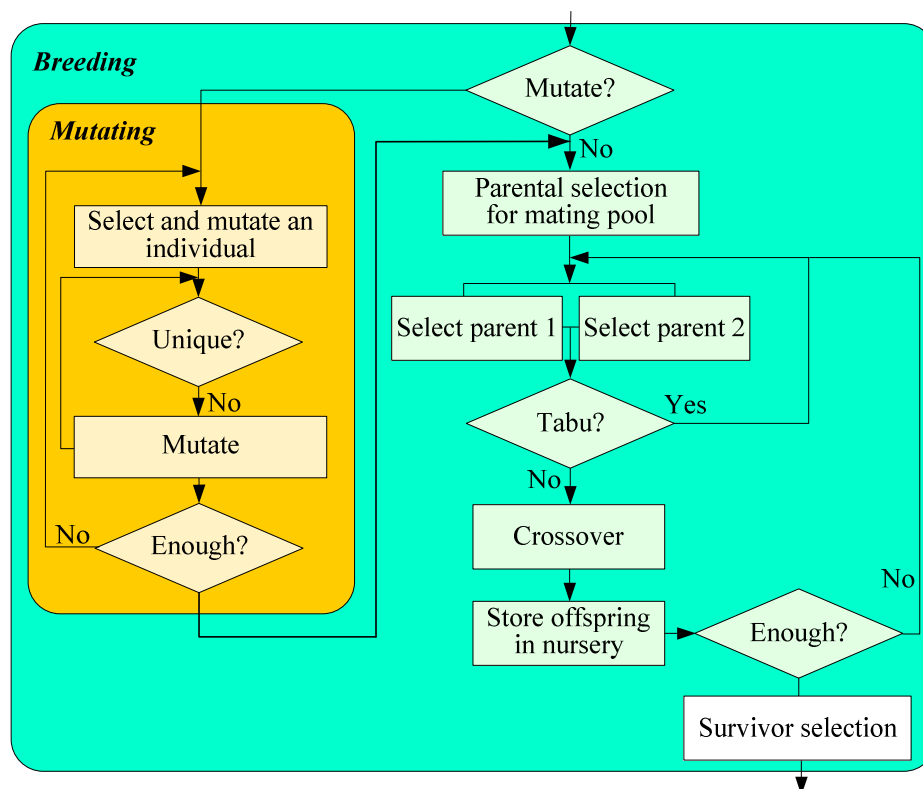

Figure 3.22 Reproduction phase processes

Parental selection is performed right after the mutation procedure is accomplished. The parents are first selected into the mating pool by employing the tournament selection method. Two parents are then selected randomly from the mating pool and tested for their legitimacy to mate. When the partnership is approved, the two parents are allowed to mate (*crossover*) and produce two offspring (Figure 3.21). The offspring are then stored in a nursery for temporary day care. They are subsequently filtered through the next selection process to enter the population.

#### 3.5.4.4 Parallel model

As mentioned before, apart from the hybridisation of the GA model to incorporate memory (i.e. *tabu list*), the model utilises the parallel algorithm approach. In this case, the population is divided into a number of islands (see Figure 3.23), where the heuristic search model is run independently on every island simultaneously. Individual migrations from one island to another will occur when there is a danger that a particular kingdom will be trapped in a premature convergence.

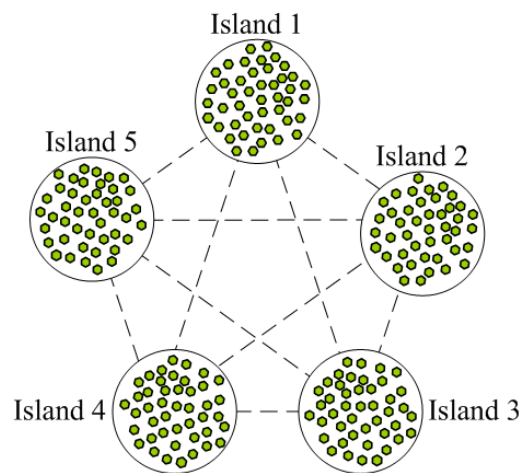

Figure 3.23 Five islands with a set of population in every island

In the assessment phase, the potential of the population's future is decided. If there is an indication that the population will not grow at all, then an individual from another population is invited to switch with a randomly selected individual and as a consequence becomes a permanent resident to mate with existing members of the population.

### 3.6 Model Assessment

Section 3.5 was primarily dedicated to discuss the development of the *TuGAs* prototype model. In this section, an assessment of the suitability of the overall EA model for application to the problem at hand is made. This assessment is conducted by examining advantages and disadvantages of the approach.

The key advantage of optimisation models based on EA is their ability to search for the “optimum” solution to the problem at hand. Nevertheless, the EA model has a flaw (sometimes seen as an advantage): it performs the search akin to a “blind watch

maker”. Zitzler *et al.* (2003) state that EA models do not guarantee the ability to identify optimal trade-offs, but only try to find a good approximation. In some cases this is not even the case (see Figure 3.24).

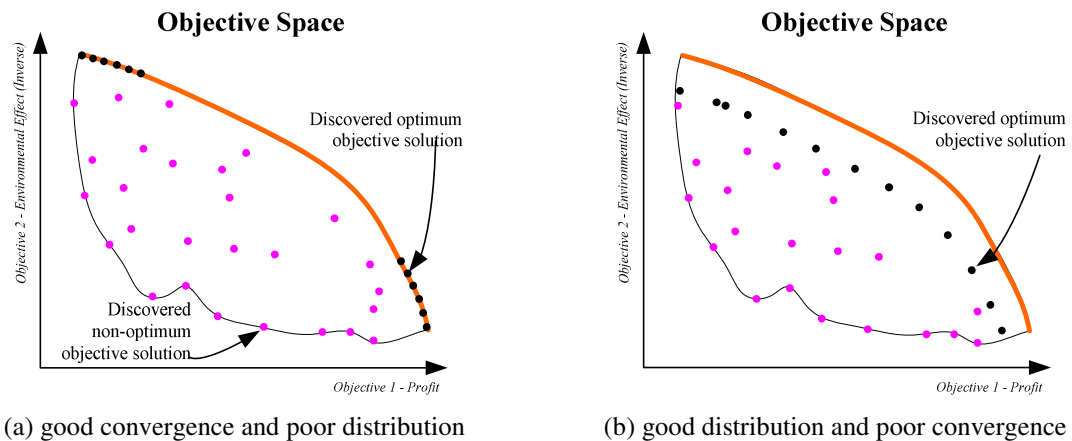

Figure 3.24 Multiple Objective solution space for a problem discovered by using two different models (Bladt 2002)

Figure 3.8 showed an example of an ideal result for a multiple objective problem, while Figure 3.24 shows two different cases where in each case a heuristic search model is applied to discover the optimum solution. In Figure 3.24 (a), the model employed has a good convergence characteristic, but it applied a poor trial input distribution; whereas in (b) the heuristic search model applied is able to discover a good population distribution, though it fails to deliver a good convergence model.

In a sense, EA models do not realise what they are attempting to find, in a way they blindly take any solution they can discover randomly. This is how the natural evolution works in the real world. Nevertheless, one needs to consider that if an optimum solution is sought, then all possible solutions need to be found in order to ensure that the final solution is the “best”. Otherwise, the whole practice of trying to find the “optimum” solution becomes a waste of time. When an EA model finds an “optimum” solution, there is no proof that the solution is actually the optimum. It is only an “optimum” compared to all the previous candidate solutions.

Furthermore, a key requirement of EA models is that of suitable parameter settings. The solution given by an EA model is very sensitive to these parameter settings (see Section 3.4.1). Slight changes to the settings can lead to significantly different

solutions. Appropriate parameter settings are often only obtained after significant trial and error. A trained user may be experienced enough to recognise possible suitable parameter settings with only a few trials, but for inexperienced users this will be a very fraught procedure. Self-adaptive approaches have been invented to overcome these problems, but there are still many factors that need to be resolved and developed.

EA models are not always problematic. They possess a number of positive attributes that raise them above other modelling approaches. For instance, EA models are capable of converging rapidly towards the “promising” peak. Also, because they are based on a set of solutions (population) they are able to perform computations faster than other methods.

However, a search model will be ineffective if it is not able to determine whether the solution found is “optimum”. As such, it was concluded that the prototype model for searching the optimal solution on a whole-farm basis that uses Evolutionary Algorithms will not be further developed in this research.

### **3.7 Chapter Summary**

This chapter extensively examines evolutionary methods such as Genetic Algorithms to act as a suitable search algorithm in a land-use or farm management decision-making model. The use of different Evolutionary Algorithms (EAs) as optimisation methods is discussed. The most suitable EA method is found to be the combination between two different approaches, i.e. Genetic Algorithm and Tabu Search. Genetic Algorithms were selected for their power to hunt for the best solution, while Tabu Search was selected for its memory characteristics, which enable recognition of earlier explored solutions and prevent it from taking the path that it took previously. As such a search prototype, called the *TuGAs* model, was developed.

The early assessment of EA models in this research suggested that they might have some ability in modelling the farm land-use decision-making process. This decision was supported by some successful applications of EA to land-use planning; see Matthews (2001) and Ducheyne (2003) for examples.

However, as noted in Section 3.6, after further exploration in this research it was found that EA models have a number of problems. In many cases, EA models are not always able to identify optimal trade-offs, but only try to find a good approximation (and in some of the cases this is not even the case). In addition, an EA model is very sensitive towards the initial parameter settings (see Section 3.4.1) and there is a need to establish suitable parameter settings for each different occasion. As such, the model needs a well-trained user to recognise possible suitable parameter settings that are suitable for the problem space being investigated. The limitations of the EA model were assessed to be significant enough to cease further development of the EA prototype and a refocusing of the research on exhaustive search techniques (see Chapter 4).

## CHAPTER 4

### METHODOLOGY

This chapter describes the methodology applied in the development of the Land-use Decision Support System, *MOLup* - Multiple Objective Land-use planning. *MOLup* was developed with the purpose of searching the optimum combinatorial set for the management of paddocks in a whole-farm mode. The optimisation is a trade-off between two major objectives: maximising the whole-farm profit, as well as, minimising the environmental effect associated with the land-use in each paddock on a whole-farm basis.

In Chapter 3, the use of an Evolutionary Algorithm (EA) was proposed. However, it was found that the main problem encountered by this approach is that EA is an incomplete search method, with a possibility that not all solutions are located and evaluated. Other disadvantages of EA approaches can be read in Section 3.6. Therefore, a decision was made to adopt an exhaustive search approach for implementing *MOLup*. This chapter discusses the development of *MOLup*.

#### 4.1 Overview of the Research Approach

As mentioned in previous chapters, multiple objective approaches have been grouped into four categories (Section 2.6.1) based on their preference articulation method: *Never*, *á Priori*, *Progressive* and *á Posteriori* articulation. In Section 2.2, it was concluded that *á Posteriori* approaches are a more flexible alternative for multiple objective optimisation problems.

The development of the *MOLup* system is described in this chapter based on an *á Posteriori* approach, which employs a *Search* and *Select* technique. This method attempts to ensure that all possible suitable solutions are searched prior to the selection of the optimum solution. A summary of the model is shown in Figure 4.1.

The first stage of *MOLup* is to initialise parameters (Section 4.2) based on the options set by the user. This includes the paddock constraints, marketing possibilities

and other primary parameters. In the input phase (Section 4.3), land-use management, predicted weather and predicted market price for the agricultural product are employed to evaluate the returns and gross margin of a particular crop under the paddock constraints (Figure 4.1).

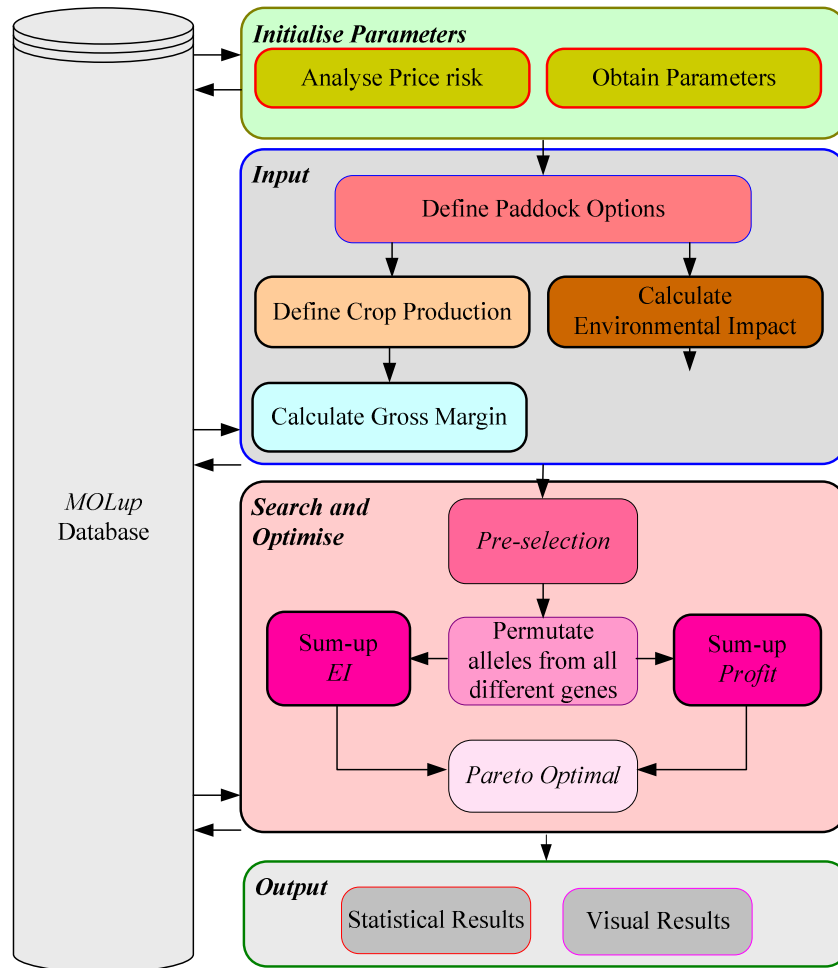

Figure 4.1 MOLup stages

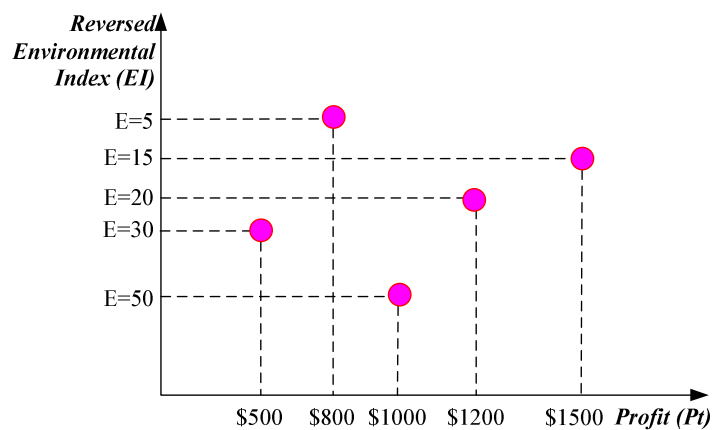

Figure 4.2 Trade-off: profit and environmental impact



The search and optimise phase requires a suitable search and select technique to locate feasible optimal solutions. Firstly, an exhaustive search method is used to search for all possible solutions. After an exhaustive search, the *Pareto Optimal* (Section 4.4.3) is employed to determine superior solutions based on competing trade-offs between the two different objectives: Profit and Environmental Impact (Figure 4.2, see Section 2.4.1 for details). The results are then presented in a format easy to understand and follow in the output phase (Section 4.5).

The terminology of population, chromosome, gene and alleles proposed for Evolutionary Algorithm Search Prototype in Section 3.3.1 will continue to be applied in this chapter (see Figure 4.3).

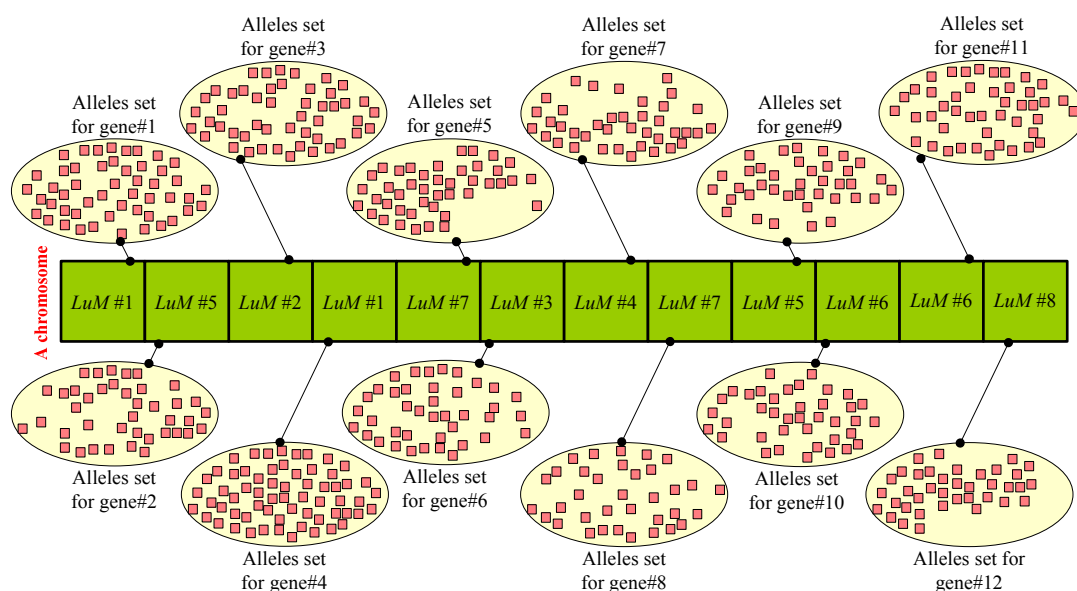

Figure 4.3 Each gene within a chromosome has a set selection of alleles

A gene represents a paddock on a farm, while an allele represents an appropriate land-use management option for that paddock (i.e. a gene) (Figure 4.3). A population consists of a set of chromosomes (i.e. whole-farm land-use management-*WLuM*) and a chromosome is made up of a set of genes with a set of alleles as shown in Figure 4.3 (see Definition 3.1- Definition 3.3). Each gene has a decision space, which corresponds to a trade-off between the resulting *Gross Margin (per unit)* and the *Environmental Impact* within an objective space (see Figure 4.4). Likewise, the complete set of chromosomes has a decision space, which corresponds to trade-offs between whole-farm *Profit* and *Environmental Impact* within an objective space.

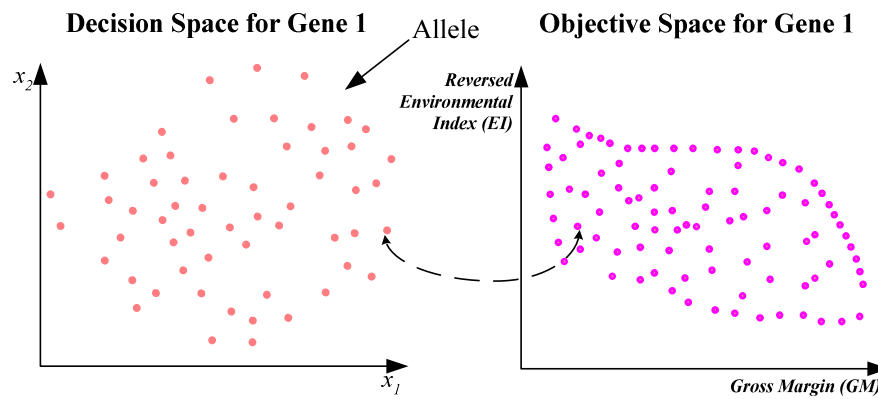

Figure 4.4 Decision space and objective space for genes; A variable  $x$  represents one land-use management element (i.e. only two elements are shown)

Furthermore, it needs to be noted that there are a number of terms, which need to be clarified to avoid confusion: *gross income*, *unit gross margin*, *product gross margin* and *profit* (Figure 4.5). In this thesis, the term *gross income* indicates the possible financial return from crop production from a paddock attributed to the land-use management treatment applied to that paddock. The *gross margin (unit)* indicates the gross income per unit of a paddock output less the variable cost associated with producing the crop. The *gross margin (product)* is the *total gross income* of a product obtained from yield production of the product less the total variable costs used to produce the product (Figure 4.5). However, *profit* signifies the total profit of all crop products generated within the whole-farm, based on the land-use and management that has been applied. This is calculated as the total summation of *gross margins* for all crop *products* less whole-farm fixed costs (see Figure 4.5).

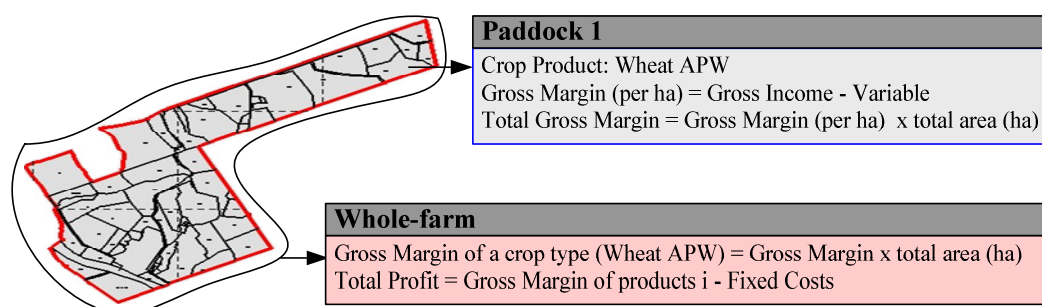

Figure 4.5 *Gross income*, *gross margin (unit and enterprise)*, and *profit*

## 4.2 Initialise Parameters

*MOLup* is a decision support tool which assists users in their farming decisions. However, it constantly requires up-to-date information as well as user decisions to

generate effective information. This information includes the condition of the paddock, paddock constraints, such as historical land-use practices, marketing decisions and constraints on sowing dates. Some of which is stored in existing recording systems and some require direct decision-maker input.

In the *MOLup* model there are a number of parameters, which need to be set by the decision-maker. These parameters include (Figure 4.6):

1. Maximum number of land-use management options per paddock, both contracted and non-contracted crop products (see Section 4.4.1.2). The default value is set to ten per paddock for crop types that produce non-contracted products and five per paddock for crop types that produce contracted crop products. *MOLup* sets contracted crop products as part of the constraint by ensuring the whole-farm production to be able to cover the required (contracted) amount of the crop produced;
2. Whether to apply Pareto Optimisation (default) to optimise the paddock land-use management selection (see Section 4.4.1.2);
3. The  $n$  number of iterations in Monte Carlo simulations (see Section 4.3.3 for further details). The default value given for this is  $n = 1000$  iterations;
4. The threshold  $p$ -value to be used for selecting the most probable crop products (see Section 4.4.1.2). The default value for this is  $p$ -value = 0.5.

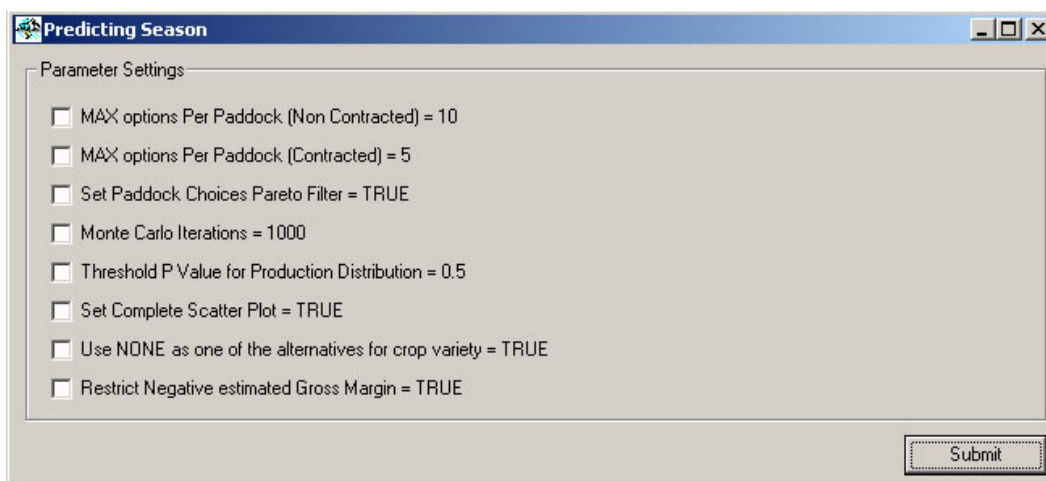

Figure 4.6 Setting *MOLup* Parameters

In addition, the user is asked to input marketing strategy decisions for each crop type. In the preliminary session, *MOLup* estimates the spot cash price for each crop

product price by utilising historical data (see Section 4.3.5 for further details), thus giving the user a preliminary view of the historical market prices. In such a case, the user is able to make initial marketing decisions on their products, such as whether or not to take out a contract for a particular crop based on historical prices (Figure 4.7).

Market Assessment		Estimated Spot Price		Current Contract Price
<b>Canola</b>				
<input checked="" type="checkbox"/>	Canola	366.81	44.01	<input type="checkbox"/> 337
<b>Barley</b>				
<input checked="" type="checkbox"/>	Malt	172.14	15.17	<input type="checkbox"/> 208
<input checked="" type="checkbox"/>	Feed Barley	138.36	13.38	<input type="checkbox"/> 177
<b>Lupins</b>				
<input checked="" type="checkbox"/>	Lupins	157.44	6.27	<input type="checkbox"/> 175
<b>Wheat</b>				
<input checked="" type="checkbox"/>	APH	186.27	10.34	<input type="checkbox"/> 226
<input checked="" type="checkbox"/>	AH	185.37	10.65	<input type="checkbox"/> 202
<input checked="" type="checkbox"/>	APW	187.50	9.25	<input type="checkbox"/> 188
<input checked="" type="checkbox"/>	ASW	234.09	13.16	<input type="checkbox"/> 169
<input checked="" type="checkbox"/>	ASWN	232.03	16.67	<input type="checkbox"/> 200

Number	Product	Lock Price	Lock Amount	Lock Percent	Lock Date
1	Canola	337.00	50.00	-	3/02/2006

Figure 4.7 Marketing decisions

### 4.3 The Input Phase - Creating the Database

The main role of the input phase is to determine all possible land-use options and management strategies for each paddock. Each paddock within a farm is treated as unique and individual. They are assumed to have unique attributes, conditions and constraints, thereby requiring unique paddock land management practices. The general process of the input phase is for every paddock to be initiated with a set of suitable paddock land-use management options (see Section 4.3.1). Once all possible alleles are collected, each one will then be evaluated for possible crop production (based on the current weather forecast), *gross margin* (based on the current forecast of crop product prices) and the possible *environmental impact* (based on the application of the land-use management option) (see Section 4.3.2) (Figure 4.8).

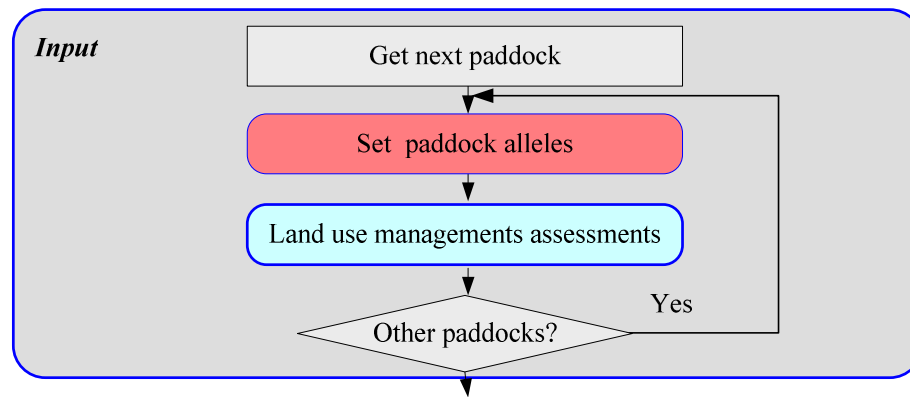

Figure 4.8 Input phase processes

The input phase employs three simulators (Figure 4.9). The first predicts crop production based on the selected paddock management and projected weather expectation (see Section 4.3.4.2), the second predicts the spot cash price for the crop (see Section 4.3.5), and the third performs an environmental impact assessment (see Section 4.3.6).

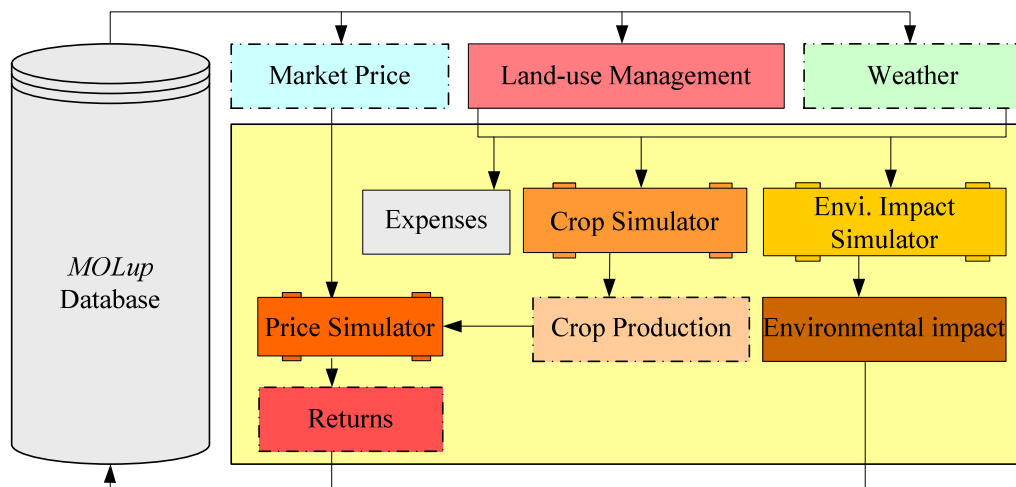

Figure 4.9 Data flow in input phase

#### 4.3.1 Paddock land management

Paddock level management options consist of: crop type, sowing date and the levels and timing of fertiliser and sprays. Rotational constraints can also be accounted for at this stage. However, the current prototype will not incorporate physical crop rotation constraints, instead it will only account for crop rotation incorporated in the crop production simulator (see Section 4.3.4). Each of the management elements has different choices; with all choices being mutually exclusive. For instance, there are a number of different crop types that can be sown in the paddock at different sowing

dates. Each management option has a slight, but distinct, difference with the next one. The formation of the management recommendation for a paddock is done by permutating the choice given by each element within the management options (Figure 4.10). Such permutation may create an explosive number of choices. For example, in Figure 4.10, there are five crop type choices, namely: Wheat Carnamah, Wheat Calingari, Barley Stirling, Canola 402 CL, and Lupins Merritt. The combination of different alternatives from each option will form 1,920 unique management options (alleles). Additionally, the significance of a management option can be weighed based on its expected gross margin and the environmental impact of the allele (see Section 4.3.2).

#### Total combinations creates 1920 alleles

Crop Type (varieties)	Sowing Date	Fertiliser (sowing)	Fertiliser (4th Week)	Fertiliser (Late)	Spray
Wheat Aroona	31 March	None	None	None	None
Wheat Baroot	07 April	30	30	30	
Barley Stirling	14 April	50	50	50	
Canola Gem	21 April	100	100	100	
Lupins Gungur	28 April				
	05 May				

5   X   6   X   4   X   4   X   4   X   1

#### One allele combination

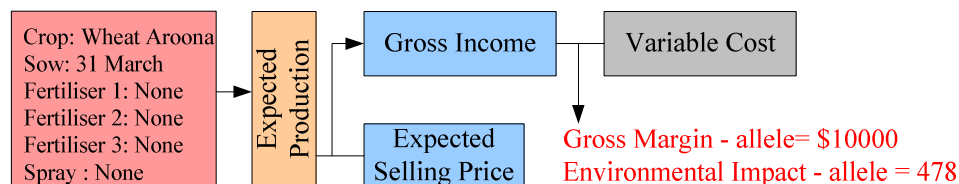

Figure 4.10 Different land-use management options (i.e. allele) for a paddock (i.e. gene)

#### 4.3.2 Land-use management assessment

The land-use management assessment phase is designed to determine the worth of land-use management options for a paddock based on the generated gross margin and environmental impact. Paddock attributes (i.e. soil attributes and historical activities) are used to constrain the suitable set of management options (i.e. crop type, fertilising, spraying and sowing date) and these are then assessed on their gross margin and environmental impact (Figure 4.11).

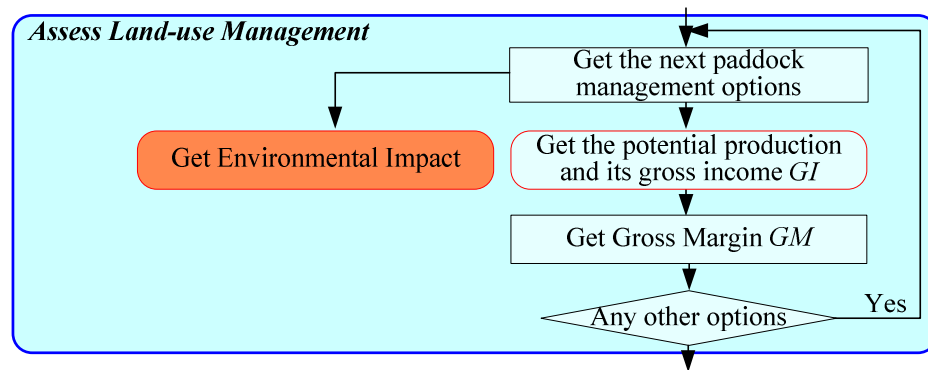

Figure 4.11 Gross margin from a land-use management on a paddock

Initially, the management and weather information are processed to determine potential crop production and quality (Figure 4.12 and see Section 4.3.4.2) and then matched with the simulated product price and marginal cost information to generate gross margin (see Figure 4.13).

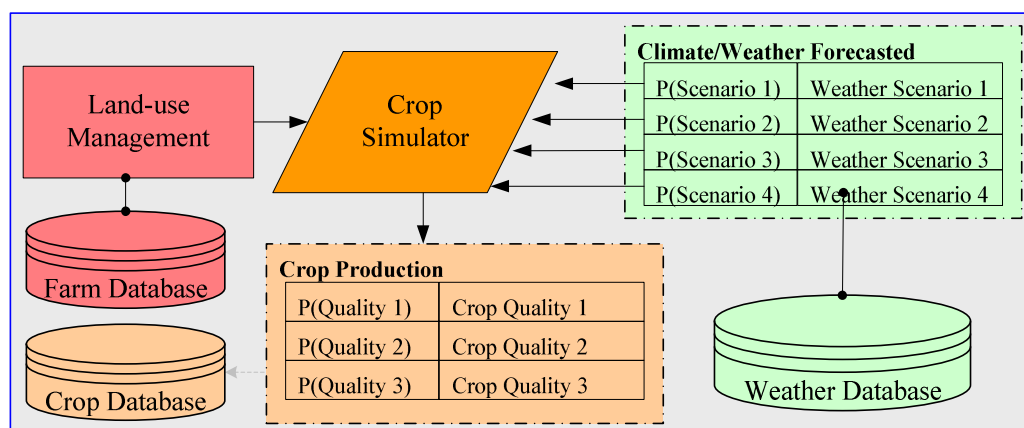

Figure 4.12 An example of climate forecasting and crop production estimation

Two selling options are allowed: contract or cash trading. The contract trading is a fixed price established in the contract, while the cash trading is based on the value of the crop in the spot markets (see Section 4.3.5). The price in the spot market is generated by a Monte Carlo simulation process (Figure 4.13) (see Section 2.7 for an introduction and Section 4.3.3 for its procedures).

The Monte Carlo simulation process generates a distributed set of gross margin values, which are then used as part of the heuristic approach discussed in Section 4.4.1.2. The gross margin distribution is then used to generate the expected gross margin value (Figure 4.13). Further details are discussed in Section 4.3.3.

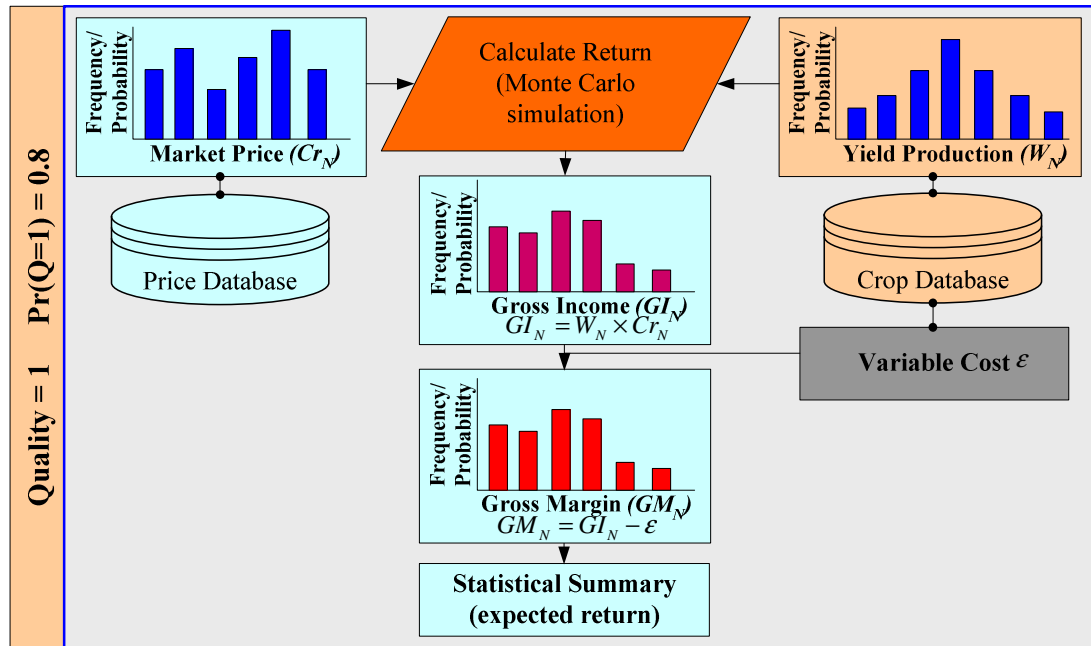

Figure 4.13 A sample result of Monte Carlo process based on the spot market trading (see Section 4.3.3 for Monte Carlo procedure)

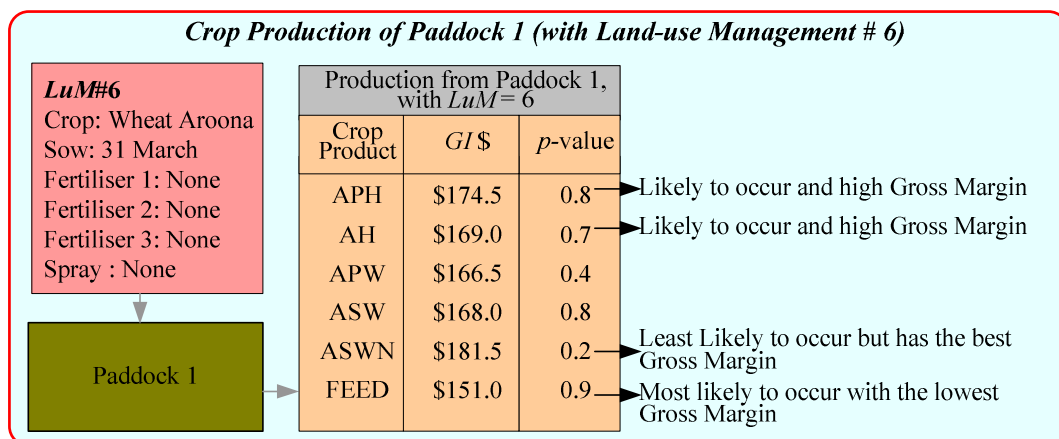

Figure 4.14 Sample of crop production of a paddock based on a specified land-use management option

In addition, every management option for a paddock provides a set of possible crop products (i.e. crop grades), and the likelihood of every crop product occurring based on a management option is not always the same (Figure 4.14) (see Section 4.3.4.2 for details). At times, one crop product is more likely to occur than the other, depending on the set of input variables and the resulting crop simulation. Accordingly, *MOLup* utilises a selection process to constrain the most probable crop product to occur, based on each land-use management given by utilising the occurrence probability of the crop product (i.e. *p*-value). However, at the same time the crop price is also used as part of the selection process.



The approach undertaken in selecting the most probable crop product, due to a management option, is based on the initial input criteria given by the decision-maker. The inputted threshold  $p$ -value is utilised to limit the most acceptable group of crop products from the whole set of the land-use management results. The pre-selected crop products are then assessed for their *gross income* value. The crop product with the best *gross income* is then used as the most probable crop product (Figure 4.15).

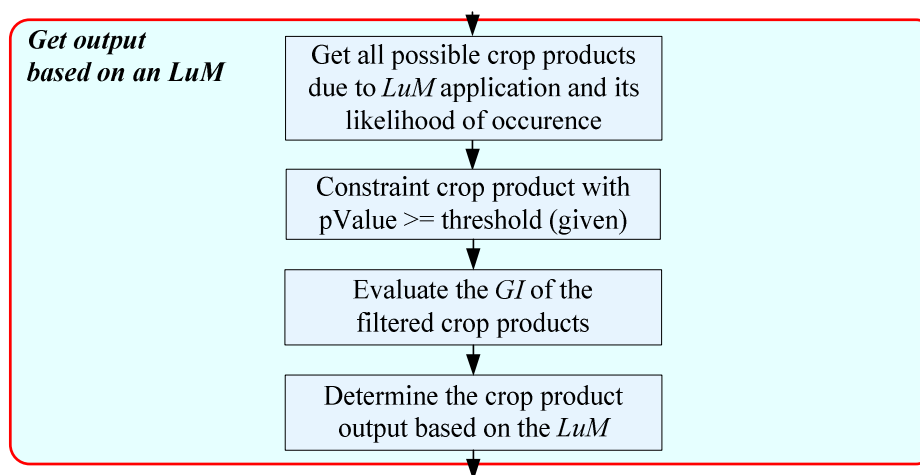

Figure 4.15 Determining the most probable crop product

The threshold  $p$ -value provided by the decision-maker is the lowest probability of a crop yield they are prepared to accept. The choice of this  $p$ -value is crucial as it limits the decision space for land-use and management options (see Figure 4.16).

**Crop Production of Paddock 1 (with Land-use Management # 6)**

Productions of Paddock 1, with $LuM=6$			
Crop Product	$p$ -value	Return \$	
FEED	0.9	\$151.0	Threshold $p$ -value = 0.9
APH	0.8	\$174.5	
ASW	0.8	\$168.0	Threshold $p$ -value = 0.8
AH	0.7	\$169.0	
APW	0.4	\$166.5	Threshold $p$ -value = 0.3
ASWN	0.2	\$181.5	

Figure 4.16 Sample of selecting crop products using threshold  $p$ -value

### 4.3.3 Modelling uncertainty by using Monte Carlo

Farm management operates in a dynamic environment impacted on by the factors, such as weather and the crop product market. A farm decision support system needs to be able to model the uncertainties. In Section 2.8.2, it was determined that Monte Carlo is the most suitable method to incorporate the uncertainty associated with farm production systems into the *MOLup* model.

Monte Carlo simulation is an approach for incorporating the uncertainty found in the physical system into the analytical system. It employs a statistical simulation method to obtain a probabilistic solution to the modelled decision-making environment (U.S. EPA 1997). Figure 4.17 illustrates the general idea of the Monte Carlo simulation processes, where numerous random number  $x$  values between zero and one are used to obtain the simulated distribution values  $f(x)$  of the weather.

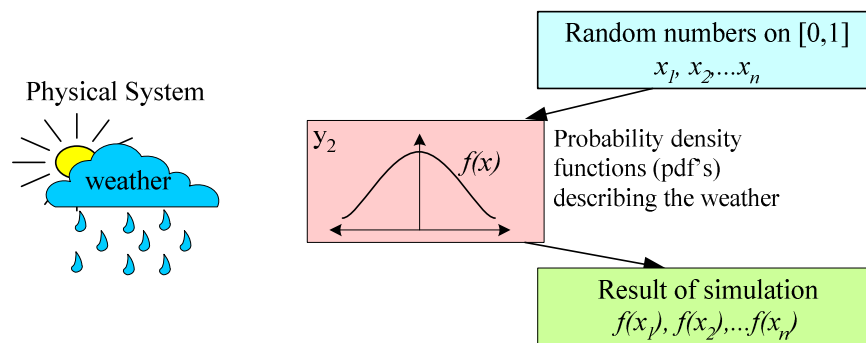

Figure 4.17 Monte Carlo simulation of the physical system weather

The main requirement of the Monte Carlo model is that the physical system needs to be illustrated by probability density functions (PDF). Typically, PDF models can take on a variety of shapes. Some of the most common models are: Normal, Weibull, Beta, Exponential, Uniform and Triangular distribution. Nevertheless, the PDFs of a system do not always fit with the conventional models, instead, a custom-made model can be generated to fit the system.

The fundamental of Monte Carlo analysis is simple: it simulates the processes of a system iteratively to generate a large number of possible events. In a deterministic model, a single value for each input variable of the model will generate a single output of the model. In Monte Carlo, the process is performed for  $n$  iterations. Within

a model, each input parameter with an uncertain element is assigned a known distribution (Figure 4.18). The output from the model is evaluated  $n$  number of times. For each iteration, a value is selected from the PDFs of each input parameter by using the randomly generated  $x$  values. The simulated results from the  $n$  iterations will then form a distribution of the model output (Pseudo-code 4.1).

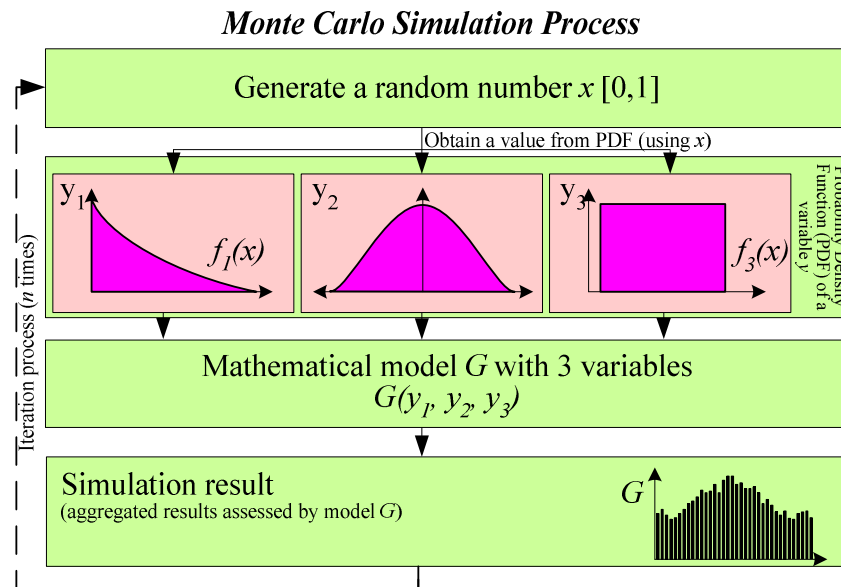

Figure 4.18 Monte Carlo simulation of a mathematical model  $G$  (see Pseudo-code 4.1)

```

Perform_MonteCarlo_Simulation()
FOR all iteration  $n$ 
  FOR all input  $i$ 
    IF input  $i$  has a distribution
      Call TheRandomNumber_Generator(lower_limit, upper_limit)
      Obtain the value for input  $i$ 
    ELSE
      Use the constant of input  $i$ 
  Evaluate Model  $G$ , employing all input variable obtained
  Store the result

```

Pseudo-code 4.1 A sample of performing Monte Carlo on a model  $G(x)$ , which has various numbers of input variables with uncertainty elements (Figure 4.18)

Although Monte Carlo is basically a simple process, problems can occur if care is not taken in selecting the following parameters:

- Probability distribution function (PDF) - It is crucial to obtain an appropriate PDF which best represents the system to ensure an accurate outcome;
- Random number generator - An efficient generator is required to obtain a representative distribution over the range from zero and one;

- The  $n$  number of iterations - An suitable number of iterations are required to represent the system effectively as well as reducing the bias and error. If the iteration number is too low, it may cause an insufficient exploration of the decision space; and if it is too high then it may take too much computation time without improving the solution;
- Sampling rule - An efficient sampling method from the PDF's is required, as a prescription to sample the PDF's;
- Variance reduction techniques - Appropriate variance reduction techniques are required to reduce the variance in the estimated solution.

The *probability distribution function* employed will be the distribution of all possible values, such as crop production distribution (see Section 4.3.4.1 - Section 4.3.4.3) and gross margin evaluation based on a crop product price forecast (see Section 4.3.2).

The result given by the Monte Carlo simulation may then be summarised by statistical measures, such as expected value and variance. The mean (expected value)  $E$  or  $\mu$  - and the variance  $V$  of discrete random variable  $g(x)$  are stated as the following:

$$E[g(x)] = \frac{\sum_i g(x_i)}{n}, \quad \text{where } i = 1, \dots, n \quad (4.1)$$

$$V[g(x)] = \frac{\sum_i (g(x_i) - E[g(x)])^2}{n} \quad (4.2)$$

When the data is a discrete random variable  $g(x)$  with probability function  $p$ , the expected value  $E$  and variance is stated as the following:

$$E[g(x)] = \sum_i p_i g(x_i) \quad (4.3)$$

$$V[g(x)] = \sum_i p_i (g(x_i) - E[g(x)])^2 \quad (4.4)$$

It needs to be noted that the estimation of the simulated probability distribution may have some limitations, such as over-simplified results and concealed extreme values.

The  $n$  number of iterations is a critical decision in obtaining an unbiased result. In general, bias can be written as the following (where  $\tilde{g}$  is the *mean parameter* of  $g$  and  $\hat{g}$  is the estimator of the *mean parameter* of  $g$ ):

$$bias = E(\hat{g}) - \tilde{g} \quad (4.5)$$

The magnitude of the small sample bias is approximated to be one over  $n$ , where  $n$  is the number of iterations. Therefore, to minimise the bias the number of  $n$  needs to be increased. Conversely, this becomes a problem in computation time required. A good balance is required to ensure the minimisation of the bias, as well as an acceptable computation time. The decision-maker is asked to state their preferred  $n$  number of iterations during the parameter initialisation stage (see Section 4.2).

A random number generator is usually employed to generate random variables  $U$  that are independent and uniformly distributed in the unit interval (i.e.  $a$  and  $b$ ) with the probability density as (Note: in standard format, the uniform distribution parameter  $a$  equals to zero while  $b$  equals to one):

$$f(u) = \begin{cases} \frac{1}{(b-a)} & , u \in [a, b] \\ 0 & , u \notin [a, b] \end{cases} \quad (4.6)$$

It needs to be noted that *MOLup* is using *rnd()* as the function for generating the random number. However, this method is not perfect but generates unbiased uniformly distributed random numbers. To resolve this problem, *MOLup* also employs *TheSeeder()*, which in turn employs *date()* and *time()* functionality to increase the randomisation performance (Pseudo-code 4.2).

```
TheSeeder()
  Get the date (day, month, year)
  Seed1 = f(day, month, year, rnd())
  Seed2 = f(Seed1, rnd())
  TheSeed = f(Seed2, time, day, month, year)

TheRandomNumber_Generator(lower_limit, upper_limit)
  Call TheSeeder()
  Normalise TheSeeder (ranged from the given lower and upper limit)
```

Pseudo-code 4.2 Random number generator with seeder

It was recognised that observing and resolving the most suitable parameter and variety is critical in employing Monte Carlo simulation effectively. Nevertheless, the scope in obtaining the suitable parameters and range of optimal variations is beyond the scope of this research. Subsequently, the Monte Carlo simulation employed is a

basic version. Further reading can be found at Kandaswamy (2001) and Weinzierl (2000).

#### 4.3.4 Crop production

Determining the crop yield is a key data element in *MOLup*. This is achieved through the use of a crop production simulator. There are a number of simulators that can be used to simulate crop yield production including SYN, PYCAL, APSIM and WA Wheat. WA Wheat was selected as the most suitable simulator for use in the *MOLup* model.

WA Wheat is a database produced by employing the simulation model widely adopted APSIM-NWheat model to estimate wheat production in Western Australia (Figure 4.19) (Fisher *et al.* 2001b). It allows the user to predict wheat crop production based on a particular combination of season and management options, and estimates associated environmental impacts, such as leakage of water and nitrogen (Scanlan *et al.* 2003).

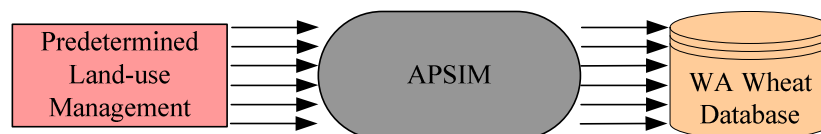

Figure 4.19 APSIM and WA Wheat

APSIM-Wheat is a wheat crop system simulation model within the APSIM-framework. It attempts to integrate aspects of soil water, nitrogen, crop residues, wheat crop development and growth. This is achieved by evaluating crop phenology, developed leaf area, and intercept light, determining dry matter due to weather, water, and water stress (Probert *et al.* 1995).

The APSIM model consists of a central interface engine that is linked to a series of plug-in/pull-out modules (Figure 4.20). It is capable of simulating more than 20 different crop types individually, as well as, the simultaneous simulation of multiple crops in intercropping systems (Wang *et al.* 2001) (Table 4.1).

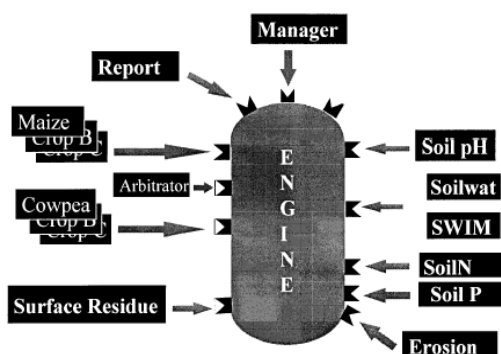

Figure 4.20 APSIM simulation framework, a central interface engine that connects individual crop and soil modules (Keating *et al.* 2003)

Table 4.1 Crop modules in APSIM and relevant references (Keating *et al.* 2003)

APSIM Module	Original Model	Reference
Barley		
Canola		Robertson <i>et al.</i> (1999)
Chickpea		Robertson <i>et al.</i> (2002)
Cotton	OZCOT	Hearn and Da Rosa (1985)
Cowpea	APSIM-cowpea	Adiku <i>et al.</i> (1993)
Hemp		Lisson <i>et al.</i> (2000d, a, b, c)
Faba bean		
Forest		Huth <i>et al.</i> (2001)
Maize	AUSIM-maize	Carberry and Abrecht (1991)
Lucerne		Robertson <i>et al.</i> (2001a), Probert <i>et al.</i> (1998)
Millet		van Oosterom <i>et al.</i> (2001c, a, b)
Mucuna		
Mungbean		Robertson <i>et al.</i> (2001a; 2001b)
Navy bean		
Pasture		
Peanut	QNUT	Robertson <i>et al.</i> (2001a)
Pigeon pea		Robertson <i>et al.</i> (2001a)
Sorghum	ASORG AUSIM-sorghum	Hammer and Muchow (1994), Muchow <i>et al.</i> (1994) Carberry and Abrecht (1991)
Soy bean		Robertson <i>et al.</i> (1999)
Sunflower	QSUN	Meinke <i>et al.</i> (1993), Chapman <i>et al.</i> (1993)
Wheat	Nwheat I_Wheat	Keating <i>et al.</i> (2001) Meinke <i>et al.</i> (1998b, a)
Stylo		
Sugarcane		Lisson <i>et al.</i> (2000e), Keating <i>et al.</i> (1999)
Weed		

Wang *et al.* (2001) stated that the crop module in APSIM uses the basic understanding that all crop species go through similar physiological principles to capture resources, such as solar radiation, soil water and nutrients, employing these resources to grow. Typically, the plant growth framework progresses through a number of phenological phases: a leaf canopy is produced, incident radiation is intercepted and absorbed energy is transformed into assimilates that are divided among plant components, including yield (Carberry 2001). The soil supplies the

resources, such as water and nutrients. This basic framework is the fundamental process of the quantitative analysis of crop growth (Carberry 2001). The major distinction between crops, is the parameters employed and the shapes of their response function.

A description of APSIM is beyond the scope of this thesis, so the discussion will focus on a description of the APSIM Wheat model used in this research. A full description on the model can be found in Wang *et al.* (2001) and the APSIM webpage [URL: <http://www.apsim.info/info>].

The APSIM-Wheat model has been validated in Western Australian environmental conditions; namely soil type and weather. The validation was performed by Asseng *et al.* (2002; 1998a; 1998b), while WA-Wheat database, a second product resulting from the model was compiled by Scanlan *et al.* (2003). The WA database has a user interface which allows analysis of specific combinations of land-use management. The output from the WA Wheat is provided in a range of formats, including: graphical, time series, differences, cumulative probabilities, box and whisker plots, frequency distributions and pie charts (Fisher *et al.* 2002).

Crop production (CP) is determined based on a number of physical and management factors, such as, soil type ( $S$ ), crop variety ( $V$ ), sowing date ( $D$ ), rotations ( $R$ ), fertiliser ( $F1, F2, F3$ ), initial soil water ( $W$ ) as follows:

$$CP_{LuM} = CP(S, V, D, R, F1, F2, F3, W) \quad (4.7)$$

As weather is the major driving variable, the model generates a yield for each physical and management factor for each discrete historical annual weather pattern since 1900 (see Figure 4.21). Data for Beverley was selected for use in the *MOLup* model, as it was the closest validated data set to the case study property but other dataset could be substituted to more closely represent the focus property.



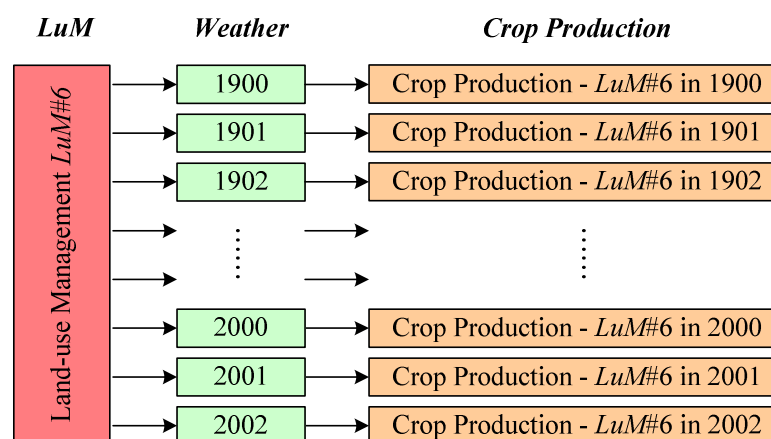

Figure 4.21 A sample of WA Wheat results based on one set of land-use management options

#### 4.3.4.1 Pre-processing crop production data

Weather is one of the significant factors which influences crop yield for a specific management regime at a particular location (Scanlan *et al.* 2003). To facilitate the crop production prediction based on the weather, the crop production simulated data are pre-processed into the crop production group based on the typical seasonal types. These data will then be adapted to forecast the crop production yield and its quality.

There have been a number of studies that have attempted to categorise season type based on rainfall so that farmers can optimise their seasonal cropping strategies. Sadras and Roget (2002) have used median April rainfall as a tool for rainfall forecasting in south-eastern Australia. Fisher *et al.* (2001a) break the season into eight season types based on the amount of summer rainfall (January till March) and early season rainfall (April till May) (see Table 4.2 for a sample of the classification threshold value). The crop production data are generated on a yearly basis and simulated based on the weather characteristics of the year. In effect, the classification of the year can be used to group crop production on the basis of season types.

The cut-off points shown in Table 4.2 are based on the mean rainfall in each of the three rainfall groupings for the Beverley Shire. The data are based on the average rainfall of six weather stations located in the Shire of Beverley between the periods 1900 until 2002 (see Table 4.3 for result).

Table 4.2 The classification of eight season types based on the Beverley Shire rainfall between 1900 - 2002 (see Table 4.3 for results)

Season Type	Total Rainfall (mm)			No Years
	Summer	Early Season	Annual	
1 (dry all year round)	<=42.32	<=80	<=431.61	29
2	<=42.32	>80	<=431.61	8
3	<=42.32	<=80	>431.61	12
4 (dry summer, wet annually)	<=42.32	>80	>431.61	17
5 (wet summer, dry annually)	>42.32	<=80	<=431.61	11
6	>42.32	>80	<=431.61	10
7	>42.32	<=80	>431.61	3
8 (wet all year round)	>42.32	>80	>431.61	12

Table 4.3 Allocation of individual years to season types based on Beverley rainfall

Season Type															
1		2		3		4		5		6		7		8	
29 Years		8 Years		12 Years		17 Years		11 Years		10 Years		3 Years		12 Years	
1901	1902	1913	1908	1900	1905	1922	1904	1933	1915						
1903	1906	1930	1911	1907	1909	1925	1916	1984	1923						
1912	1914	1936	1919	1910	1917	1927	1918	1989	1926						
1920	1924	1945	1937	1921	1931	1959	1935		1934						
1928	1929	1958	1947	1932	1941	1971	1938		1939						
1940	1944	1973	1956	1942	1946	1978	1943		1951						
1948	1949	1983	1962	1953	1964	1979	1961		1955						
1950	1952	1996	1967	1965	1974	1982	1968		1960						
1954	1957		1970	1995		1986	1990		1963						
1966	1969		1987			1997	1992		1976						
1972	1975		1988			2000			1981						
1977	1980		1994						1999						
1985	1991														
1993	1998														
2001															

This classification has been used to aggregate crop production into eight groups with associated crop production distribution (Figure 4.22). Depending on the way the cropping year presents itself, each of the season types will have a probability of occurring within the current production year.

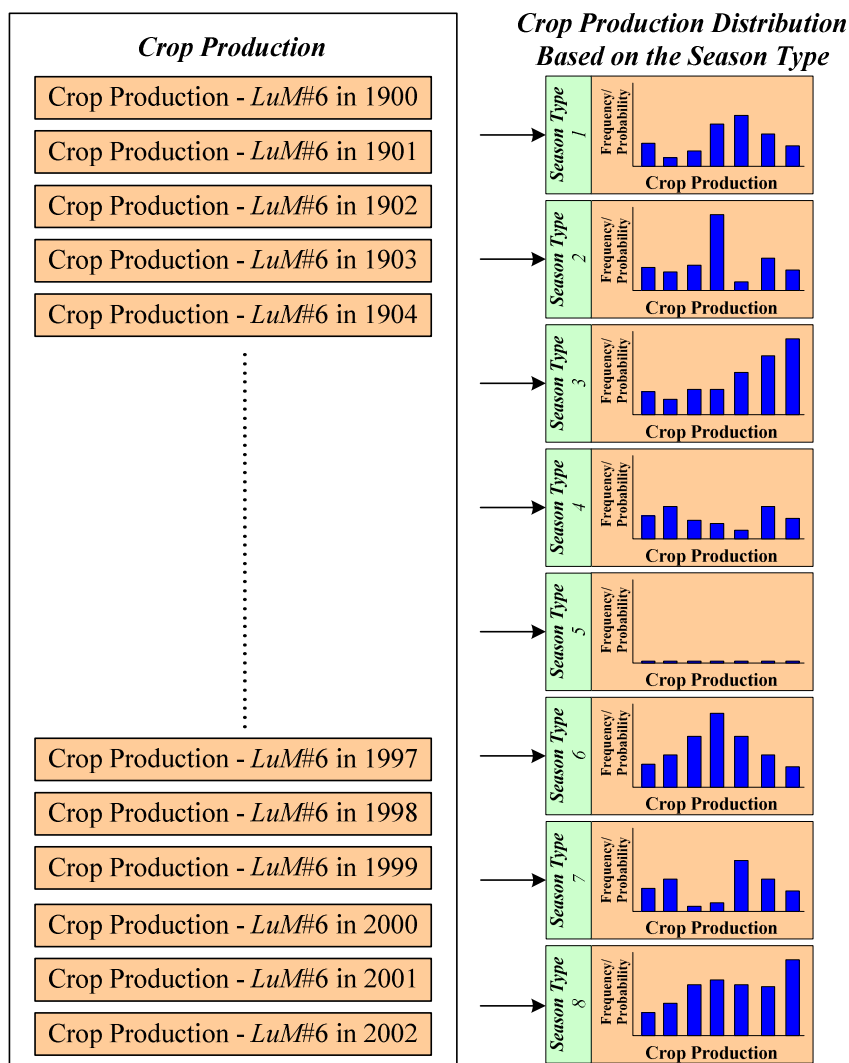

Figure 4.22 Sample crop production distribution of a land-use management option based on season type (see Table 4.3 for classification)

#### 4.3.4.2 Adapting the crop production based on the year forecast

There is a need to adapt the crop production/weather data in WA Wheat to represent the decision making process taking place on farms. In this case, the crop production adaptation process generates a representative crop production based on the probable season type for a particular year. In this case, Bayesian theory is used, where given prior probabilities of season types are applied to determine the probable crop production.

At the beginning of the year, future weather events are unknown and there is a wide range of weather event possibilities. However as time moves on, weather data, particularly rainfall data, becomes available and this information can be utilised to refine the probability of future rainfall events occurring and related crop production.

Farmers frequently predict the occurrence of a season using instinct, knowledge and experience. Based on their expert knowledge, they predict the chance of a season occurring. *MOLup* tackles prediction in the same manner, using probability/possibility values to indicate the chance of a season type occurring (see Section 4.3.4.3). Since the classes of crop production distribution are grouped based on the season type, they can also be attached to a probability/belief value, thus indicating the chance of that particular class of crop production distribution occurring based on the corresponding season.

The “representative” crop production distribution is aggregated from the eight possible crop production distributions using probability or possibility values. The probability or possibility value of the season type is used as the chance that a typical season type will occur, which in turn signifies the chance that crop production based on that particular season type will occur (see Pseudo-code 4.3 for detail processes).

```

Obtain_CropProduction()
  Call obtain_SeasonProbability() or obtain_SeasonPossibility()
  FOR all distribution location (crop production bag)
    Select crop production from aggregation plate
  Call Arrange_CropProductionQuality()

Categorise_CropProducts_Quality()
  FOR all crop product type i
    Get crop product attribute
    Find all crop production which has the attribute
    Save all crop production found as crop product i distribution

```

Pseudo-code 4.3 Obtaining the crop production distribution based on the probability or possibility value (see Section 4.3.4.3)

Monte Carlo simulation is then used to incorporate the uncertainty of the crop production by iteratively ( $n$  number of times) and randomly picking the possible crop production from the aggregated set in order to form a representative distribution of crop production. The quality of crop production (see Table 4.4 for example) will then be used to categorise the crop production into groups of different crop products. See Figure 4.23 for a working example of the process.

Table 4.4 Wheat products specifications (AWB 2005; ProFarmer 2005)

Crop	Product Name	Specifications		
		Protein	Screenings	Moisture
Wheat	APH (Australian Prime Hard)	>13%	5%	12.5%
Wheat	AH (Australian Hard)	11.5%-12.99%	5%	12.5%
Wheat	APW (AWB Premium White)	>10%	5%	12.5%
Wheat	ASW (AWB Standard White)	No Limit	5%	12.5%
Wheat	ASWN (Australian Standard White Noodle)	9.5%-11.5%	5%	12.5%
Wheat	FEED	No Limit	No Limit	No Limit

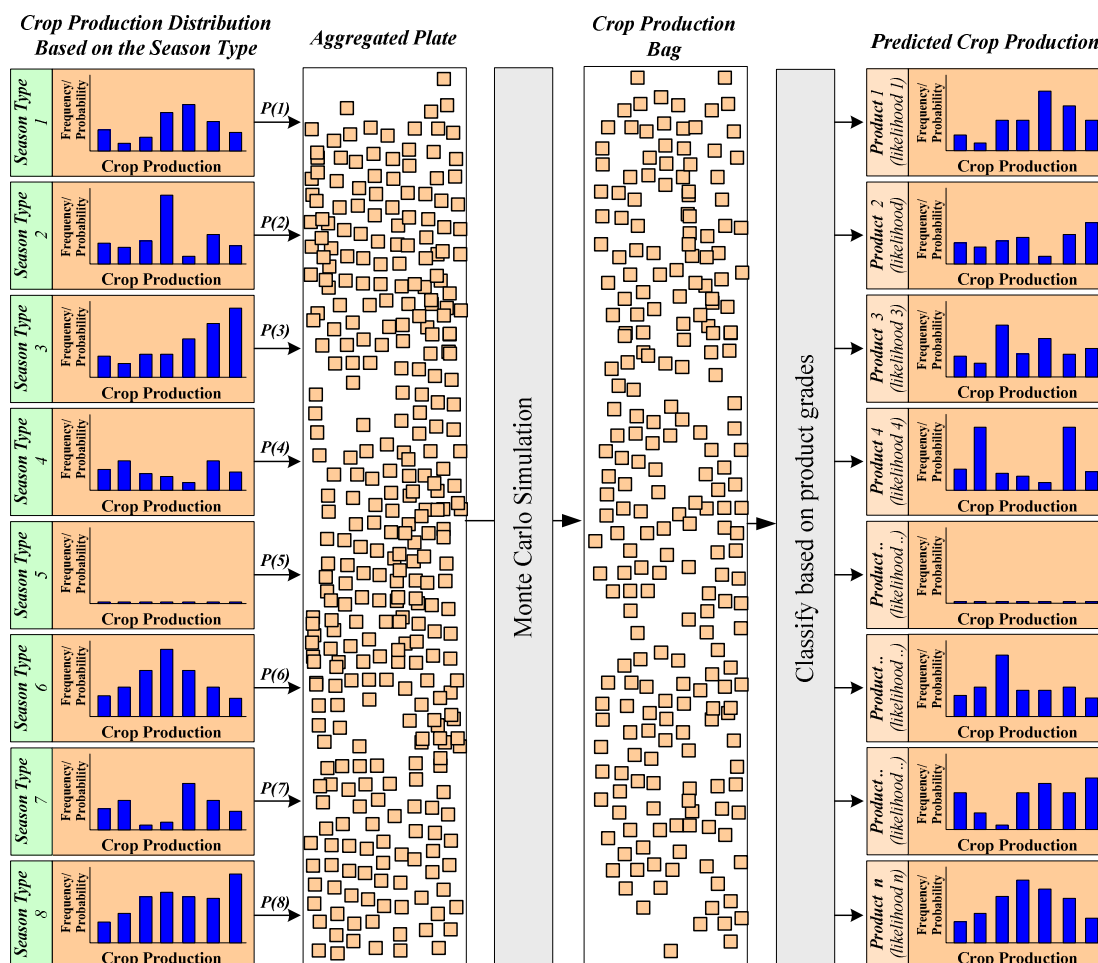

Figure 4.23 Crop production amassing based on the probability of season type

Wheat quality classification is complex and involves four separate factors: protein content, grain hardness, flour dough strength and milling quality (Dewan 1988). As WA Wheat only provides protein level, for the purpose of this thesis the classification of wheat grades will be based on protein level only.

Suitable production/quality simulator models were not available for the other crops of interest - canola, lupins and barley. There is therefore, a need to develop

appropriate yield estimates for these crops. Research by Fisher (2005) has indicated that canola, lupins and barley yield are correlated to wheat production as follows:

$$\text{Canola} = 0.6 * \text{Wheat} \quad (4.8)$$

$$\text{Lupins} = 0.5 * \text{Wheat} \quad (4.9)$$

$$\text{Barley} = 1 * \text{Wheat} \quad (4.10)$$

While this gives a crop yield, it is impossible to directly derive quality parameters in the same way. This means that for these three crops one quality is assumed.

#### 4.3.4.3 Predictions based on prior probabilities

The adaptation of the crop production process adopts the Bayesian prior probability approach and therefore, the application of appropriate  $p$ -values into predicting weather based on the season type is an important process. In principle, the prior probability can be calculated based on a given data set. This process is called data-driven. Nonetheless, generally the data is not comprehensive enough to be used for the estimation. Therefore these decisions can also be obtained based on subjective probability estimates provided by experts (i.e. expert knowledge); thus known as knowledge based (see Figure 4.24).

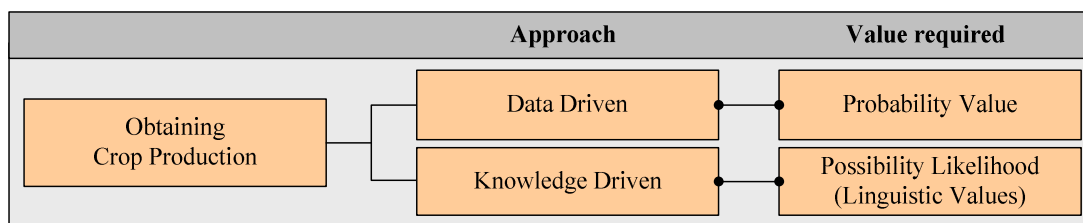

Figure 4.24 Methods to obtain crop production distribution based on season types

##### 4.3.4.3.1 Data driven approaches

The data driven model can be used for estimating crop production based on possible season types. Each of the season types requires a probability value representing the chance of it occurring (Figure 4.25). The data-driven model performs the estimation of the probability values by employing a statistical method to process training data (Wang *et al.* 2002; Bonham-Carter 1996).

The data driven approach has been integrated in *MOLup* to obtain the potential crop production distribution. It provides a set of conditional probabilities which illustrate the prospect of a season occurring given the current rainfall data (Figure 4.25). It is

used to constrain the sample area with a strengthening of the prediction, as more information (i.e. summer, early season and annual rainfall) is fed into the system.

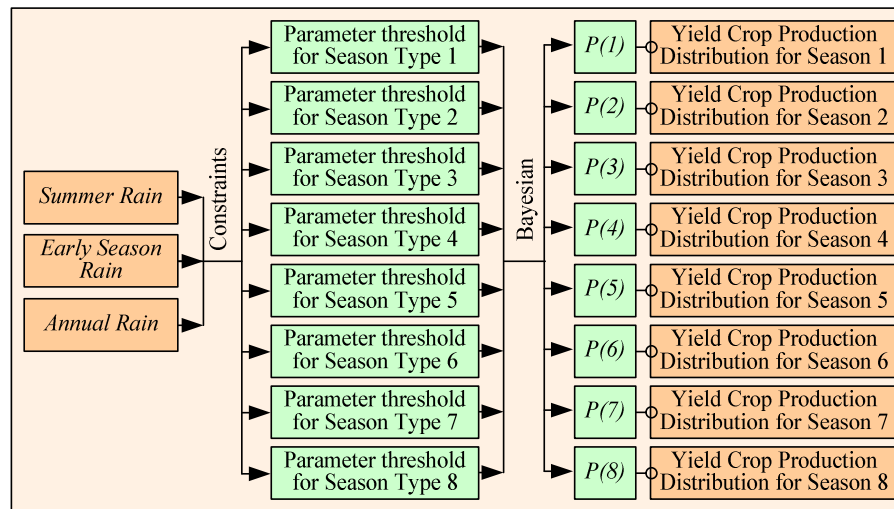

Figure 4.25 Crop production based on season type probability

Unlike the conventional method for determining a probability value, the conditional probability value is determined based on the events that have occurred, such as the occurrence of events  $A$ , given that event  $B$  has occurred,  $P(A|B)$  (Figure 4.26a):

$$P(A|B) = \frac{P(A \cap B)}{P(B)} \quad (4.11)$$

Figure 4.26b illustrates a sample space  $S$  of Beverley rainfall data with 102 years of data classified into eight season types (Table 4.2). Of all the 102 years, 36 years had summer rainfalls greater than 42.32mm. From these 36 years specified, 14 had early season rainfall smaller or equal to 80mm. In 41 other years, early season rainfall was smaller than 80mm and summer rainfall smaller than 42.32mm. Subsequently,

$$P(B) = \frac{55}{102}, \quad P(C) = \frac{36}{102}, \quad P(B \cap C) = \frac{14}{102} \quad (4.12)$$

where event  $B$  indicates early season rainfall smaller than 80mm and event  $C$  indicates summer rainfall greater than 42.32mm.

However, assuming it was known that the data were filtered based on the condition that summer rain was greater than 42.32mm, it is then necessary to determine the probability of the filtered years as having early season rainfall smaller or equal to

80mm. In this case, the conditional probability situation with event  $B$  given the presence of event  $C$  is (Figure 4.26c):

$$\therefore P(B|C) = \frac{P(B \cap C)}{P(C)} = \frac{14/102}{36/102} = \frac{14}{36} \quad (4.13)$$

Moreover, additional constraints can restrict the sample space even further. Figure 4.26c illustrates a sample space  $S$ , based on the years with summer rain greater than 42.32mm. The probability of a season where the annual rain is smaller or equal than 431.61mm (event  $A$ ), and with an early season rainfall smaller or equal to 80mm is (i.e. conditional probability of event  $A$  occurrence given event  $B$ ):

$$\begin{aligned} \therefore P(A) &= \frac{15}{36}, \quad P(B) = \frac{14}{36}, \quad P(A \cap B) = \frac{3}{36} \\ \therefore P(A|B) &= \frac{3/36}{14/36} = \frac{3}{14} \end{aligned} \quad (4.14)$$

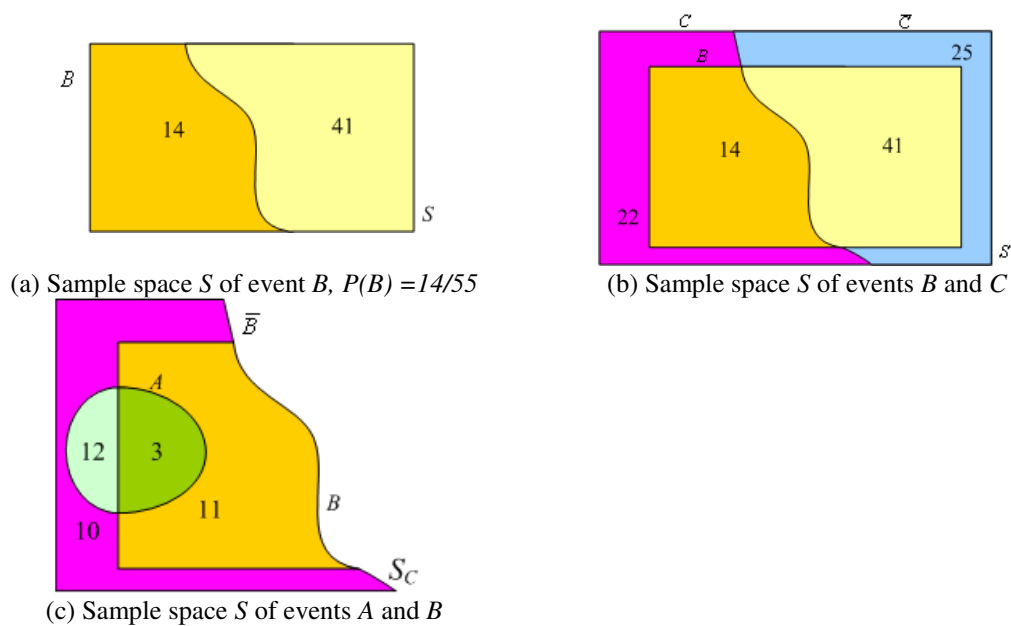

Figure 4.26 Venn diagram of Beverley weather data

In essence, conditional probability will have a pyramid effect (i.e. coning) in the sample space. The provision of larger amounts of information, such as actual summer rainfall, would constrain the sample space, indicating an increase of the probability of a certain event occurring and thus reducing the uncertainty on the type of season unfolding. Accordingly, this practice also needs to be reflected in the *MOLup* model, where additional information (e.g. rainfall data) constrains the sample space. As such, a new set of probability values portraying the possibility of a season type occurring is recalculated (Figure 4.25 and Pseudo-code 4.4).



**Obtain\_SeasonProbability()**

Obtain current weather conditions: summer, early season and annual rainfall  
 Constraint season type classes based on information given  
 Determine the constraints season parameter  
 FOR all constrained season  $i$   
     Determine probability of season  $i$  to occur (conditional probability)  
     Attach the probability obtained to the crop yield production of season type  $i$   
 FOR all constrained season  $i$   
     Determine the array portion (to be filled by crop production from season type  $i$ )  
     FOR all location prepared in the crop production array (aggregate)  
     Employ Monte Carlo to obtain crop production from season type  $i$  randomly

Pseudo-code 4.4 Obtaining the probability of a season type using current information and perform aggregation on the crop production for a data driven process

#### 4.3.4.3.2 Knowledge driven approaches

According to Zadeh (1992), humans have a strong ability to reason in a complex situation. Henceforth, expert knowledge can be more powerful than data driven approaches where the prediction is based on exact statistical computations. In most cases it will be essential for the experts to present their knowledge in a subjective probability manner.

Numerous uncertainty calculi have been proposed for representing expert knowledge, such as Evidence theory, Fuzzy logic, Possibility theory (Section 2.7) and others. All of these are based on different perceptions and deal with various kinds of uncertain data (Dubois and Prade 1989). Nevertheless, they all deal with uncertainty without sharp numerical probabilities, generally termed as *imprecise probabilities* (Baroni and Vicig 2003; Walley 2000).

It is suggested by many researchers that most of the time experts pass on information using natural language (Walley and de Cooman 2001). Human judgements are often unclear and hard to estimate using exact numerical values. Most of the time they offer their subjective opinions and knowledge verbally by employing linguistic description on a likelihood of an event rather than a definite value (Metternicht 1999). These linguistic terms are somewhat fuzzy, but they are meaningful. The linguistic possibility value can also be defined as a range of possibility values with a boundary of minimum  $\underline{P}(A)$  and maximum  $\bar{P}(A)$  possibility, as the following shows (with code  $i = 1, \dots, n$ ) (see Table 4.5 for sample):

$$P_i(A) = (\underline{P}(A), \bar{P}(A)): \underline{P}(A) \leq \bar{P}(A) \quad ; \underline{P}(A), \bar{P}(A) \in [0,1] \quad (4.15)$$

Zadeh (1978) suggested that linguistic uncertainty should be able to be effectively modelled by possibility measurements which are considered subjective measurements expressing expert knowledge that an event may occur. Metternicht (1999) suggests that instead of measuring the linguistic scale incessantly, a discrete linguistic scale could be implemented. A linguistic scale ranging from one to nine was adopted to categorise the fuzzy membership function (see Table 4.5). The scale is an adaptation of the one proposed by Metternicht (1999).

Table 4.5 Possibility Likelihood Linguistic scale description

Code $i$	Possibility Likelihood (Linguistic)	Degree of Possibility (Membership)	
		Minimum membership Value $(\underline{P}_i)$	Maximum Membership Value $(\overline{P}_i)$
1	Impossible	0.00	0.01
2	Not possible to happen	0.01	0.10
3	Very unlikely to happen	0.11	0.20
4	Unlikely to happen	0.21	0.30
5	Neither unlikely nor likely to happen	0.31	0.40
6	Likely to happen	0.41	0.50
7	Very likely to happen	0.51	0.60
8	Extremely likely to happen	0.61	0.80
9	Happening	0.81	1.00

The information obtained from the expert is a subjective probability and generally cannot directly be employed for general processes, or in this case, the generation of crop production distributions (Dubois *et al.* 1993). Commonly, a procedure is utilised to transform the possibility into a probability value. Numerous possibility/probability transformation methods have been proposed: Voorbraak's Bayesian transformation (Voorbraak 1989), Pignistic probability (Smets 1990), Plausibility (or cautious) probabilistic transformation (Cobb and Shenoy 2003), Belief probabilistic transformation (Daniel 2005) and *transformation problem* (TP) (Baroni and Vicig 2005, 2003). Nevertheless, the integration of the possibility-probability transformation method into *MOLup* is outside of the scope of this thesis. Therefore, a simple but logical approach is employed as the transformation method.

As such, a set of likelihood *possibility P* values, in the linguistic term, for each of the season types is obtained from the user. The value is an indication of the likelihood that a certain season type is going to occur during the year. The *possibility P* value given for each season type is then employed to categorise the crop production

distributions and generate a set of crop production classes  $i$  ( $i = 1, \dots, n$  and  $n = 9$ , see Table 4.5) based on their likelihood of occurrence during the year (see Figure 4.27 for sample).

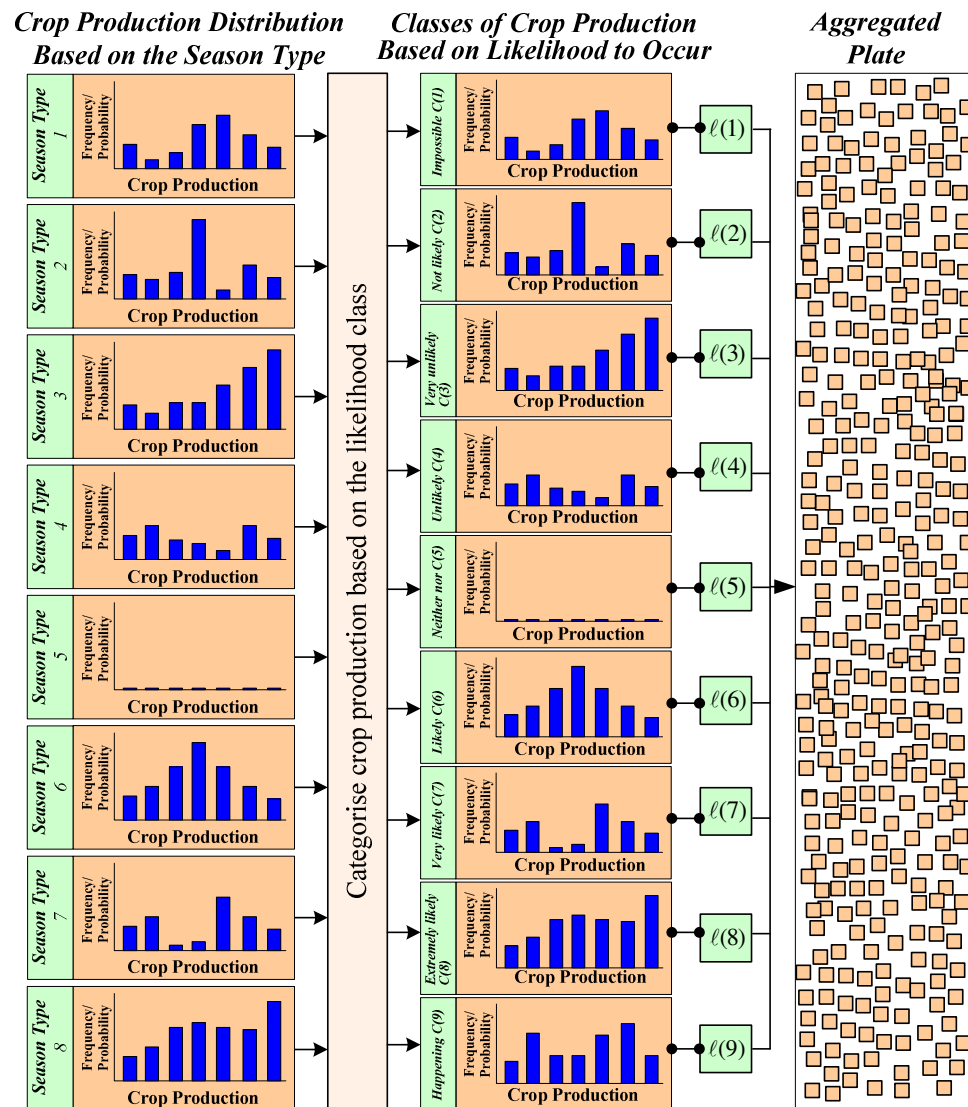

Figure 4.27 Categorisation of crop production distribution (based on season type) into classes of crop production, based on  $P$  possibility classes. The *normalised chance*  $C$  is then evaluated and used to aggregate crop production

As part of the result, only the likelihood classes  $i$  that exist with crop production values are known as “existing classes” and denoted as  $|C_i| \neq \emptyset$ . For every class  $i$ , a *chance*  $C$  value is evaluated by weighting its maximum membership value ( $\bar{P}_i$ ) with *weight*  $W$ . The *weight*  $W$  is the maximum membership value ( $\bar{P}_i$ ) of the “smallest existing” likelihood class  $i$ :

$$W = \text{MAX}\{P_{\text{MIN}(i)}\} \quad (4.16)$$

$$C_i = \frac{\text{MAX}\{P_i\}}{W} \quad (4.17)$$

The *chance C* values are then normalised to *normalised chance ℓ* values (Figure 4.27). The *normalised chance ℓ value* is the indicator representing the likelihood probability of an event occurring (Figure 4.28). It is the relative value of the chance *C* of the class with the total summation of *chance C* values of the “existing classes” (see Pseudo-code 4.5) (with code  $i = 1, \dots, n$ ):

$$\ell_i = \frac{(C_i * \mathfrak{S}_i)}{\sum_i (C_i * \mathfrak{S}_i)} \quad (4.18)$$

where,

$$\mathfrak{S}_i = \begin{cases} 1, & |C_i| \neq 0 \\ 0, & |C_i| = 0 \end{cases}$$

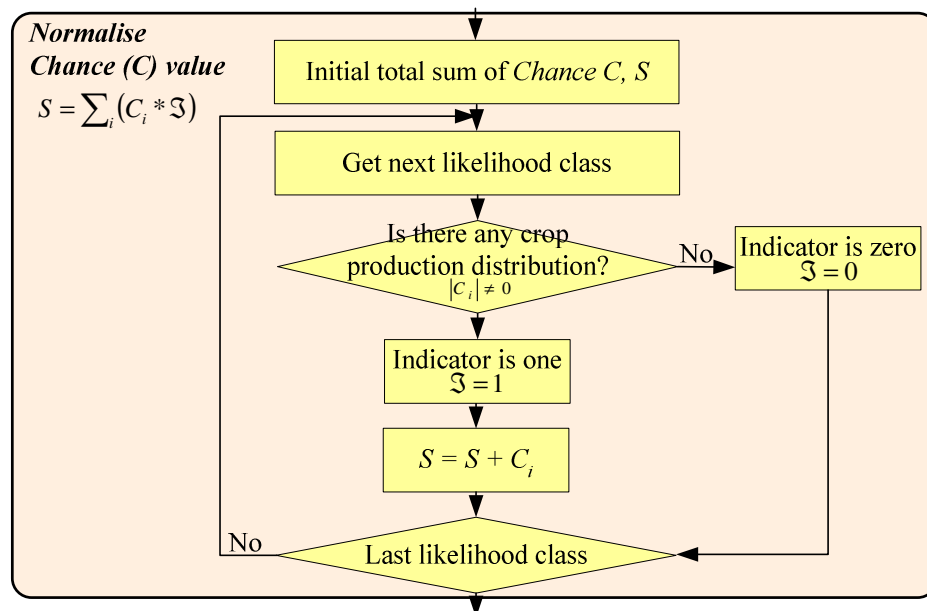

Figure 4.28 Additive *chance (C)* value (see Pseudo-code 4.5)

Finally, Monte Carlo simulation is then employed to obtain the iteratively selected crop production based on the proportion given by the *normalised chance ℓ* value (Figure 4.27 for sample). In addition, it is worth acknowledging that every expert has a different opinion on what is regarded as the correct “possibility” amount. Based on this perspective, experts are encouraged to customise the “possibility” values stated in Table 4.5 based on their opinion.

```

Obtain_SeasonPossibility()
  Obtain current weather conditions: Summer, early season and annual rainfall
  Constraint season type classes based on information given
  Obtain prediction from the expert (linguistic likelihood possibility scale j)
  FOR all linguistic likelihood possibility scale j given
    Group all crop production which has the same level of possibilities of j
  Call Normalise_Chance_cValue()
  FOR all linguistic likelihood possibility scale j given
    Determine the portion of array (based on the seasons' chance to occur)
  FOR all location prepared in the array (AggregatePlate)
    Employ Monte Carlo to obtain crop production from group j

Normalise_Chance_cValue()
  FOR all likelihood classes i
    IF class "exist" then
      Sum up the chance C value
  FOR all "existing" likelihood classes i
    IF class "exist" then
      Normalise C value

```

Pseudo-code 4.5 Obtaining the possibility likelihood of the season and perform aggregation on the crop production for a knowledge driven process

#### 4.3.5 Commodity price

As mentioned briefly in Section 4.3.2, the product price can be based on two different types of trading systems: contract trading (certain) or cash trading (uncertain). The contract trading is related to an agreed crop production contract price and volume, which are locked-in prior to harvesting. In this case, the pricing of crop production will be a simple constant value provided by the user.

*MOLup* uses a Monte Carlo simulation approach to capture the uncertainty within cash trading. The outcome of the simulation is a set of likely product price distributions that will be matched (again by employing Monte Carlo simulation) with the crop production to generate *gross margin (unit)* and *gross margin (product)* distributions (Figure 4.13).

##### 4.3.5.1 Spot cash price

*MOLup* uses two approaches for predicting the spot cash market price. The first approach uses historical spot cash price (i.e. Data Driven approach) (see Section 4.3.5.1.1); while the second is based on the current cash price with the additional subjective variability range (see Section 4.3.5.1.2). Each approach has its own benefits and shortcomings (see Section 4.3.5.1.3).

#### 4.3.5.1.1 Data driven approach

In this approach, the spot cash market for crop production is predicted based on weather data. The estimation is based on historical spot price from different companies such as the AWB, ABB, GrainCorp, Emerald and AgraCorp. Each of these companies usually makes different purchase offers. The variation in the spot prices per company illustrates the range for possible spot prices of a crop over the years. Although it is acknowledged that crop price is also related to the movement in exchange rates (especially US dollar), world stock on hand, the world market (supply and demand) and global geo-political conditions. There is a need for a specific and thorough study to be conducted to determine all aspects that influence crop price, but this is beyond the scope of this thesis.

The process for estimating the spot cash price based on weather data is similar to the approach used for predicting crop production based on weather information (see Section 4.3.4.1 - Section 4.3.4.3). A set of historical spot cash prices from different companies is used to estimate the spot cash price. The historical spot cash prices are then grouped, forming a distribution of cash price based on the season types defined in Table 4.2 (see Figure 4.29). A set of conditional probability values or possibility values, used to forecast crop production based on the weather data, are then used to estimate the distribution of spot cash price (see Psuedo-code 4.6).

```

Obtain_EstimationSpotPrice_Subjective()
FOR all crop product i
  Obtain current crop spot price and the variability
  FOR n iterative
    Obtain the Box-Muller standard normally distributed value Z
    Obtain the normally distribution X by using Z value
  Store the data

```

Pseudo-code 4.6 Obtaining the estimation of the spot market price

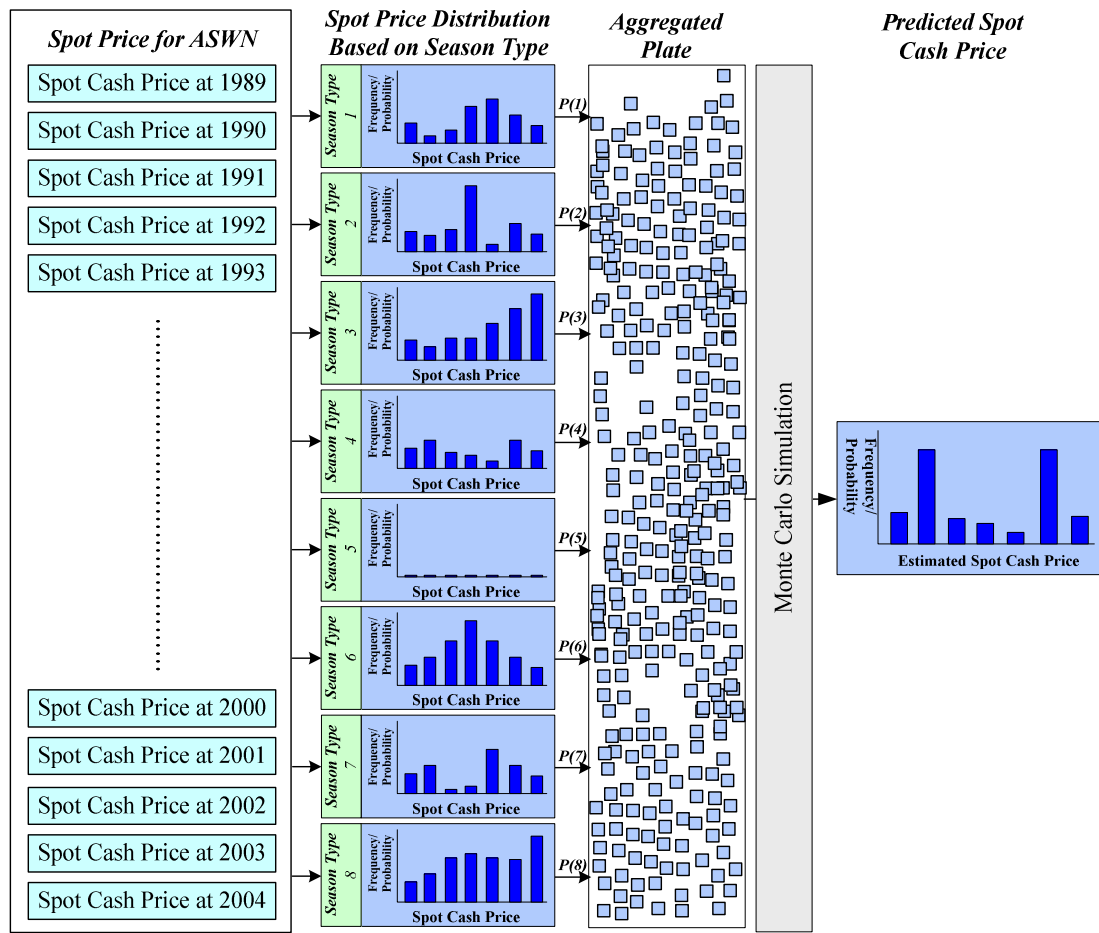

Figure 4.29 Work example on estimating spot cash price distribution (of ASWN) by using a simple probability value for each season type (see Psuedo-code 4.6)

4.3.5.1.2 Hybrid data and knowledge driven approach

In the subjective approach, the model uses the current spot price as well as information given by the user regarding the possible range of variability of the price. It has been assumed that spot prices are normally distributed with the mean value  $\mu$ , as the current spot price and the standard deviation is the variability  $\sigma$  given by the user (Figure 4.30).

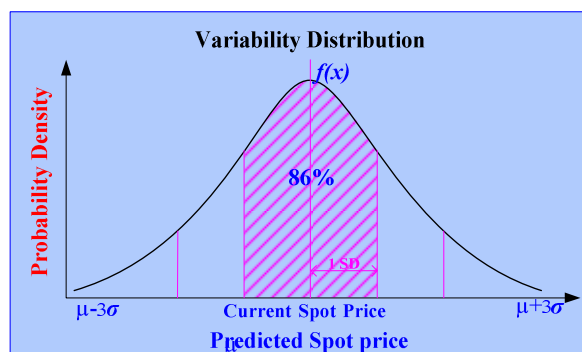

Figure 4.30 Spot price distribution

These two parameters,  $\mu$  and  $\sigma^2$ , completely determine the shape and location of the normal density function, whose functional form is given by,

$$f(x) = \frac{1}{\sqrt{2\pi\sigma^2}} e^{-\frac{(x-\mu)^2}{2\sigma^2}} \quad (4.19)$$

Any normally distributed random variable  $X$ , with parameters  $\mu$  and  $\sigma^2$  has a *standard normal distribution*  $Z$ , as follows:

$$Z = \frac{X - \mu}{\sigma} \quad (4.20)$$

Subsequently, the random variable  $X$  can be evaluated by using the *standard normal distribution*  $Z$  value, as follows:

$$X = Z\sigma + \mu \quad (4.21)$$

$$\text{where, } E(X) = \sigma E(Z) + \mu = \mu \quad (4.22)$$

$$\text{and } V(X) = \sigma^2 V(Z) = \sigma^2 \quad (4.23)$$

The normal distribution is most easily simulated using the *Box-Muller* method, which generates an independent *standard normal distribution*  $Z$  with zero mean  $\mu$  and unit variance  $\sigma^2$  (see Pseudo-code 4.7). In such cases, given that  $r$  and  $\phi$  are independent and uniformly distributed in  $(0,1]$ , i.e. *Unif*(0,1), then

$$Z = \cos(2\pi\phi) \sqrt{-2 \ln r} \quad (4.24)$$

is the standard normal distribution which is ranged

$$-3 \leq Z \leq 3 \quad (4.25)$$

Accordingly, the arbitrary normal distribution with mean  $\mu$  and variance of  $\sigma^2$  can be obtained by employing equation (4.21). The process will then iteratively run  $n$  times (i.e. Monte Carlo simulation) (Pseudo-code 4.7) to form a distribution of spot cash price (see Figure 4.31).

```

Obtain_EstimationSpotPrice_Subjective()
FOR all crop product i
  Obtain current crop spot price and the variability
  FOR n iterative
    Obtain the Box-Muller standard normally distributed value Z
    Obtain the normally distribution X by using Z value
    Store the data

```

Pseudo-code 4.7 Estimate spot market price using subjective information



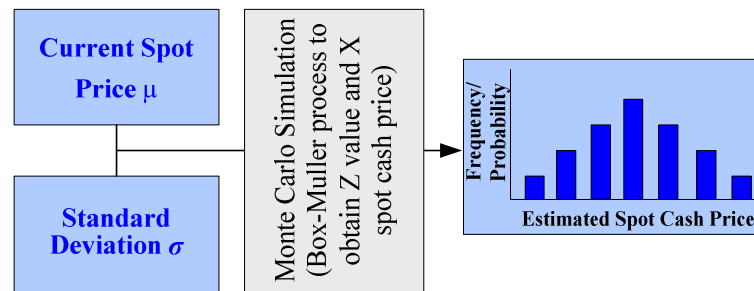

Figure 4.31 Example of estimating spot cash price distribution by using the current spot price and (subjective) variability/standard deviation

#### 4.3.5.1.3 Advantages and disadvantages of each forecasting method

Patterson *et al.* (2005) note that historical price data can usually provide a simple estimation for future price behaviour. However, this may not hold true if there are significant structural changes that would impact the commodity or, if the factors that influence the price variation no longer exist. This method requires a comprehensive and high quality cash price data set to be used for prediction. The data set must be large enough to be able to effectively represent the overall population, without being too old.

Comparatively, the knowledge approach that uses current spot price supplemented with expert subjective information on the range of price variability is better suited to the actual decision-making environment.

#### 4.3.6 Environmental impact simulator

Environmental impact is one of the competing objectives in determining the suitable whole-farm land-use plan. *MOLup* utilises an environmental impact simulator called *Grains Environmental Data Tool* (GEDT) developed by Altham (2003) to estimate the environmental impact caused by selected land-use options. GEDT is an Environmental Life Cycle Assessment tool developed to assess the potential environmental impact associated with farming and processes involving food production that transform the grains to final consumption products, such as wheat-to-bread, barley-to-beer and canola-to-oil (Narayanaswamy *et al.* 2005).

GEDT incorporates all the environmental impacts that occur at every stage along the production chain (Table 4.6 and Figure 4.32) (Narayanaswamy *et al.* 2003), but this

research only uses those environmental impacts that are directly related to the farm production.

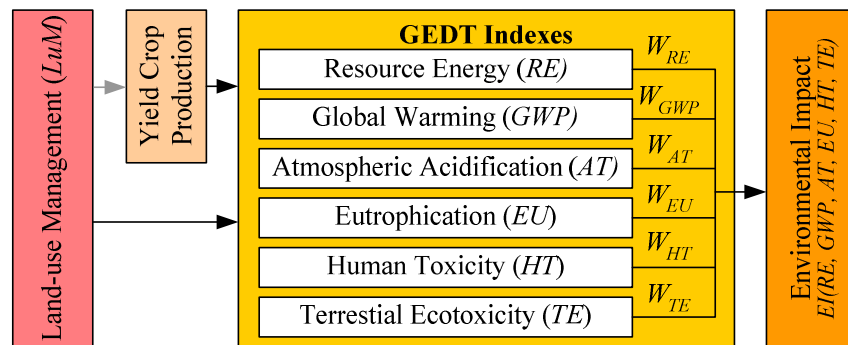

Figure 4.32 Environmental impact simulator processes

Table 4.6 Farming processes that causes environmental effects

Stages	Methods and Applications (Land-use management-LuM)	
Pre Farm production	Mining and extraction	Spray chemical production
	Fertiliser production	Transportation
Farm production	Grain type and seeding rate	Fertiliser applications and method
	Soil type	Chemical application and method
	Yield crop production	Machinery farm production
	Transportation	
Storage	Transportation	
Processing	Transportation	

GEDT evaluates a number of environmental impact categories (Narayanaswamy *et al.* 2003) (Figure 4.32): Resource energy ( $RE$  in MJ/MJ); Global warming ( $GWP_x$  in kg CO<sub>2</sub> equ/kg); Atmospheric acidification ( $AT_x$  kg SO<sub>2</sub> equ/kg); Eutrophication ( $EU_x$  in kg (PO<sub>4</sub>)<sup>3-</sup> equ/kg); Human toxicity ( $HT_x$  in kg 1,4 DCB equ/kg) and Terrestrial ecotoxicity ( $TE_x$  in kg 1,4 DCB equ/kg). Table 2.1 shows a categorisation of the environmental impact evaluated by GEDT on the basis of the environmental damage caused. Further detail regarding GEDT are provided on Narayanaswamy *et al.*(2004).

The global warming value (measured in kg CO<sub>2</sub> equ/kg) is evaluated as the impact of anthropogenic emissions on the absorption of heat radiation by the atmosphere. The global warming potential is an estimated relative measurement of a given mass contributing to global warming over a 100-year time horizon. It is measured as follows:

$$GWP_F = Emission_F * GWP_{100} \quad (4.26)$$

Atmospheric acidification (measured in kg SO<sub>2</sub> equ/kg) is the potential of acid rain formation and water acidification due to a particular release of gasses, such as emissions of sulphur dioxide and oxides of nitrogen. It is measured as follows:

$$AT_F = Emission_F * AT_{factor} \quad (4.27)$$

Eutrophication (measured in kg (PO<sub>4</sub>)<sup>3-</sup> equ/kg) is defined as a process where the water ecosystem periodically receives excessive amounts of chemical nutrients (primarily phosphorus, nitrogen, and carbon). It is measured as follows:

$$EU_F = Emission_F * EU_{factor} \quad (4.28)$$

The human toxicity (measured in kg 1,4 DCB equ/kg) impact is the impact index reflecting the potential harm on human health due to the toxic elements released during grain production (particularly during the application of agro-chemicals). It is measured as follows:

$$HT_F = \sum_{air,water,agri\_soil} (Emission_F * HT_{factor}) \quad (4.29)$$

Terrestrial ecotoxicity (measured in kg 1,4 DCB equ/kg) is the impact on terrestrial flora and fauna due to toxic elements and is measured as follows:

$$TE_F = \sum_{air,water,agri\_soil} (Emission_F * TE_{factor}) \quad (4.30)$$

The resource energy is the total energy required to perform all of the processes within the crop production cycle. This includes the energy employed to mine, extract, distribute and transport a specified resource (such as fertiliser and sprays), with an additional heating value for the fuel consumed in the process (Narayanaswamy *et al.* 2003). It is measured as follows:

$$RE_{fossil} = RE_{fossil\_factor} * H \quad (4.31)$$

$$RE_{fossil\_electricity} = \frac{RE_{fossil}}{Eff_{Electricity\_Generation}}$$

where  $RE_{fossil}$  is the Resource Energy use of a fossil fuel;  $RE_{fossil\_factor}$  is the Resource Energy factor of the fossil fuel;  $RE_{fossil\_electricity}$  is the Resource Energy use of a fossil fuel based on electricity generation; and  $Eff_{Electricity\_Generation}$  is the Efficiency of electricity generation.

GEDT generates six environmental indicators. However, because each is measured in different units, there is a need to normalise these values before use in *MOLup*. In this instance, *MOLup* considers that all GEDT indices have the same relative importance to the overall environmental impact value. *MOLup* employs the inverse of the maximum ( $GEDT_{max}$ ) of each GEDT index ( $i$ ) as the weight ( $W_{GEDTi}$ ):

$$W_{GEDTi} = GEDT_{i_{max}}^{-1} \quad (4.32)$$

Therefore, the environmental impact  $EI$  of a Land-use management option  $LuM$  is determined by the total summation of the product of a constant  $C$  with the weighted  $GEDT$  indices ( $i$ ) (Figure 4.32):

$$EI_{LU} = \sum_i C(W_{GEDTi} * GEDTi) \quad (4.33)$$

Since the weighted  $GEDT$  indices are relative values (i.e. percentage value ranging from zero to one), it was considered that the constant value  $C$  should be equal to 100. As a result, the generated value of environmental impact ( $EI$ ) can range from zero to 600. The higher the  $EI$  value, the higher the impact caused to the environment.

As most of the GEDT indices use crop production as one of their input parameter (as illustrated in the sample in Table 4.7) and the predicted crop production is a distribution of possible crop production strategies, the output of the GEDT simulator for each land-use management option is not a unique value, but rather a set of distributed values (Figure 4.33).

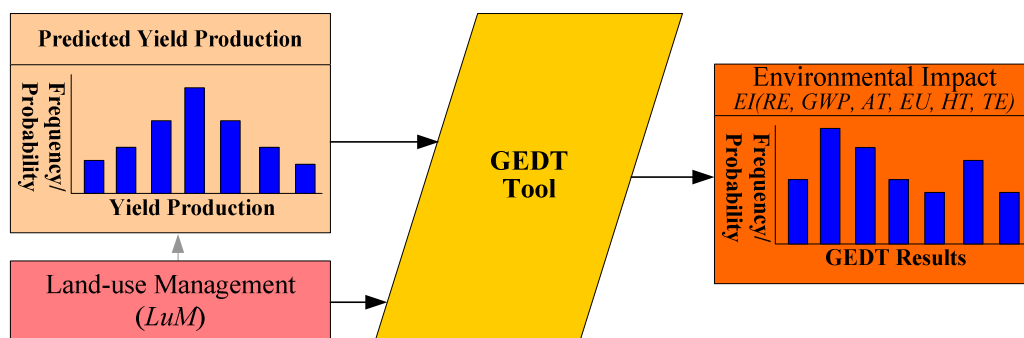

Figure 4.33 Environmental impact results based on one  $LuM$  option

Table 4.7 shows a set of input and output values generated by GEDT. It shows that with a constant crop production (columns  $A$  versus  $B$ , and  $C$  versus  $D$ ), different levels of nitrogen application have caused an increased environmental impact, especially the global warming potential and the resources energy categories. A

comparison between columns *A* versus *C* and Column *B* versus *D* shows that the excessive use of nitrogen fertiliser during crop production without suitable weather conditions or soil properties will induce eutrophication and a significantly higher normalised GEDT value.

Table 4.7 GEDT sample input and output for wheat crop production

<b>Land-use Management Input</b>	<b>A</b>	<b>B</b>	<b>C</b>	<b>D</b>
Crop Production (t/ha) - Wheat	5	5	3	3
Nitrogen (kg/ha)	30	100	30	100
Seeding Fuel Consumption (Litres)	3	3	3	3
Topdressing Fuel Consumption (Litres)	1	1	1	1
Harvesting Fuel Consumption (Litres)	4	4	4	4
Fuel to receivable point (Litres)	3.6	3.6	3.6	3.6
<b>GEDT Output</b>				
Global Warming Potential (kg CO <sub>2</sub> equ/kg)	165	326.81	245.72	<b>514.58</b>
Human Toxicity (kg 1,4 DCB equ/kg)	0.03	0.03	0.03	<b>0.03</b>
Atmospheric Acidification (kg SO <sub>2</sub> equ/kg)	0.31	0.44	0.4	<b>0.61</b>
Terrestrial Eco-toxicity (kg 1,4 DCB equ/kg)	0	0	0	0
Eutrophication (kg (PO <sub>4</sub> ) <sup>3-</sup> equ/kg)	0	0.17	0	<b>5.59</b>
Resource Energy (MJ/MJ)	478.43	819.29	629	<b>1198</b>
<b>Normalised GEDT result</b>				
GEDT result utilised by <i>MOLup</i>	222.82	307.07	265.83	500.00

Narayanaswamy *et al.*(2003) stated that the “multi-indices” may be aggregated into one representative numerical value by applying weights to each index (Figure 4.32). The weight applied is based on the revealed socio-political value-choices, or on natural science principles. However, it has also been suggested that this numerical factor may vary from place to place due to the difference in socio-economic and political priorities. Further reading can be found in (Munn 1979).

#### 4.4 Search and Optimise Phase

The next phase of *MOLup* is to search and select (i.e. optimise) an optimum whole-farm land-use plan (*WLuM*/chromosome). In this phase, a search method is used to form unique chromosomes (Figure 4.34). Two main methods were proposed in searching for the optimum land-use management combination for the whole-farm: Exhaustive Search (ES) and Genetic Algorithm (GA), the latter being discussed in Chapter 3. Lastly, *Pareto Optimisation* is used to determine the most satisfying chromosomes (see Section 4.4.3).

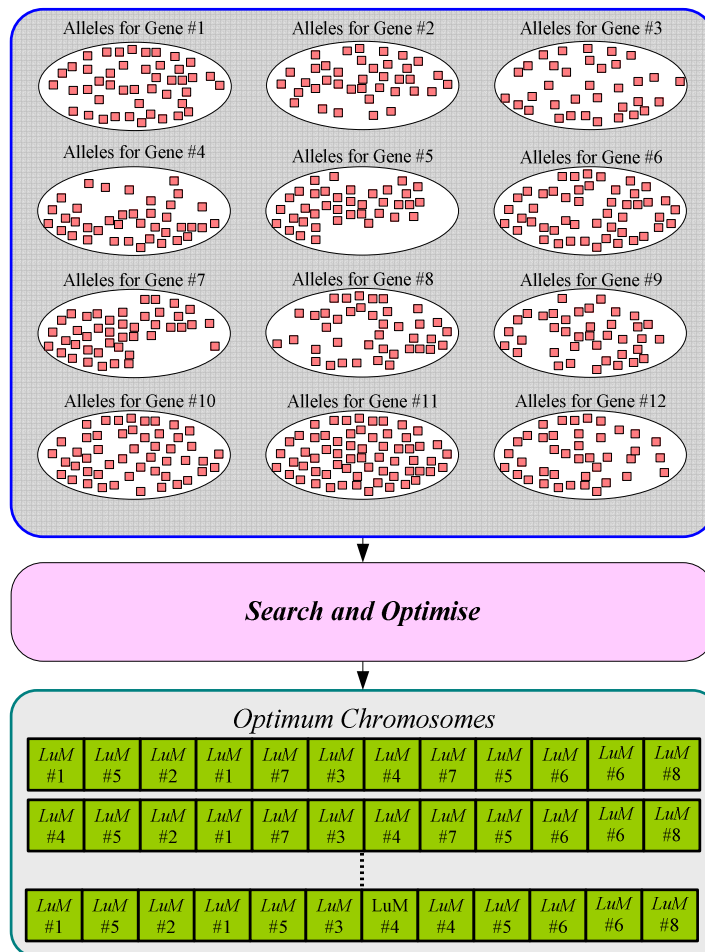

Figure 4.34 The input and output of the search and optimise phase

The whole-farm land-use plan (*WLuM*), or so-called *chromosome*, is formed by a unique combination of land-use management options for every paddock within the whole-farm (Figure 4.35). The assignment of a paddock land-use management option, applied on each of the different paddocks gives a set of trade-off values (see Section 4.4.2), namely: Profit and Environmental Impact.

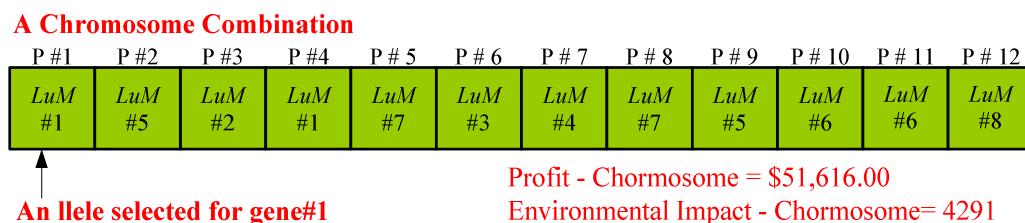

Figure 4.35 A sample of whole-farm land-use plan with chromosome fitness values (i.e. profit and environmental impact)

#### 4.4.1 Search and optimise methods

The GA and ES methods are entirely different from one another. While GAs (see Section 3.1) attempt to search and select optimum solutions by a series of iterative processes (evolutions) while the ES method employs a straightforward search method to determine a set of solutions and select the optimum solution from the resulting set.

A heuristic approach can be integrated into the search design to reduce the size of the search area. In the heuristic approach, the alleles from each gene collected in the input phase are retrieved from the database, and permuted against each other to form individual and unique chromosomes (Figure 4.34). The superior chromosome is then selected from all the chromosomes formed. It then becomes the output of the search and optimisation phase (Figure 4.34). The optimisation process for detecting a superior chromosome is performed based on trade-off variables at the most *utopian* solution.

##### 4.4.1.1 Exhaustive Search

The ES method applies a complete systematic search based on the concept that no stone should be left unturned. Generally, the approach will find all possible solutions (*WLuM*), where each and every solution will be assessed for its objective value (see Section 4.4.2) and weighed against one another for their *Pareto Optimal* characteristic (see Section 4.4.3).

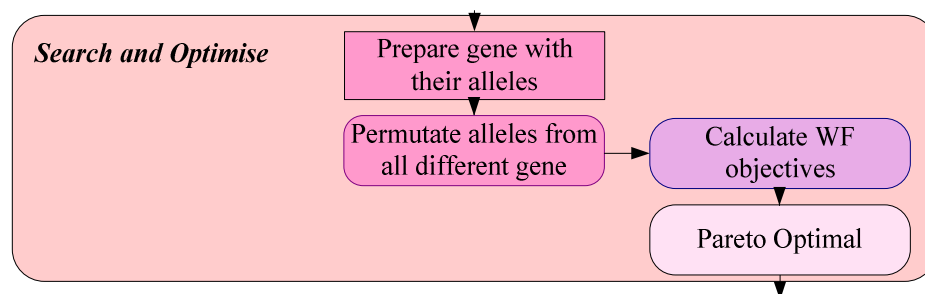

Figure 4.36 Search and optimise by using exhaustive search approach

The solution is formed in permutating the alleles set up for each paddock in the input phase to form unique chromosomes (Figure 4.36). Each chromosome is unique, with at least one of the genes of a chromosome being different from the next chromosome.

The permutation process employs a recursive method to obtain individual chromosomes (see Pseudo-code 4.8).

```

Permutates ()
  Get next gene
  WHILE the gene is valid do
    Get all Alleles of the gene
    FOR all Alleles
      Set paddock with an allele
      Call Permutates()
    IF gene is the last gene in the chromosome
      Copy the chromosome and store them
  
```

Pseudo-code 4.8 Recursive process to perform permutation

The main problem encountered with this approach is that the method may cause a combinatorial explosion and cause an extremely high computation time for practical purposes (Blum and Roli 2003). In agricultural land-use management there are a number of different decision variables with a number of alternative levels which are in turn constrained by the paddock attributes and condition (Figure 4.10). Each unique permutation of these alternatives represents a unique land management plan (e.g. allele *LuM#2* in gene *P#1*, see Figure 4.37) (Figure 4.3).

	P #1	P #2	P #3	P #4	P #5	P #6	P #7	P #8	P #9	P #10	P #11	P #12
<b>Choice</b>	LuM #1	LuM #2	LuM #1	LuM #1	LuM #1	LuM #3	LuM #2	LuM #7	LuM #1	LuM #2	LuM #1	LuM #1
	LuM #2	LuM #5	LuM #2	LuM #4	LuM #2	LuM #4	LuM #5	LuM #9	LuM #3	LuM #3	LuM #6	LuM #4
	LuM #3	LuM #6	LuM #3	LuM #6	LuM #3	LuM #8	LuM #7		LuM #5	LuM #4	LuM #9	LuM #6
	LuM #4	LuM #8	LuM #7		LuM #4		LuM #8		LuM #9	LuM #6		LuM #8
	5	X	4	X	4	X	3	X	5	X	3	X
<b>Total Combinations = 5,529,600 Chromosomes Combinations</b>												
										4		
										↑ 4 different Alleles		
<b>One Chromosome Combination</b>												
	P #1	P #2	P #3	P #4	P #5	P #6	P #7	P #8	P #9	P #10	P #11	P #12
	LuM #1	LuM #5	LuM #2	LuM #1	LuM #7	LuM #3	LuM #4	LuM #7	LuM #5	LuM #6	LuM #6	LuM #8

Figure 4.37 Explosive combination of whole-farm land-use plan options

Each gene has a different set of allele combinations (Figure 4.37). The number of alleles per gene depends on the attributes and constraints of the gene itself. The combinatorial explosion does not end here. The alleles of each gene will then permute with other alleles from other genes to obtain a unique combination of chromosome solutions. These combinations can cause a flood of whole-farm management options (i.e. chromosomes). Figure 4.37 represents twelve genes (i.e. paddocks) with each having a set of suitable alleles. For example, gene#1 has five



alleles while gene#2 has four alleles and so on. Subsequently, the permutation of different alleles from each gene would cause an explosive number. For example, Figure 4.37 shows that the permutation of the alleles from different paddocks generates up to 5,529,600 chromosomes. This explosive number of combinations is formed by a considerably small number of choices available for each gene considered.

#### 4.4.1.2 Integrating a heuristic technique

There are a number of methods that can help in speeding up the brute force search. One such method integrates heuristics on each paddock. A heuristic for a given problem is a technique of training the search target towards the promising region.

*MOLup* employs heuristic techniques to reduce the search effort by cutting ineffective solutions out of the search area and directing the search into promising regions where superior solutions exist.

*MOLup* uses a heuristic method based in the *pre-selection* of prominent land-use management options for each gene, which are then ranked by their importance (Figure 4.38). Subsequently, the search region for each gene is restricted and the number of chromosomes reduced to the most superior ones.

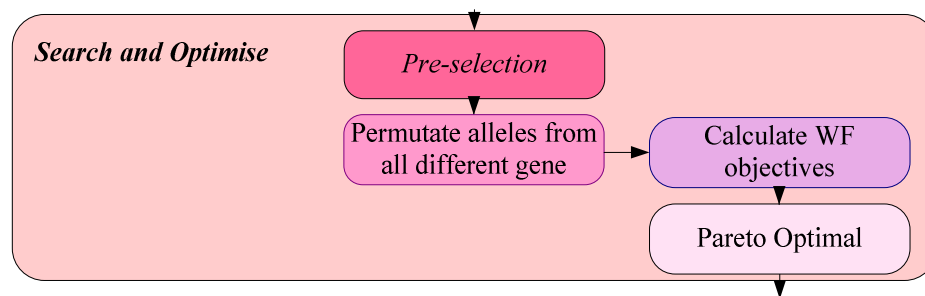

Figure 4.38 Search (employing *pre-selection* method) and optimise

The *Pre-selection* method employs Compromise Programming and a *Pareto Optimal* method to identify the best alleles of a gene (Figures 4.39 and 4.40). Firstly, the “bad” alleles are filtered out from the set by taking out all the alleles with a negative gross margin. The filtered alleles will then go through a *Pareto Optimal* process (see Section 4.4.3), where only *Pareto* optimum points are selected and the rest of the points are removed from the alleles list for a paddock. Nevertheless, it is considered

that when the *Pareto Optimal* process is applied unnecessarily it can eliminate possible prominent solutions. This process can be turned-off by the decision-maker, if required, during the parameter initialisation stage (Section 4.2).

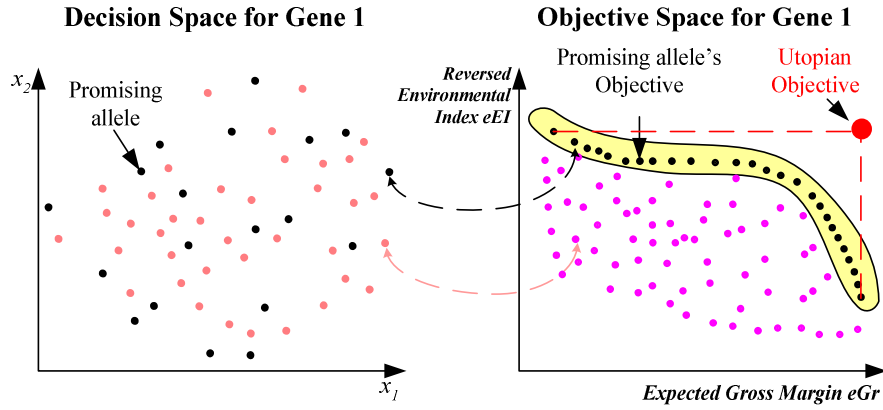

Figure 4.39 Cutting the chase (see Figure 4.40 for procedure)

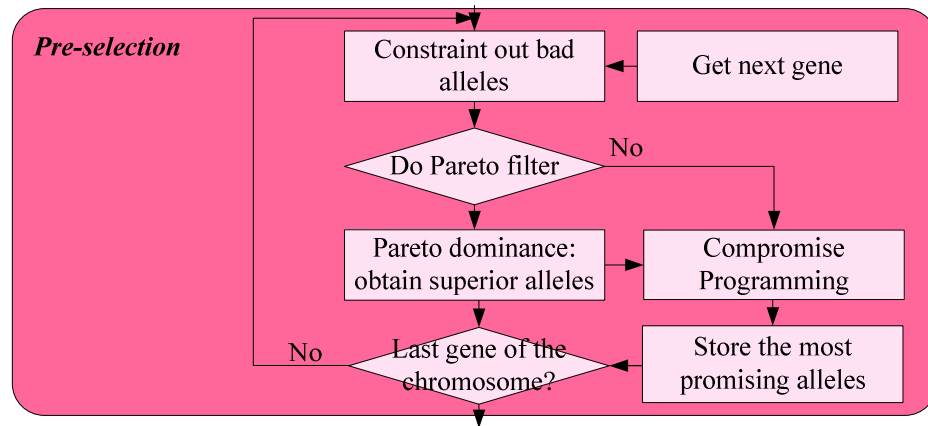

Figure 4.40 *Pre-selection* process

In Compromise Programming, the alleles are given a rank value based on the utopian solution of the gene. The utopian (ordinal) point of the gene is determined by utilising the highest expected gross margin and lowest expected environmental impact from all the *LuM* options within a paddock  $x$ , as follows:

$$eGM_{utopian} = \text{MAX}_x \{eGM_{LuM}\} \quad (4.34)$$

$$eEI_{utopian} = \text{MIN}_x \{eEI_{LuM}\} \quad (4.35)$$

Based on the utopian solution ( $eGr_{utopian}$ ,  $eEI_{utopian}$ ), the rank ( $Rank_{compromise}$ ) is generally calculated as the shortest distance from the utopian point to the point *LuM*, as the following (Figure 4.39):

$$Rank_{compromise} = \sqrt{(eGM_{LuM} - eGM_{utopian})^2 + (eEI_{LuM} - eEI_{utopian})^2} \quad (4.36)$$

As the gross margin and environmental impact values differ considerably, these need to be normalised to obtain an appropriate estimated rank. This is done by determining the location of the values within a set of ranges. The gross margin range ( $Range_{GM}$ ) is estimated by determining the distance between the extreme values of the gross margin:

$$MAX_{GM_x} = MAX_x \{eGM_{LuM}\} \quad (4.37)$$

$$MIN_{GM_x} = MIN_x \{eGM_{LuM}\} \quad (4.38)$$

$$Range_{GM} = MAX_{GM_x} - MIN_{GM_x} \quad (4.39)$$

The environmental impact range ( $Range_{EI}$ ) also goes through a similar approach. The normalised gross margin value and the environmental impact value can then be calculated as follows:

$$eGM_{LuM\_Norm} = \frac{eGM_{LuM} - MIN_{GM_x}}{Range_{GM}} \quad (4.40)$$

$$eEI_{LuM\_Norm} = \frac{eEI_{LuM} - MIN_{EI_x}}{Range_{EI}} \quad (4.41)$$

Based on the above normalisation approach, the utopian solution ( $eGr_{utopian}$ ,  $eEI_{utopian}$ ) can then be re-calculated as:

$$eGM_{utopian\_Norm} = \frac{eGM_{utopian} - MIN_{GM_x}}{Range_{GM}} = 1 \quad (4.42)$$

$$eEI_{utopian\_Norm} = \frac{eEI_{utopian} - MIN_{EI_x}}{Range_{EI}} = 0 \quad (4.43)$$

Subsequently, the rank ( $Rank_{compromise}$ ) is calculated as the shortest distance from the normalised utopian point to the point of normalised  $LuM$ , as follows:

$$Rank_{compromise} = \sqrt{(eGM_{LuM\_Norm} - 1)^2 + (eEI_{LuM\_Norm})^2} \quad (4.44)$$

Furthermore,  $MOLup$  gives decision-makers a chance to assert their preference on the objective, whether profit or environmental impact, by allowing them to allocate a weight to each objective,  $W_{Pt}$  and  $W_{EI}$ . These weights need to be settled during the parameter initialisation stage (Section 4.2). The asserted weights are then applied as part of the ranking method, transforming the ranking formula to:

$$Rank_{compromise} = \sqrt{\left(\frac{eGM_{LuM\_Norm} - 1}{W_{Pt}}\right)^2 + \left(\frac{eEI_{LuM\_Norm}}{W_{EI}}\right)^2} \quad (4.45)$$

The rank value of the land-use management option given by equation (4.45) is then used as an indicator of the worth of the option. A small rank value indicates closeness of the solution to a utopian solution and is thus, more worthy. Based on this rank value, the land-use management option is then sorted. Points falling outside the cut-off limit are removed from the alleles list of a particular gene. The cut-off limit can be based on the number of points within the list or the rank threshold values and can be set-up during the initialisation stage (Section 4.2).

It needs to be noted that each gene has a decisive space which corresponds with the trade-off objective value in the objective space (as shown in Figures 4.4 and 4.39). Within the objective space each land-use management option is positioned based on its gross margin  $GM_{LuM}$  and environmental impact  $EI_{LuM}$ . Both  $GM_{LuM}$  (see Figure 4.11 and Section 4.3.2) and  $EI_{LuM}$  (see Figure 4.33 and Section 4.3.6) are in fact represented by data distributions. Essentially, each of the  $GM_{LuM}$  and  $EI_{LuM}$  distributions are aggregated to form a numerical value format and their expected values are calculated using the following equations (i.e.  $GM_{LU}$  and  $EI_{LuM}$ ):

$$GM_{LuM} \approx eGM_{LuM} = \frac{\sum_i GM_{LuM_i}}{n}, \text{ where } i=1, \dots, n \quad (4.46)$$

$$EI_{LuM} \approx eEI_{LuM} = \frac{\sum_j EI_{LuM_j}}{m}, \text{ where } i=1, \dots, n \quad (4.47)$$

It needs to be noted that the term for gross margin,  $GM_{LuM}$  and  $eGM_{LuM}$ , and environmental impact,  $EI_{LuM}$  and  $eEI_{LuM}$ , will be used interchangeably. In this case, the gross margin  $GM_{LuM}$  is approximated by the expected value of the  $GM_{LuM}$  distribution (i.e.  $eGM_{LuM}$ ), while environmental impact  $EI_{LuM}$  is approximated by the expected value of the  $EI_{LuM}$  distribution (i.e.  $eEI_{LuM}$ ).

#### 4.4.2 Whole-farm land-use plan assessment

The whole-farm land-use plan assessment stage determines the objective values, *Profit* and *Environmental impact*, generated by the whole-farm land-use plan application. The assessment of the objective value requires the aggregation of the whole-farm production (Figure 4.41 for sample).

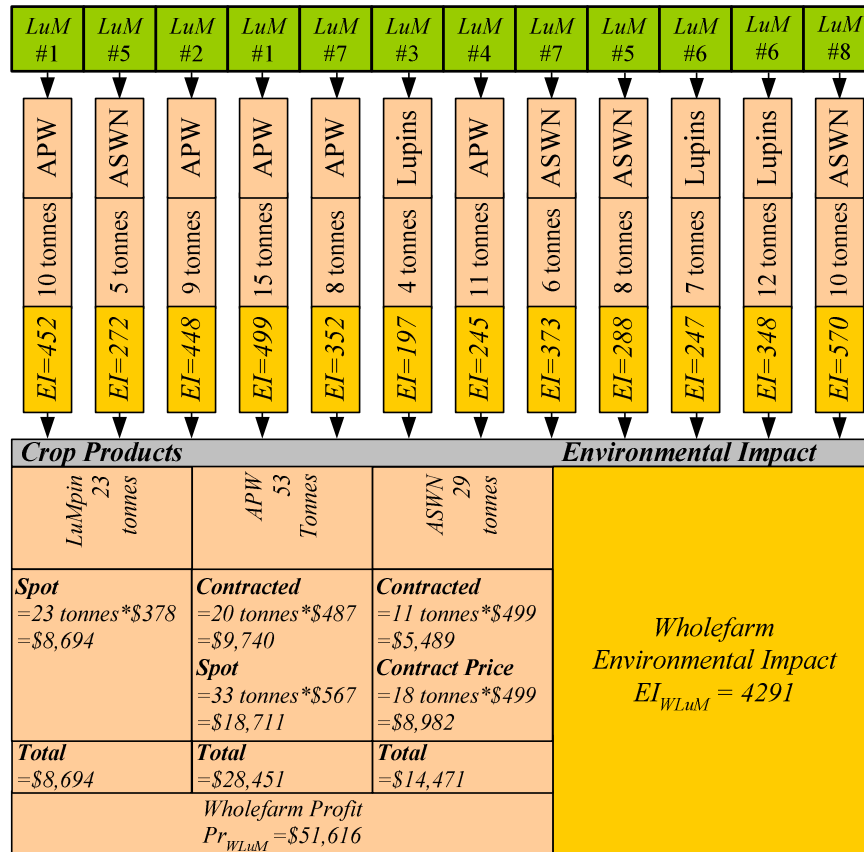

Figure 4.41 Sample of aggregating the whole-farm results

The overall aggregation process of the whole-farm results can be seen in Pseudocode 4.9. In general, the total profit  $Pt_{WLuM}$  is the summation of all *gross income*  $GI$  of a *product*  $k$  generated by the whole-farm land-use plan deducted by the total (i.e. variable and fixed cost) cost  $\epsilon_{WLuM}$ . The total *gross income*  $GI_{WLuM}$  of a product is the total production (in weight  $W$ ) of a crop product  $k$  from all paddocks  $x$  with the expected crop product selling price  $Cr$ , as follows:

$$weight(k) = \sum_x E[weight(x)] , \forall k = product(x) \quad (4.48)$$

$$GI(k) = weight(k) * E[Cr(k)] \quad (4.49)$$

$$Pt_{WLuM} = \left( \sum_k GI(k) \right) - \epsilon_{WLuM} \quad (4.50)$$

$$\epsilon_{WLuM} = \epsilon_{fixed} + \epsilon_{variable} \quad (4.51)$$

The overall profit is determined based on a number of constraints, including the amount contracted and the spot and contract markets at the point of decision (Figure 4.42). When there is a contract constraint (i.e. existing contract), *MOLup* will honour

this by determining the proceeds of this first and the remaining crop is in the spot market (Figure 4.42).

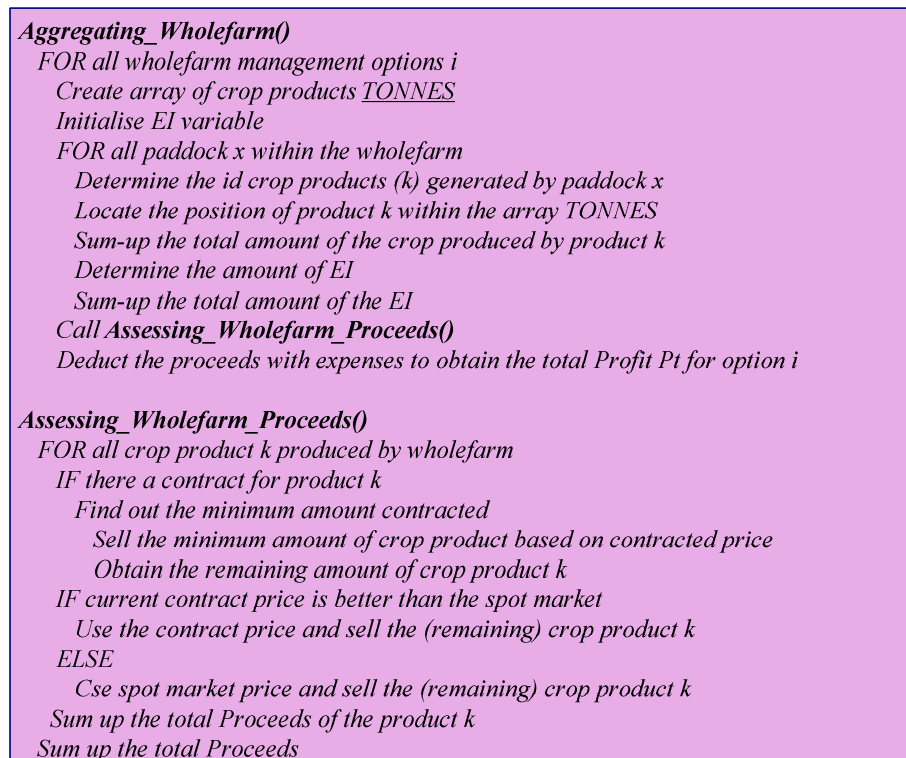

Pseudo-code 4.9 Aggregating whole-farm objective functions

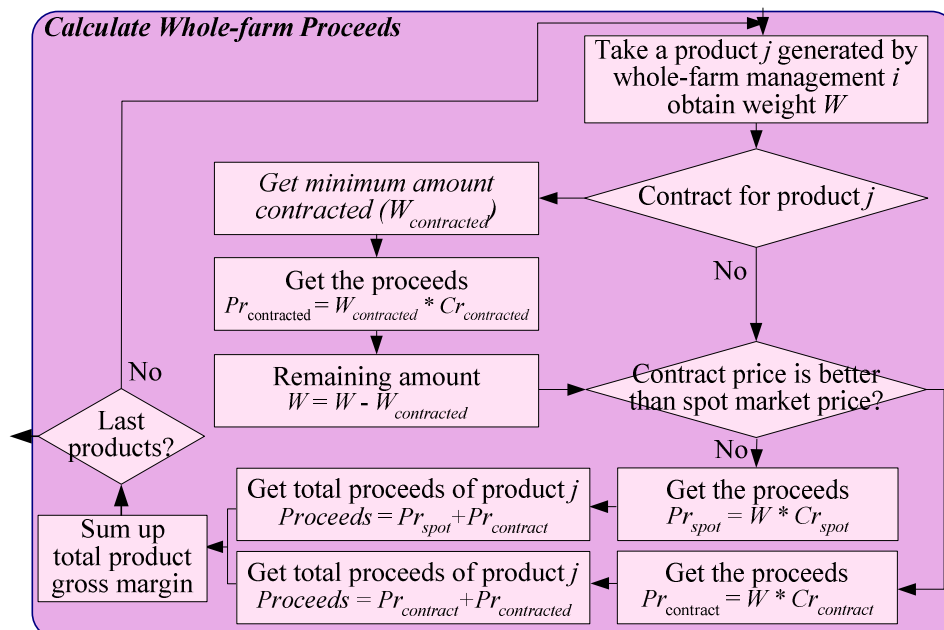

Figure 4.42 Processes for obtaining whole-farm proceeds

The weight utilised in equations (4.48) and (4.49) are the expected values of the crop production distribution of paddock  $x$  (refer to equations (4.1) and (4.2)) and can be calculated as follows (the same approach is applied to the crop price distribution):

$$E[\text{weight}_{LuM}(x)] = \frac{\sum_i \text{weight}_{LuM_i}(x)}{n}, \text{ where } i=1, \dots, n \quad (4.52)$$

$$V[\text{weight}_{LuM}(x)] = \frac{\sum_i (\text{weight}_{LuM_i}(x) - E[\text{weight}_{LuM}(x)])^2}{n} \quad (4.53)$$

The aggregation process also gives a whole-farm environmental impact  $EI_{WLuM}$  value by summing up the *potential* value of the environmental impact  $EI_{LuM}$  from all  $N$  paddocks  $x$  within the whole-farm, as follows ( $x = 1, \dots, N$ ):

$$EI_{WLuM} = \sum_x E[EI_{LuM}(x)] \quad (4.54)$$

As stated in Section 4.3.6, the environmental impact per paddock ( $EI_{LuM}$ ) ranges from zero to 600 per hectare. Therefore, the environmental impact of a whole-farm ( $EI_{WLuM}$ ) can vary from zero to 600 times the total size of the whole-farm cropped area.

The usage of the term “potential” in the *Potential Environmental Impact* is due to the uncertainty that exists in the *Environmental Impact* ( $EI$ ) variable caused by the dynamic variable crop yield. The *Potential Environmental Impact* for every land-use management option ( $LuM$ ) is estimated by using the expected value and the variance of the *Environmental Impact* distribution for each  $LuM$ , is calculated as follows (refer to equations (4.1) and (4.2)):

$$E[EI_{LuM}(x)] = \frac{\sum_i EI_{LuM_i}(x)}{n}, \text{ where } i=1, \dots, n \quad (4.55)$$

$$V[EI_{LuM}(x)] = \frac{\sum_i (EI_{LuM_i}(x) - E[EI_{LuM}(x)])^2}{n} \quad (4.56)$$

The expected *Environmental Impact* is shown graphically as the **Reversed Environmental Impact** ( $REI_{WLuM}$ ) value. This is done for display purposes only. The **Reversed Environmental Impact** is evaluated by acquiring the maximum of all  $EI_{WLuM}$  values and deducting each of the  $EI_{WLuM}$  values from the anchor value:

$$\text{Anchor} = \text{Max}\{EI_{WLuM}\} \quad (4.57)$$

$$REI_{WLuM} = \text{Anchor} - EI_{ELuM} \quad (4.58)$$

#### 4.4.3 Pareto optimal

The *Pareto Optimal* is determined by separating two different types of points (i.e. points refer to whole-farm management options): *superior* (dominating solutions) and *inferior* (i.e. dominated solutions) (see Definitions 2.5 to 2.9). Each whole-farm management option (*WLuM*) point is positioned based on its objective values: the *Profit (Pt)* and *Reversed Environmental Impact (EI)* (i.e. evaluated in Section 4.4.2).

Generally, the procedure to determine *Pareto Optimal* points is performed by observing each point of the set, and then determining if they are superior *Pareto Optimal* points against another point. An extensive number of points in the set create a lengthy analysis process (Pseudo-code 4.10).

```

set_ParetoOptimal()
  Obtain all points (WLuM) set
  Initialise all points as superior point
  FOR all points WLuM i
    Set the next point WLuM i as OBSERVATION_POINT
    Get a subset of "inferior" points by WLuM i from point set
  
```

Pseudo-code 4.10 Simple way of obtaining *Pareto Optimal* points

In *MOLup*, a procedure called *Pareto filtering* has been developed to determine the *Pareto Optimal* in a fast and efficient manner, especially when there is a substantial number of points in the data set. The fundamental mechanism behind this process is similar to a “pyramidising” process, where “easily known” inferior points are excluded prior to the process of determining the *Pareto Optimal* points (Figure 4.43). This reduces the number of points thereby reducing the time to determine the *Pareto Optimal* points.

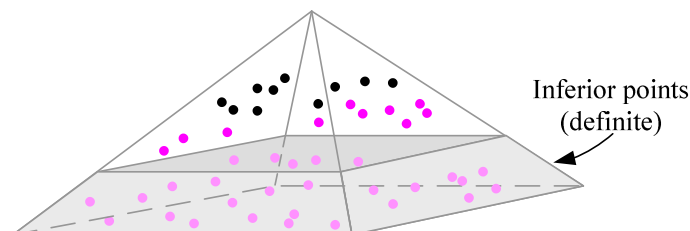

Figure 4.43 Pyramidising processes, excluding definite “inferior” points prior to the *Pareto Optimisation* process



The method is designed to generate an array of cells (with  $N$  rows and  $M$  columns) and map them on top of the extent of the point arrangements (Figure 4.44). All of the  $WLuM$  points located within a cell are recorded as the inhabitant of the cell and are saved as the attribute of the cell. Cells are then compared against each other.

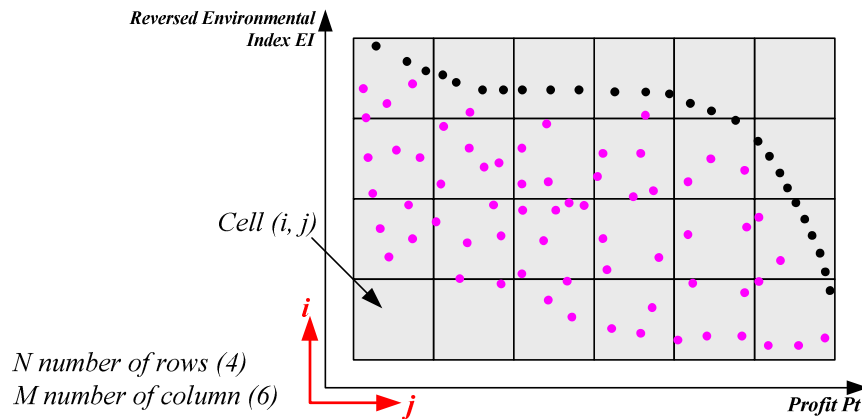

Figure 4.44 Creating “Cells” of a *Pareto* plot

The key idea behind this is to perform “associations ( $\triangleleft$ )” of a cell  $x$  (Figure 4.44), located at row  $i$  and column  $j$ , with cell  $y$ , located at row  $k$  and column  $l$ , that are superiorly located (i.e. cells which are located in a higher row as well as a higher column). If a superior cell  $y$  has  $WLuM$  point(s) within the cell, then the  $WLuM$  point(s) within cell  $x$  are inferior points (see Figure 4.45 for examples). If there is no inhabited cell  $y$  that is superior to cell  $x$ , then cell  $x$  and its inhabitants are declared to be superior. This process of associations ( $\triangleleft$ ) of cell  $x$  is performed on all cells that are not in row  $N$ , or column  $M$  and can be formally stated as:

$$x(i, j) \triangleleft y(k, l) \quad (4.59)$$

where,  $i < k$  and  $j < l$   
 $1 \leq i < N$  and  $1 \leq j < M$   
 $1 \leq k \leq N$  and  $1 \leq l \leq M$

The *Pareto* filtering process is performed via a number of phases (Figure 4.46): setting the extreme values, generating a *Pareto* array, setting a *Pareto* Plot, performing a *Pareto Optimal* process globally, and a performing *Pareto Optimal* process locally. In setting the extreme values phase, the extreme values of the profit and environmental impact are determined. The extreme values are then used to generate the extent of the region, partitioning the area and generating new cells (i.e.

sub-points) (Figure 4.46). The *Pareto* array is then used as the mapping bins of the *WLuM* points. Every point located within a certain cell bin  $x$  is recorded (plotted) as the inhabitant of that cell  $x$ .

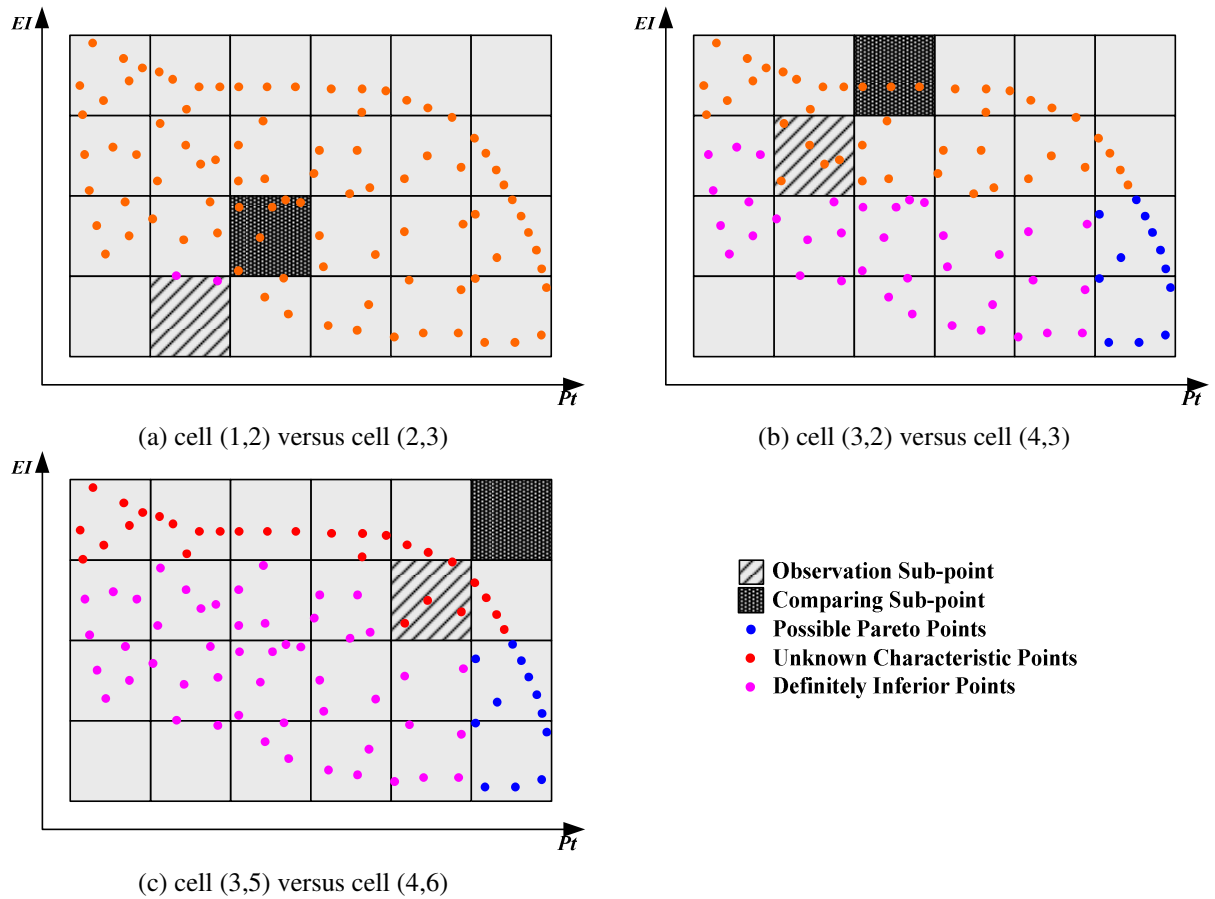

Figure 4.45 Example of *Pareto* filtering

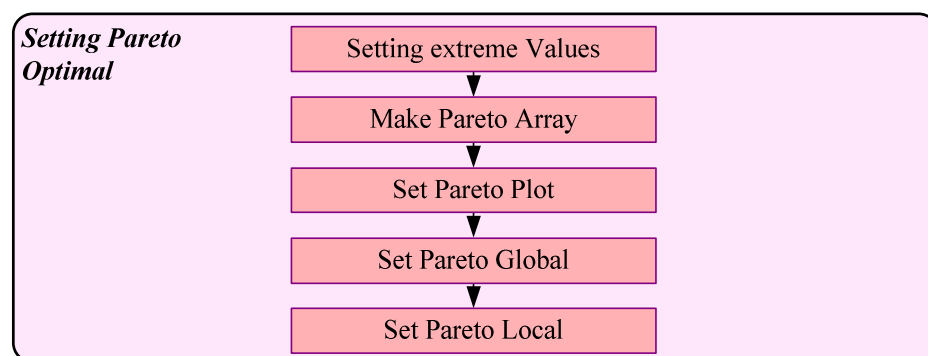

Figure 4.46 Setting *Pareto Optimal* processes (see Pseudo-code 4.11)

The cell in row  $i$  and column  $j$ , is then compared globally. In this phase, *Pareto Optimisation* is performed on sub-points, where inferior sub-points and their inhabitants are branded as dominated points; while the superior sub-points and their

inhabitants are branded as *possible Pareto Optimal* points (Figures 4.45 and 4.46). The *possible Pareto Optimal* points are then aggregated and the *Pareto Optimisation* is performed on this set of points (See Pseudo-code 4.11).

```

make_ParetoArray()
  Determine range values of Profit
  Determine the number of width array of Pareto Plot
  Determine range values of Environmental Impact
  Determine the number of height array of Pareto Plot
  Create cells of points in the array of Pareto Plot
  Initialise the cells of point

set_ParetoPlot()
  FOR all Wholefarm Land use management (WLuM) i
    Determine cells (location) of WLuM i
    Copy information of the WLuM into the cell

set_ParetoGlobal()
  FOR all row i in the ParetoPlot
    FOR all column j in the ParetoPlot
      Set cell(i,j) as the OBSERVATION_SUBPOINT
      IF there are WLuM points in the OBSERVATION_SUBPOINT
        Go to the next row
      WHILE not found any superior cells
        Go to the next column
      WHILE not found any superior cells
        Set cell(i+1,j+1) as the COMPARING_SUBPOINT
        IF there are WLuM points in the COMPARING_SUBPOINT
          Set cell(i,j) as inferior point
        Go to the next column
      Go to the next row
    IF Not found any superior of OBSERVATION_SUBPOINT
      Set the OBSERVATION_SUBPOINT CELL AS POSSIBLE_PARETO

set_ParetoLocal()
  Obtain all POSSIBLE_PARETO points (WLuM) set
  WHILE there are still pre-superior points WLuM i
    Find a subset of inferior points by WLuM i from pre-superior set
    Mark all inferior points subset (by WLuM i) as "inferior points"
    Set point i as superior point
    Refresh (obtain all pre-superior points (WLuM) set but not a superior point)
    Get a point from pre-superior set

```

Pseudo-code 4.11 Obtaining *Pareto Optimal* points

## 4.5 Output Phase

In the output phase, the solution obtained from the previous phases will then be presented in such a way that it is easy for the user to grasp the overall result (Figure 4.47). It has already been stated that the main purpose of *MOLup* is to generate a whole-farm optimum solution, which involves determining optimal trade-off

solutions between competing objectives such as maximising profit  $Pt$  and minimising the environmental effect  $EI$ , by combining a set of resources available to the farm, subject to certain constraints.

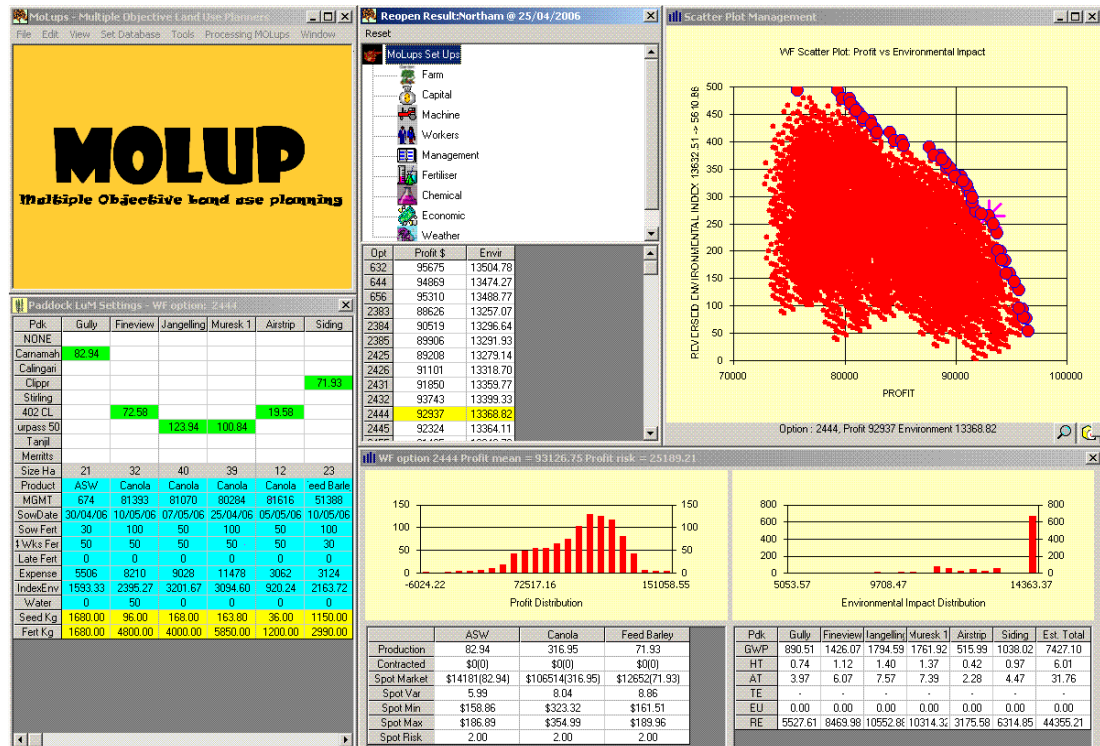

Figure 4.47 A sample of *MOLup* overall output presentation

*MOLup* presents a number of outputs. The output presented is based on the three types of data entity employed by *MOLup* (Figure 4.48):

- Population (Section 4.5.1): the population of chromosomes output offers information on the whole-farm land-use plan options as a complete set;
- Selected Chromosomes (Section 4.5.2): When a whole-farm land-use plan option is chosen, then the “intermediate” characteristics of the option are presented to the user;
- Alleles of the selected chromosomes (Section 4.5.3): The combination set of paddock land-use management plans within the selected whole-farm option are presented as part of the outcome of the options.

Level of entity	Output	Presentation Method
Populations of chromosome 	Profit $Pt_{WLuM}$ versus Environmental Impact $EI_{WLuM}$	<i>Scatter Plot</i> 
A chromosome 	Profit $Pt_{WLuM}$ Environmental Impact $EI_{WLuM}$	<i>Histogram</i> 
	Market advice	<i>Tabular settings</i>
	$EI$ signatures $EI_{WLuM}$	<i>Tabular settings</i>
A set combination of alleles 	Land-use Management settings: 1. Crop types 2. Sowing date 3. Fertilising settings 4. Chemical settings 5. Gross margin 6. $EI$ value	<i>Tabular settings</i>

Figure 4.48 Summary of the *MOLup* output

#### 4.5.1 Output portraying all *WLuM* options (populations of chromosomes)

Since the aim of *MOLup* is to act as a decision support system for farmers, one of the crucial *MOLup* outputs consists of offering an overall picture of the complete set of whole-farm land-use plan options. All *MOLup* options are characterised by two objective values: Profit ( $Pt_{WLuM}$ ) and Environmental Impact ( $EI_{WLuM}$ ). *MOLup* uses both graphic, such as scatter plots and numerical (in tabular form) approaches to show this information.

Scatter plots, also known as scatter diagrams are a popular exploratory data analysis technique. The method is usually employed to provide a preliminary understanding of the existing data set. Scatter plots facilitate the analysis of potential relationships between data sets, numerically or quantitatively. The plots allow the user to see the effect that one variable has on another variable by displaying a finite number of points; each having a coordinate on a horizontal  $x$ -axis and vertical  $y$ -axis in a two-

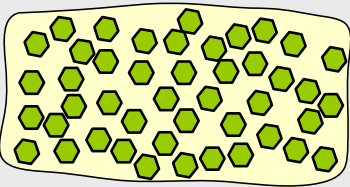
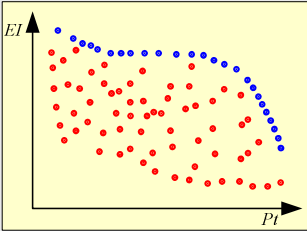
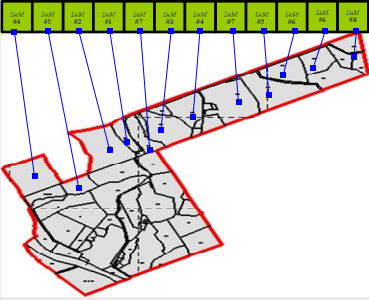
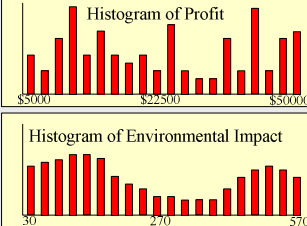
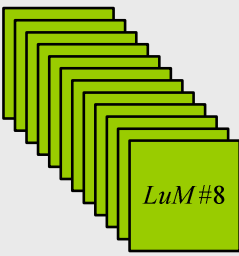
dimensional graph (Figure 4.49-a) or even with the addition of the third dimensional  $z$ -axis (Figure 4.49-b). Moreover, in the scatter diagram additional information can be illustrated as part of point symbology, such as: size, colour, shape or a combination of these features (Figure 4.49-c).

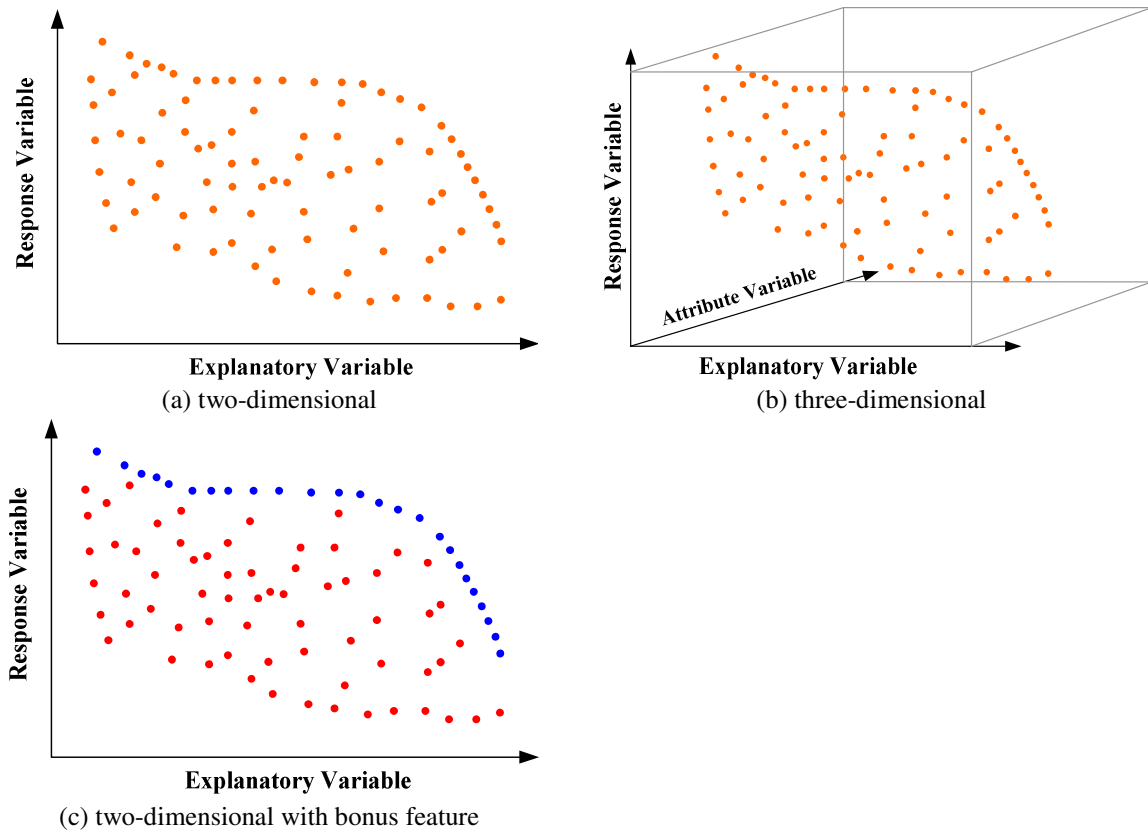

Figure 4.49 Example of a scatter plot

*MOLup* employs the two-dimensional scatter plot with additional attributes by using different colours. Each point within the scatter plot is located based on its objective expected values (Figure 4.50). The settings are:

- The X variable represents the total expected profit for whole-farm land-use plan option  $i$ :

$$X_i = Pt_{WLuM_i} \quad (4.60)$$

- The Y variable represents the reversed value of the total environmental impact (EI) due to the application of a whole-farm land-use plan option  $i$ :

$$Y_i = EI_{WLuM_i} \quad (4.61)$$

- Two distinct colors are employed to differentiate *Pareto Optimal* points and “dominated” points (see Figure 4.51 for an example).

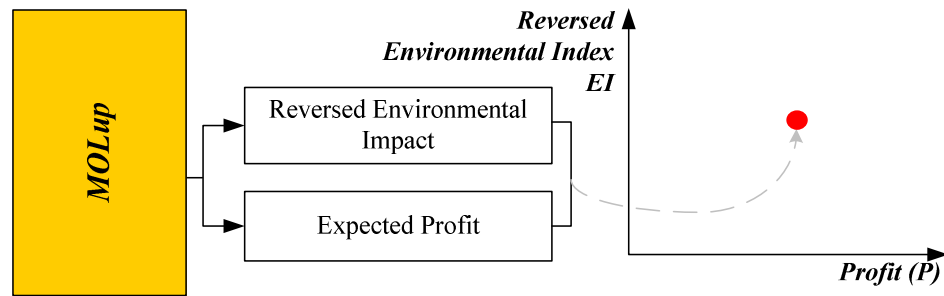

Figure 4.50 *MOLup* scatter plot (see Figure 4.51 for an example)

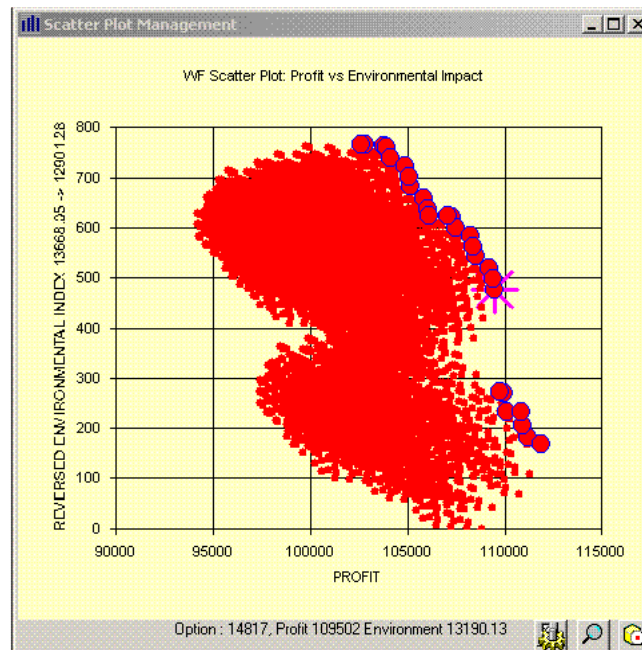

Figure 4.51 A sample of *MOLup* scatter plot

In addition to a scatter diagram, a concise summary of each option within the population set is presented numerically in a tabular form; the *Pareto Front* solution set table (Figure 4.52). Due to the limitation of the prototype, only the *Pareto Optimal* options are presented. The information presented includes:

- Whole-farm management option number;
- The expected profit of the whole-farm management option;
- The expected environmental impact of the whole-farm management options.

Opt	Profit \$	Envir
1486E	108407	13105.52
1487C	109768	13395.99
1494E	105861	13009.42
1494A	106050	13030.18
1481E	111866	13500.64
14817	109502	13190.13
1481E	109201	13149.12
1481E	109390	13169.88
1483E	106152	13042.87
1487E	107103	13044.47
1498E	103954	12906.67
1498A	104143	12927.42

Figure 4.52 *Pareto Front* solution set table: the tabular format contains all solutions that form the *Pareto Front*

As noted earlier, each point within the scatter plot represents an object, which in turn represents a whole-farm land-use management option. The model output allows individual objects to be selected to display more detailed information in terms of the whole-farm plan as well as the plan for each individual paddock. Further explanation can be found in Section 4.5.3.

The selection of a whole-farm management option can be achieved by the following approaches:

- Selection by location is done within the scatter plot screen itself. In this case, the user can select any point within the scatter plot screen to find the most suitable whole-farm management option based on the location of the object (Figure 4.51);
- Selection by numerical value consists of selecting a whole-farm management option object by selecting a solution within the Pareto Front Solution Set Table (Figure 4.52). In this case, only the solutions that form the Pareto Front will be provided;
- Selection by attribute is the selection of a whole-farm management option object by selecting a specific paddock land-use management option for an individual paddock (Figure 4.53). For each paddock a number of pre-selected land-use management options are presented. In this case, the user can constrain a paddock with a given option by selecting one of them.



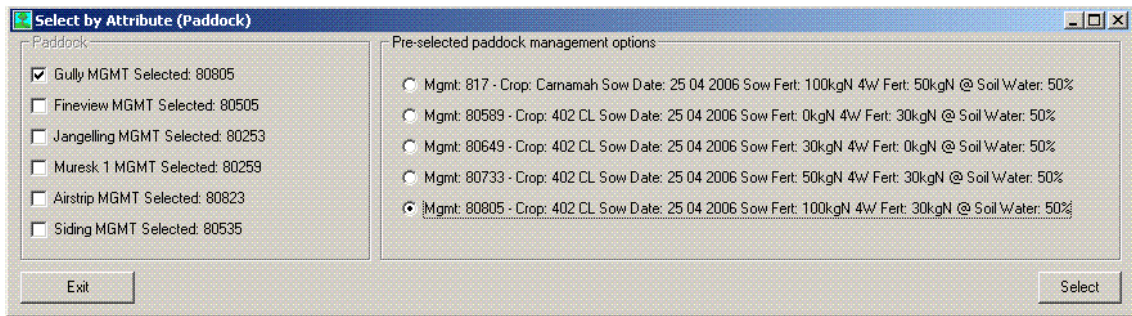

Figure 4.53 Selecting a whole-farm land-use management based on the attribute of each paddock of the whole-farm

In this case, the marginal value theorem can be used to assess the benefits of one solution against another. The marginal value theorem uses the derivative of one point against another to determine how a value changes by associating the movement in a unit of input  $dx$  with the change in output  $dy$ :

$$M = \frac{dy}{dx} \tag{4.62}$$

For example, Figure 4.54 shows a working sample of the calculation of marginal values between two whole-farm management options. The marginal value  $M_1$  for whole-farm management options  $WLuM_1 - WLuM_2$  is as follows:

$$M_1 = \frac{100}{2800} = 0.0357 \tag{4.63}$$

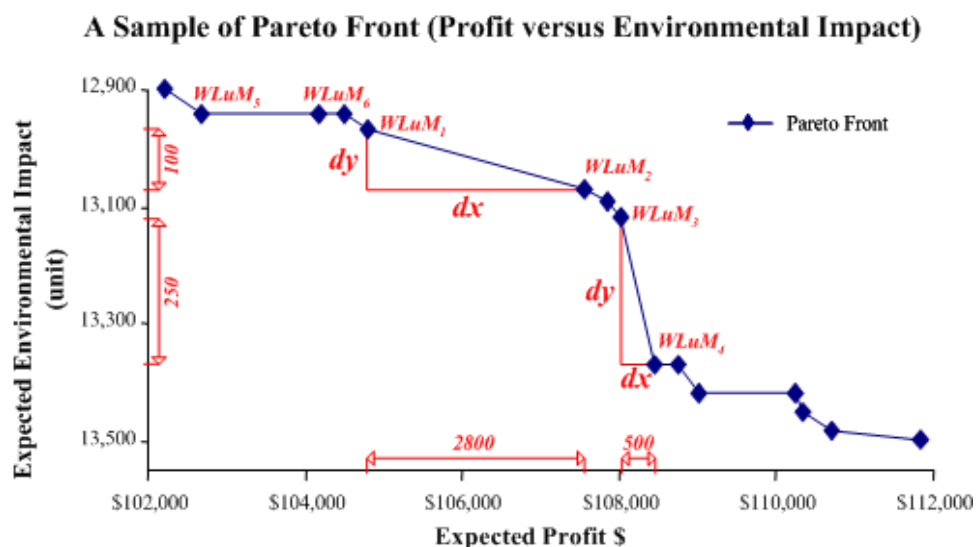

Figure 4.54 A sample of *Pareto Front*

The marginal impact of shifting from  $WLuM_2$  to  $WLuM_1$  is that every unit gain in profit incurs an increase in environmental impact of 0.036 units. While a comparison between options  $WLuM_5$  is and  $WLuM_6$  shows that additional profit can be gained without additional *EI*.

#### 4.5.2 Output portraying a selected *WLuM* option (a chromosome)

Points representing whole-farm management options shown in a scatter plot can be selected dynamically (Figure 4.51). Once one of the whole-farm management options is selected, the following information about that particular option will be provided to the user: the expected profit, profit variability, profit distribution, expected environmental impact, environmental impact variability, distribution of the environmental impact index, marketing advice about the options and a breakdown of the estimated environmental index value. Again, this information is presented in graphic form (histogram), as well as, in a numerical format (in tabular fashion).

##### 4.5.2.1 Histograms

Histograms are used to present the results for profit and environmental impacts. The *Pareto Optimisation* only utilises expected profit and expected environmental impact. However, the aggregate results do not always adequately reflect the variability within the result whilst a histogram does.

For the histogram, the total number of data sets  $N$  can be represented by  $n$  number of disjointed bins  $i$  of the histogram  $h_i$ . This is formulated as:

$$N = \sum_{i=1}^n h_i \quad (4.64)$$

Although there may be other more effective histogram classification methods for displaying the data distribution, *MOLup* only provides equal interval histograms, using the *Freedman and Diaconis* method to determine the width of the bin (see Pseudo-code 4.12). The *Freedman and Diaconis* method (Freedman and Diaconis 1981) is used because of its ability to detect the presence of outliers. As such, the width of the bin is calculated by:

$$w = \frac{2 * IQR}{N^{1/3}} \quad (4.65)$$

```

Histogram()
  Call Bin_Widths()
  Obtain the number of bins n based on the bin width given
  create array FREQUENCY of n bins
  For all bins n
    Determine the ranges (min and max) of bin n
    Find all data that is within the range of bin n
    Count the number of data found and store in the FREQUENCY array n
  call Plot()

Bin_Widths()
  Call calculate_IQRvalues()
  Calculate bin width based on the IQR values.

calculate_IQRvalues()
  Sort the data
  Determine the median of the data
  Define position Q3 (U)
  Obtain the value at Q3 position (U)
  Define position Q1 (L)
  Obtain the value at Q1 position (L)
  Determine the distance between value Q3 and Q1

```

#### Pseudo-code 4.12 Performing histogram

The *IQR* value is the interquartile range of the data and it can be determined by taking the difference between upper and lower quartiles ( $Q3-Q1$ ). The interquartile range spans the middle half of the data set, without considering the highest and the lowest quarter of the data set. The approach attempts to eliminate the influence of the outliers. The quartile values are determined by employing *Tukey's method*. The location for the value of the Lower *L* and Upper *U* quartile of a data set with *N* number of observations is defined as:

$$L = \frac{N+2}{4} \quad (4.66)$$

$$U = \frac{3N+2}{4} \quad (4.67)$$

when *N* is even, and if *N* is odd the Lower *L* and Upper *U* quartile of the data set is:

$$L = \frac{N+3}{4} \quad (4.68)$$

$$U = \frac{3N+1}{4} \quad (4.69)$$

#### 4.5.2.2 Spread tables

Additionally, *MOLup* also provides two spread tables illustrating the farm production based on a per-product basis and the environmental impact indices which are caused by different paddock management options for a range of paddocks. In the first spread

table, the farm production, due to the application of the whole-farm land-use management options, is illustrated based on product classes. To this end, all the information on the grain produced for the chosen whole-farm management option, are presented in a tabular format (Figure 4.55a) along with the crop production (in tonnes) and quality, amount of crop contracted (volume and value), and the spot market sales (value and variability).

The second spread table shows the breakdown of the GEDT environmental impact indices for each paddock (i.e. based on the six GEDT Environmental indices, described in Section 4.3.6), (Figure 4.55b).

	Canola
Production	465.24
Contracted	\$0(0)
Spot Market	\$149267(465.24)
Spot Var	18.84
Spot Min	\$285.31
Spot Max	\$349.90
Spot Risk	3.00

Pdk	Gully	Fineview	Jangelling	Muresk 1	Airstrip	Siding	Est. Total
GWP	897.79	1420.69	1791.67	1749.11	514.83	1032.86	7406.94
HT	0.74	1.12	1.40	1.37	0.42	0.81	5.85
AT	3.98	6.07	7.57	7.38	2.28	4.37	31.64
TE	-	-	-	-	-	-	-
EU	0.00	0.00	0.00	0.00	0.00	0.00	0.00
RE	5547.36	8458.23	10547.11	10287.83	3173.65	6103.64	44117.83

(a) Farm Production

(b) Environmental Index

Figure 4.55 A sample of *MOLup* spread tables

#### 4.5.3 Output portraying the paddock land-use management setting of the selected *WLuM* option (alleles of the chromosomes)

Once a whole-farm land-use management plan has been selected, *MOLup* provides the land-use management output for each paddock in a tabular format. The paddock *LuM* settings table (Figure 4.56) (i.e. note the highlighted crop type presents the crop type suggested for the chosen paddock while ‘++’ indicates other possible crop selection).

Pdk	Gully	Fineview	Jangelling	Muresk 1	Airstrip	Siding
NONE						
Carnamah	++	++				
Calingari						
Clippri						70.94
Stirling						
402 CL	59.87	63.74			31.10	++
urpass 50			147.82	126.15		
Tanill						
Merritts						
Size Ha	21	32	40	39	12	23
Product	Canola	Canola	Canola	Canola	Canola	Feed Barle
MGMT	80805	80505	80253	80283	80823	50536
SowDate	25/04/06	25/04/06	25/04/06	25/04/06	25/04/06	25/04/06
Sow Fert	100	100	100	100	100	100
1 Wks Fert	30	0	0	50	50	50
Late Fert	0	0	0	0	0	0
Expense	5185	7306	9176	10338	3131	3446
IndexEnv	1608.02	2469.25	3212.06	3035.10	957.15	2154.70
Water	50	50	50	50	50	0
Seed Kg	63.00	96.00	168.00	163.80	36.00	1150.00
Fert Kg	2730.00	3200.00	4000.00	5850.00	1800.00	3450.00

Figure 4.56 A sample of paddock *LuM* settings table

From the paddock *LuM* table (as shown in Figure 4.56), the user is able to highlight a particular paddock and to open a dialog box to show per hectare input information for a particular paddock (see Figure 4.57) along with a plot showing trade-offs between gross income and environmental impact.

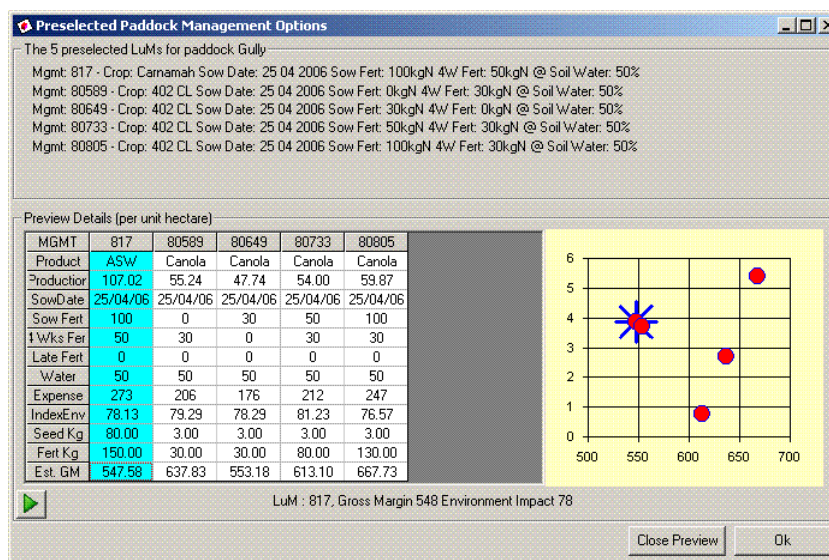

Figure 4.57 Pre-selected land-use management options for *Gully*

#### 4.5.4 Cartographic output

The output also includes an interactive thematic map displaying the land-use plan and provides a number of standard GIS facilities (see Figure 4.58), such as: zoom and pan to manipulate the map; data query to allow a user to perform interactive queries, such as highlight paddocks based on certain land-use management attributes; and an identifying tool that allows each of the paddocks within the farm and its set of attributes to be dynamically selected.

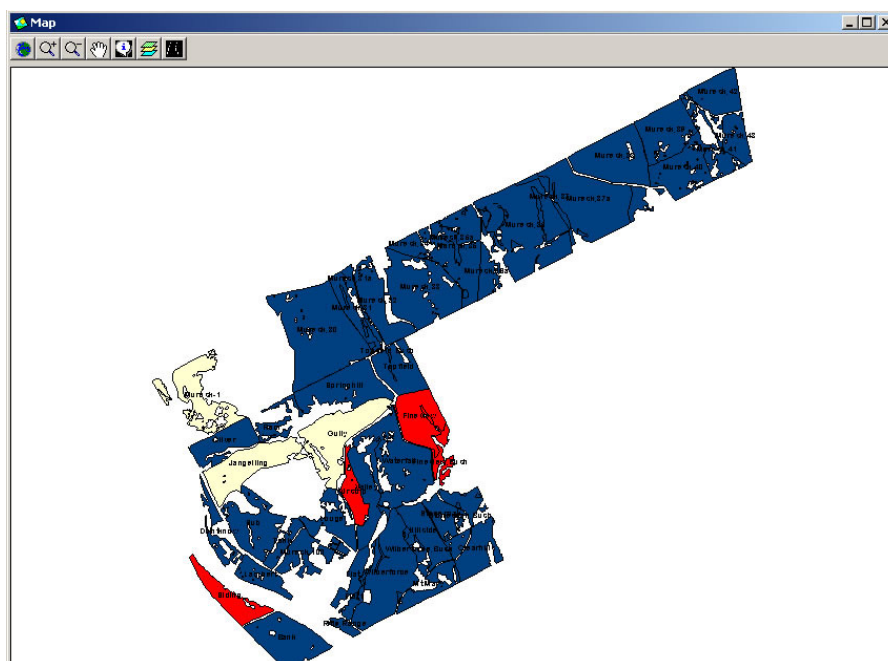

Figure 4.58 A map sample showing the whole-farm land-use management result

#### 4.6 Software Design, Databases and User Interface

*MOLup* was developed using Visual Basic 6 (Microsoft 2003) and ESRI MapObjects (ESRI 1999). It consists of three main modules: initial parameterisation, processing and output. In the first module, the user initialises all parameters required by *MOLup* (see Section 4.2). The second module includes the input stage and assessing paddock management options (see Section 4.3), as well as the search stage and optimisation stages respectively (see Section 4.4). *MOLup* then presents the result which allows for the user to dynamically select a suitable whole-farm land-use management plan based on their preferences (see Section 4.5).

##### 4.6.1 Databases

The model is based on an object-oriented approach where each aspect of whole-farm land-use plan is an object of *MOLup* (Figure 4.59): crop production yield, weather, crop price, spray/fertiliser, the farm, farm production and supplement information.

Each object is represented by one database. The functionality of each of the databases is as follows:

- Weather - current rainfall and the probability/possibility occurrence values of different season types;
- Crop yield - crop production derived from the crop production simulator;

- Spray and fertiliser database - all the fertiliser and chemicals used in the spraying. The fertiliser attributes stored basic attributes of the fertiliser, its nutrient level, as well as the emission factors caused by the individual nutrient. The chemical attributes stored include the basic attributes of the chemical, chemical type (i.e. herbicide and insecticide), the active ingredients of the chemicals, as well as, the level of active ingredient in the chemical and the possible environmental effects that may be caused by the chemical;
- Crop price - all current as well as historical market grain prices. It also records the current contract price given by the expert;
- The farm database stores all farm information, such as existing paddocks (and their current condition and history), farm capital, labor and other fixed cost. The farm database is unique for the individual farm considered;
- The farm production database is generated to store all the characteristics of the farm's production activities and generally acts as additional storage for the farm database;
- The info database stores all the additional attributes required for *MOLup*. The stored data includes: the crop attributes, machinery attributes, crop product attributes, soil attributes and other complementary information.

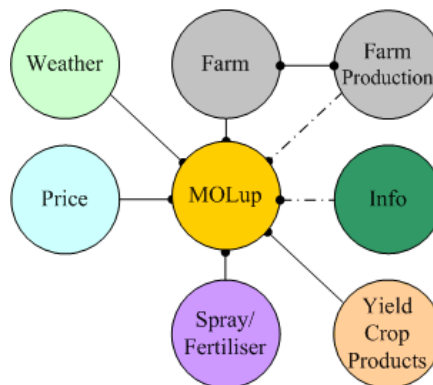

Figure 4.59 *MOLup* objects

#### 4.6.2 Libraries

*MOLup* uses a number of different dynamic-link libraries (DLL). These DLLs are software components that are linked during run-time. The libraries contain all methods and properties that can be updated and reused easily. Some of the libraries were provided by Microsoft, including:

- Microsoft ActiveX Data Object 2.7 Library;

- Microsoft ActiveX Data Object Recordset 2.7 Library;
- Microsoft OLE DB Simple Provider 1.5 Library;
- Microsoft ADO Extension 2.7 for DDL and Security Library;
- Microsoft Jet and replication Object 2.6 Library.

In addition, within *MOLup* there are a number of routines that are grouped into libraries depending on their functions, and constitute “private” DLL libraries, namely:

- *ADO Class Library*: The ADO class library contains procedures for managing the database including querying, interrogating, updating and deleting data from a table. This is a crucial library as *MOLup* is heavily based on database processes. Currently, MS Access is utilised as the database environment. Nevertheless, as the size of the database and technology progresses there is a possibility of utilising other database environments. Furthermore, the ADO class library can be reused when there are future changes on the database environment without any additional work;
- *Formatting Class Library*: The format class library contains procedures that perform all data formatting in *MOLup*. The library is arranged to ensure that all data input and output are in the correct format;
- *GetList Class Library*: This library incorporates all procedures that acquire all of the listed information, such as the selected land-use management options.

#### 4.6.3 *MOLup* user interfaces and facilities

*MOLup* has been developed to be user-friendly. The user is able to create a new farm model (see Section 4.6.3.1), use existing data (see Section 4.6.3.2) and reopen old results (see Section 4.6.3.3) (Figure 4.60).



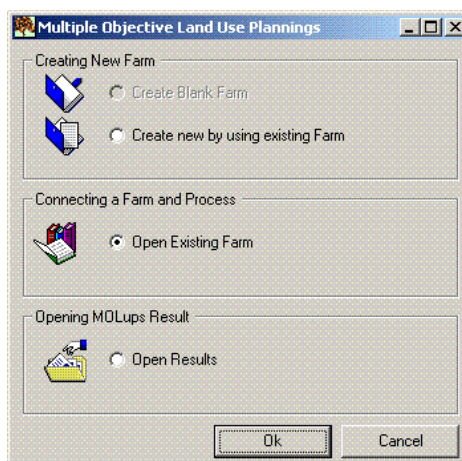
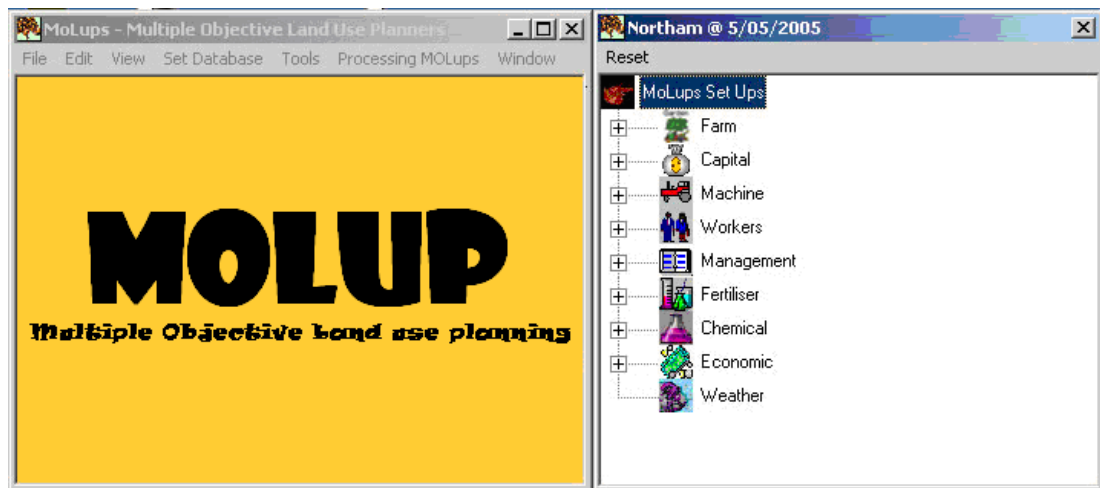

Figure 4.60 *MOLup* opening dialog box

The main screen interface has the following criteria (see Figure 4.61):

- *File*: This menu allows the user to open an existing farm platform, create a new one, save and open the output results, reset the model, connect it to a working folder and exit;
- *Edit*: This menu allows editing of farm attributes, such as farm paddock and crop attributes, commodity market information, soil attributes, fertiliser and pesticide properties, farming activities, simulation date and parameter settings;
- *View*: This menu option allows the user to view the settings and dataset utilised by *MOLup* in its simulation process;
- *Set Databases*: This menu option allows the user to link all of the required *MOLup* databases, namely (see Figure 4.59): market, fertiliser and pesticide, weather and crop production databases;
- *Tools*: This menu option allows a user to perform the forecasting of crop production based on the weather condition. Within this menu, *MOLup* also provides an additional facility that allows the restriction of some land-use management variables on different paddocks;
- *Simulation*: This menu contains all menus for running the *MOLup* main processes.

Some of these menus and facilities are only available in different *MOLup* modes. Figure 4.62 illustrates a general link between the *MOLup* mode, *MOLup* facilities and *MOLup* results.

Figure 4.61 *MOLup* main control

The first mode generates the farm settings. The second allows the farm settings to be edited, crop production and environmental impact to be simulated for specific weather conditions, and constraints set to obtain the most suitable whole-farm management options. The third mode allows old results to be re-opened and manipulated to draw out valuable information from the results saved in the second mode (Figure 4.62). Working examples of the menus and facilities are shown progressively in the next few sections along with the descriptions of *MOLup* processing modes.

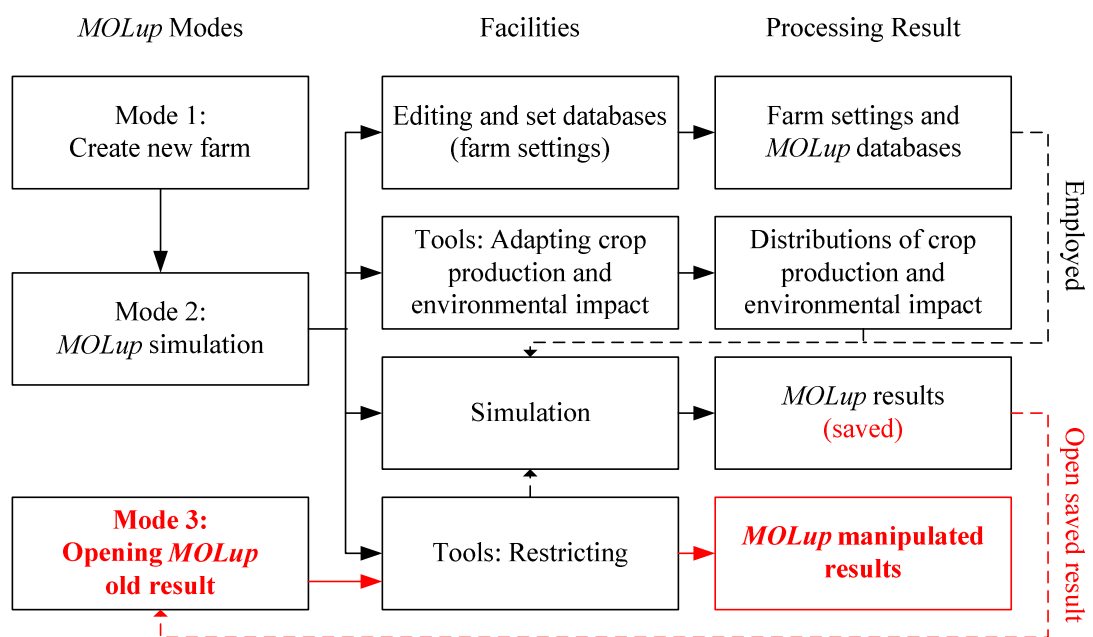
Figure 4.62 *MOLup* system

#### 4.6.3.1 First mode: creating a new farm planning scenario

This mode allows the user to create a new farm using two different pathways: blank setting, or by using existing farm settings (see Figure 4.60). The current prototype lacks the facility for setting a blank farm. Therefore, this particular setting will not be explained further in this thesis. On the other hand, the creation of a new farm database by using an existing farm setting requires the user to choose the existing farm (folder) and specifying a new farm name (see Figure 4.63). In addition, once the new farm has been generated, *MOLup* will directly connect the system to the newly created farm and into the second mode (see Section 4.6.3.2).

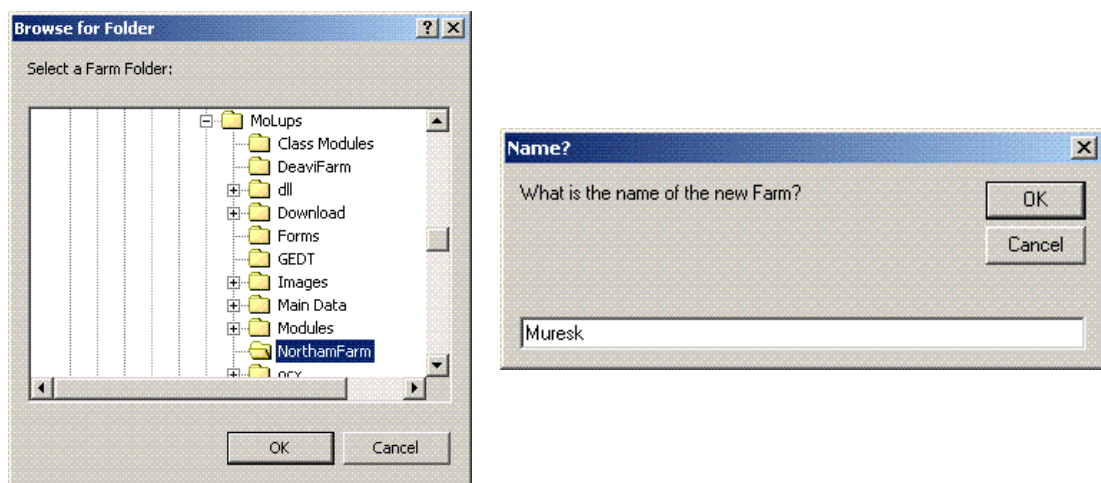

(a) Choosing an existing farm

(b) Specifying a new farm name

Figure 4.63 Creating a new farm setting by using existing farm data

#### 4.6.3.2 Second mode: connecting an existing farm planning scenario

*MOLup*'s second mode is where the simulation processes are performed. This can be done by choosing the *Open Existing Farm* (see Figure 4.60) option by using *File>Get existing farm* from the *MOLup* main menu (see Figure 4.64).

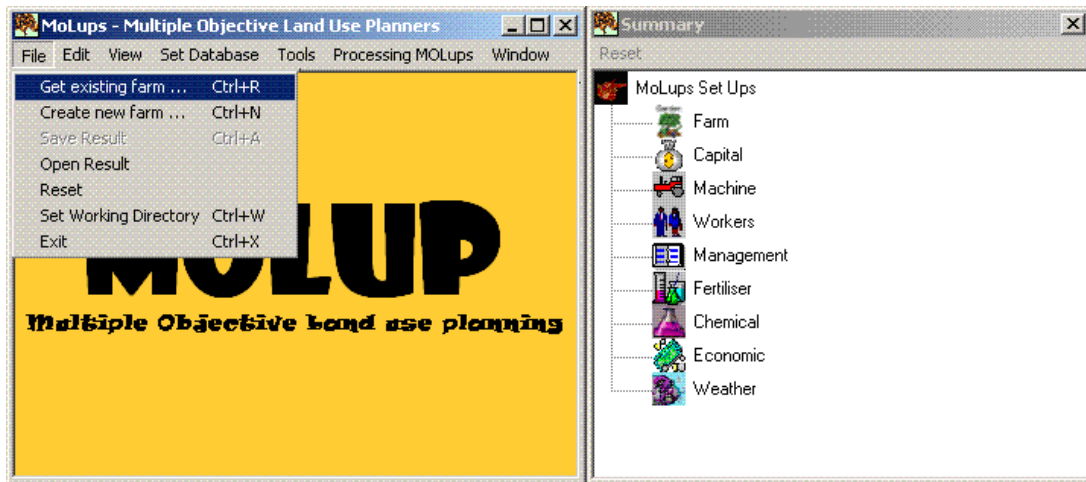
Figure 4.64 *MOLup* main page

In this mode, the user is able to use most of the *MOLup* facilities and menus (as stated in Section 4.6.3). One of these is the editing menu. In this case, the user is able to directly edit the data within the database via a dialog box provided by *MOLup*. Figure 4.65 illustrates one of the editing dialogs where farm details such as crop, paddock and soil attributes for each paddock can be updated.

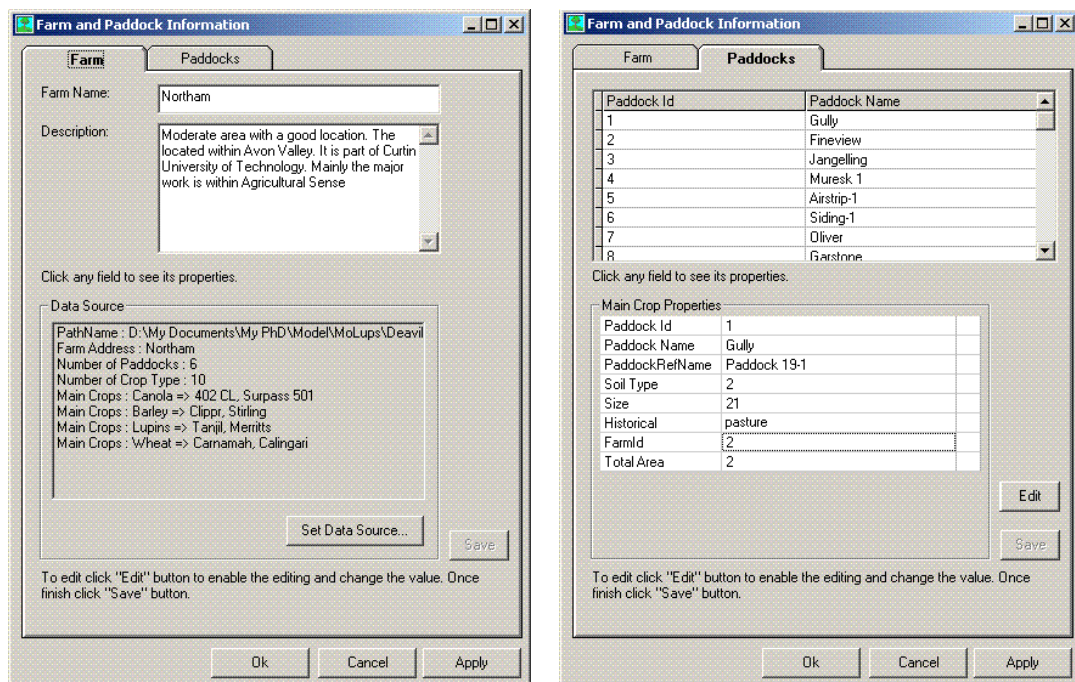

Figure 4.65 Example of updating a screen of a farm

Prior to running the simulation, all databases have to be linked to the *MOLup* system. In this case, *MOLup* provides a set menu which helps in linking all databases (see Figure 4.66).

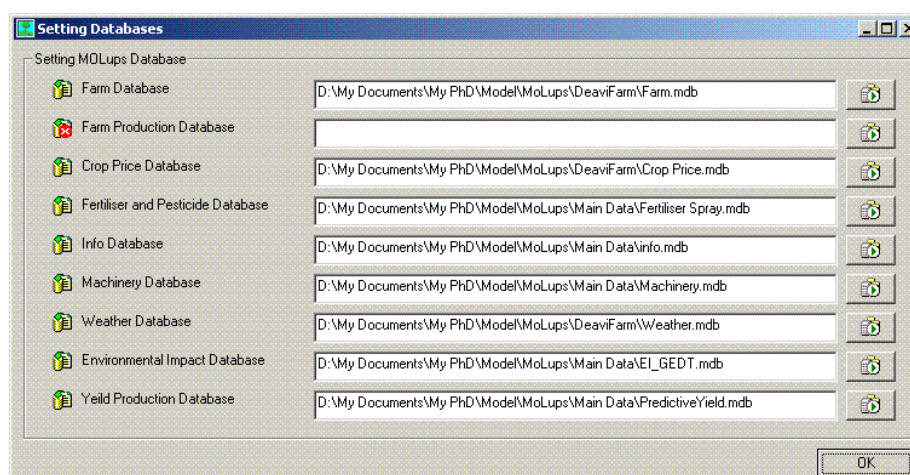

Figure 4.66 Setting databases

Another pre-processing requirement prior to the simulation process is to determine the most suitable whole-farm management options, the crop production and environmental data that needs to be pre-processed based on weather conditions at the decision point (Figure 4.67). As mentioned in Section 4.3.4, crop production is based on the farm's rainfall data. Subsequently, historical rainfall and current rainfall data are employed to determine the potential crop production and environmental impact (see Figure 4.67).

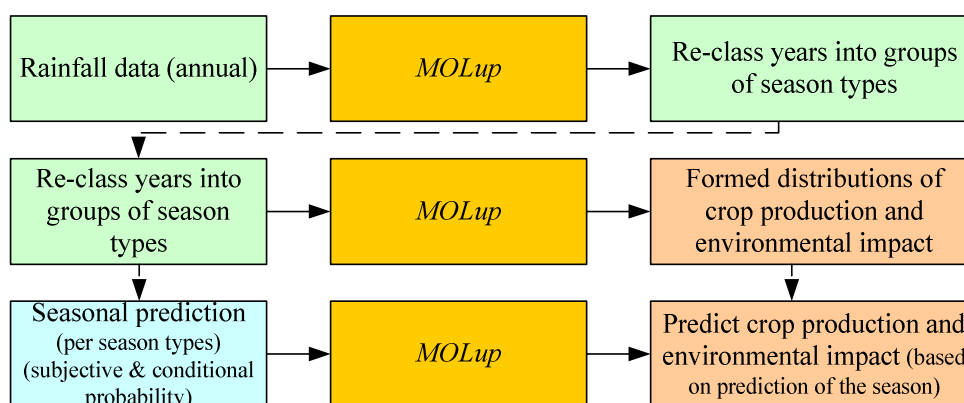

Figure 4.67 Pre-processing rainfall data to predict crop production and environmental impact distribution

The processes for predicting crop production is based on historical and current rainfall data. The process follows three distinct steps, as shown in Figure 4.68:

- Step 1 - Adapting crop production and environmental impact based on different season types (see Section 4.3.4.2). This process can be done by utilising *Tool>Adapt Step 1. Set Criterion Rainfall and Classify*. The historical rainfall



data are pre-processed to group the years into different classes based on their seasonal types. A working sample of this can be found in Section 5.2;

- Step 2 - The classification is then used to label crop production and environmental impacts of different land-use management into different groups based on season types and form yield production and environmental impact distributions based on the season types (see Section 5.2). This process can be performed by using *Tool>Adapt Step 2. Set Yield Production and Environmental Impact Distribution*. A working sample of this can be found in Section 5.3;
- Step 3 - The next process is for predicting crop production and environmental impact, either by using the current rainfall data or a subjective possibility of the occurrence of the seasonal type (see Section 4.3.4.3). The process can be performed by using *Tools>Adapt Step 3. Predict Crop Production*. A working sample of this can be found later on in Section 5.3.

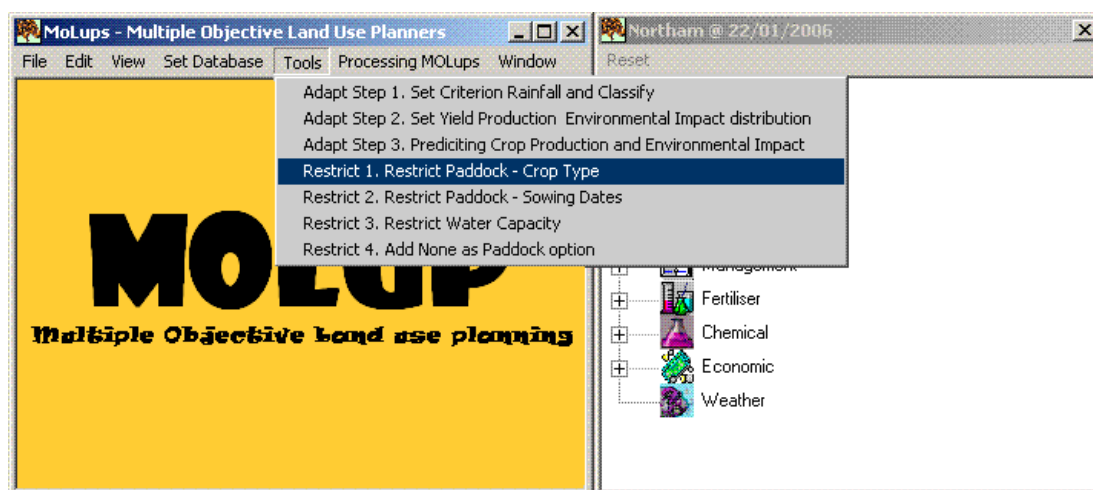

Figure 4.68 Menu for pre-processing historical rainfall to adapt crop production and environmental impact

Additionally, *MOLup* also provides a set of restriction tools to control a number of land-use management elements, such as crop type and initial soil water content. These restriction tools are as follows (Figure 4.68):

- Crop type - this allows the user to restrict a paddock to a certain crop type;
- Sowing date - can be set;
- Water holding capacity - sets the initial soil water level before sowing can begin;
- Fallow - allows a paddock to be fallowed for that season.

Once the crop production and the environmental impact have been adapted to the current weather condition, the simulation is ready to run. The overall *MOLup* processes are fashioned into four main stages (see Figure 4.69): *Set Parameters*, *Set Paddock LuMs*, *Set Whole-farm LuMs* and *Determine Pareto Optimisation*

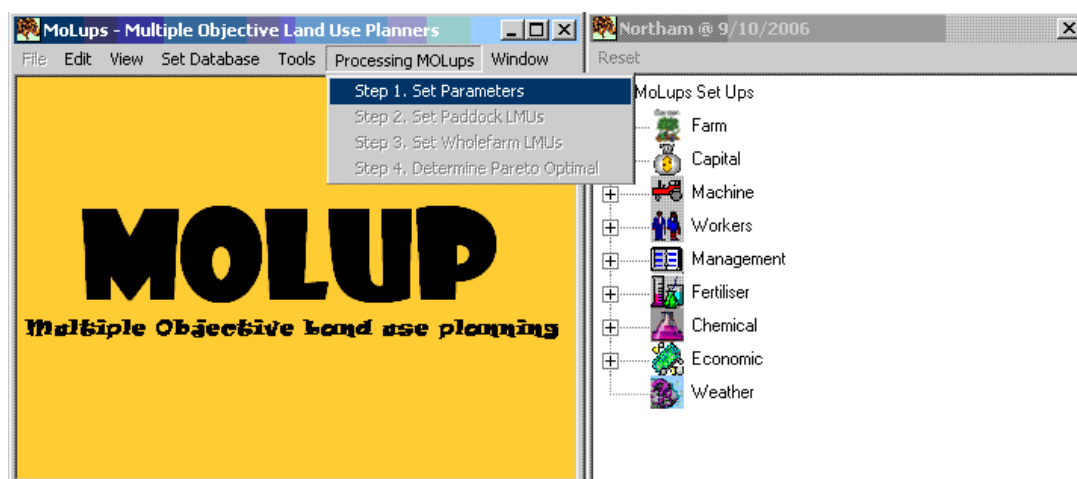

Figure 4.69 *MOLup* processes

Initially the user needs to set a number of parameters and initial criteria: paddock condition (see Section 4.2); whether the production is contracted or not (see Section 4.4.1.2 for explanation); set the *Pareto Optimisation* as part of the heuristic setting (the default setting is to use *Pareto Optimisation*; determining the number of iterations for Monte Carlo simulation, (the default value is 1000) (see Section 4.3.3 for explanation); set a threshold P-value for production distribution (the default value is 0.5) (see Section 4.3.2 for explanation); and other minor settings, such as allowing a paddock to be followed excluding land-use management options with negative gross margins.

The current condition of the paddock also needs to be established. This includes all the farming activities that have occurred prior to the decision date, such as paddocks sown, sowing date and fertiliser applications (at sowing time and four weeks later) and initial soil water availability during sowing time (see Figure 4.6 for a sample).

Market Assessment		Estimated Spot Price		Current Contract Price	
<b>Canola</b>					
<input checked="" type="checkbox"/>	387.04	10.48	<input type="checkbox"/>	337	
<b>Barley</b>					
<input checked="" type="checkbox"/>	165.94	15.24	<input type="checkbox"/>	208	
<input checked="" type="checkbox"/>	135.72	10.83	<input type="checkbox"/>	177	
<b>Lupins</b>					
<input checked="" type="checkbox"/>	160.47	8.02	<input type="checkbox"/>	175	
<b>Wheat</b>					
<input checked="" type="checkbox"/>	185.72	11.29	<input type="checkbox"/>	226	
<input checked="" type="checkbox"/>	186.85	10.89	<input type="checkbox"/>	202	
<input checked="" type="checkbox"/>	185.85	11.00	<input type="checkbox"/>	188	
<input checked="" type="checkbox"/>	230.37	16.01	<input type="checkbox"/>	169	
<input checked="" type="checkbox"/>	227.49	19.86	<input type="checkbox"/>	200	

Figure 4.70 A sample of the commodity price dialog box

In this initialisation stage, the user also needs to state the preferred selling method. As mentioned previously, for the purpose of this research, only two methods are used: the spot market and contract price (Figure 4.70).

In the second step, *MOLup* runs the simulation processes to evaluate and estimate the value of all paddock land-use management options. This process is followed by a heuristic process where each paddock's optimal land-use management are determined.

The pre-selected paddock land-use management option is then used to derive a whole-farm land-use management. The whole-farm production is evaluated based on each crop type, while the gross income is obtained by using the estimated crop price in turn is used to obtain the overall profitability. At the same time, the environmental impact associated with each paddock's land-use management is aggregated to obtain the whole-farm environmental impact.

In the last step, the multiple objective value of all whole-farm land-use management options is determined using *Pareto Optimisation* to form the *Pareto Front*. The *Pareto Front* is a set of whole-farm land-use management solutions, which are not



dominated by any other solution as result of comparing its profitability or its environmental impact with other management options.

#### 4.6.3.3 Third mode: opening *MOLup* farm planning scenario's old results

Once the simulation processes are finalised, the results can be saved into another file, which can be accessed again as necessary (see Figures 4.60 and 4.64 respectively).

In this mode, *MOLup* only provides a limited number of facilities to manipulate and draw out the necessary information from the old result. One of the facilities provided restricts paddocks from the assigned solutions with specific criteria. For example, allowing the user to restrict crop type alternatives for a certain paddock (Figure 4.68).

## 4.7 Chapter Summary

This chapter gives a comprehensive description of a prototype Land-use Decision Support System developed for this research, called *MOLup*. It recommends the most satisficing combinatorial set for the management of individual paddocks and a whole-farm mode based on trade-offs between two major objectives: maximising the whole-farm profit and minimising the environmental impact associated with the land-use in each paddock and aggregated to a whole-farm basis.

The model is an implementation of the *á Posteriori* optimisation approach, which is based on a search and select approach, where *Exhaustive Search* and *Pareto Optimisation* are used. In addition, Monte Carlo is integrated into the model to incorporate the uncertainty within land-use planning decision. The model is implemented as a stand-alone software package, employing both Visual Basic 6.0 and ESRI MapObjects OCX.

## CHAPTER 5

### CASE STUDY

This chapter describes a case study of how *MOLup* can be applied as a farm decision support system. Real weather (rainfall) data (Section 5.2), soil characteristics (Section 5.3.1), input fertiliser (Section 5.3.3), crop production (Section 5.3) and market data (Section 5.4) have been used to estimate the most suitable whole-farm land-use plan based on two major objectives (Figure 5.1): maximising the whole-farm profit and minimising the environmental impact of the chosen farming system.

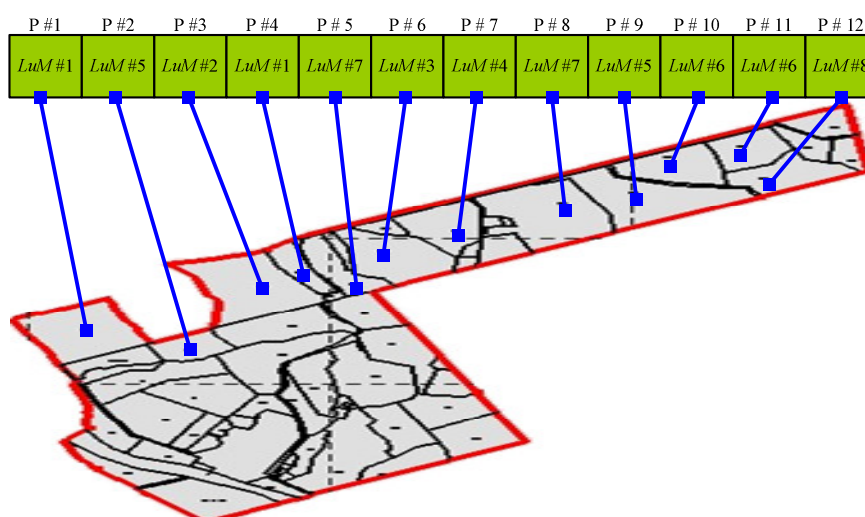

Figure 5.1 An example of the combinatorial set of land management paddocks for the Muresk farm

#### 5.1 Northam and Beverley

The case study farm is the 1720 ha Muresk Institute Farm, situated near Northam, Western Australia (Figure 5.2). Current farming enterprises include wheat, barley, oaten hay, canola, lupins and faba beans, Merino sheep, prime lamb and beef cattle production. The rainfall on the farm averages 450mm per annum and it experiences a Mediterranean climate. The soil type comprises 70% red loam and 20% grey sand, and the growing season is generally between May and September (MIA 2001).

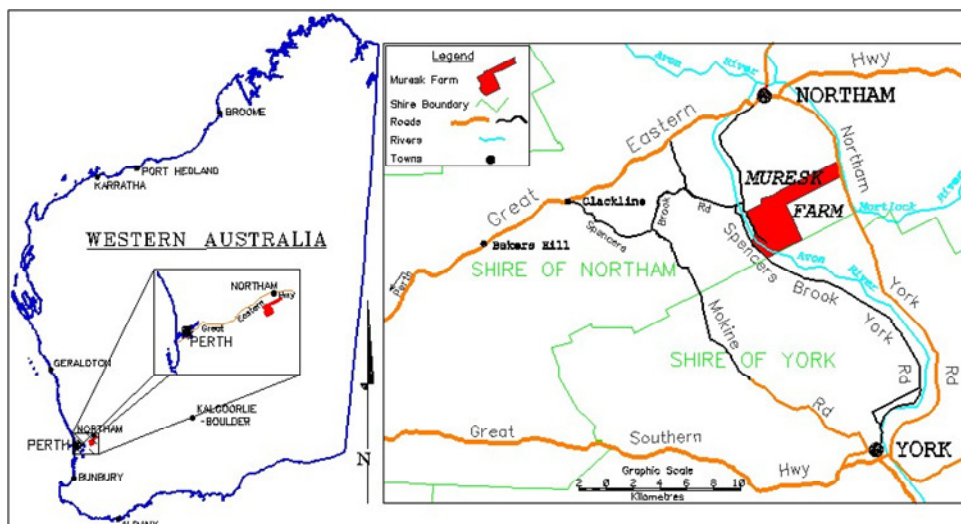

Figure 5.2 Muresk farm (Drysdale 2002)

WA Wheat data for Beverley was used to represent Muresk Farm crop production due to the lack of a crop simulator that was calibrated for Northam weather conditions. Beverley is located in the Avon Valley and is situated in the western central Wheatbelt region of Western Australia, some 138 km east from Perth and 68 km south of Northam. The average annual rainfall for the Beverley is 420.4mm (1886 - 2004) (Bureau of Meteorology 2004) which is slightly lower than the Muresk Farm but has a similar climate to Northam.

## 5.2 Northam Weather - Rainfall Data

The rainfall data used in this study has been recorded at the Northam weather station, maintained by the Department of Agriculture and Food, Western Australia. The data set comprises 86 years of monthly rainfall recordings from 1920 until 2005.

As mentioned previously (see Section 4.3.4.2), eight season types have been categorised based on three rainfall criteria; namely summer rain, early season rain and annual rain. The summer rain is the accumulated rainfall within the first three months of the year, while the early season rain categorises the total rain for the two months after summer ends (i.e. April-May) and the annual rain is the total accumulated rainfall within a year. The statistical information based on summer rain, early rain and annual rain at Muresk can be seen in Table 5.1 and the histogram can be viewed in Figure 5.3. In general, the histogram shows that Muresk has a normally distributed annual rainfall pattern.

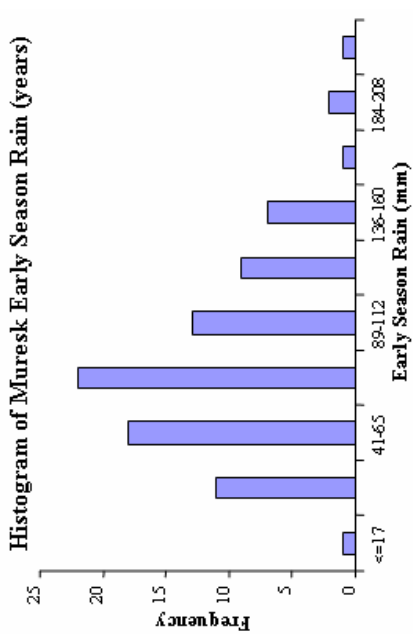

(b) Early Season (April -May) Rain (mm)

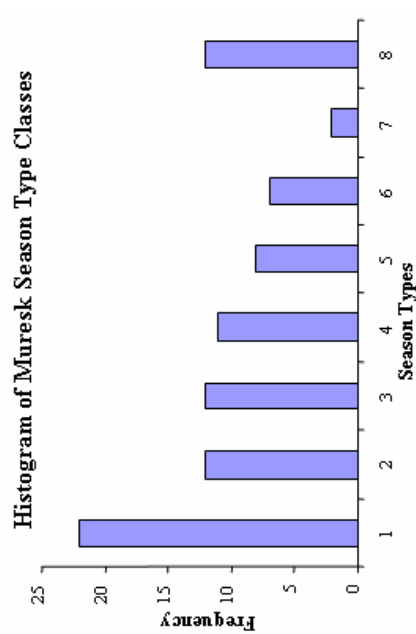

(d) Muresk rainfall data based on season types

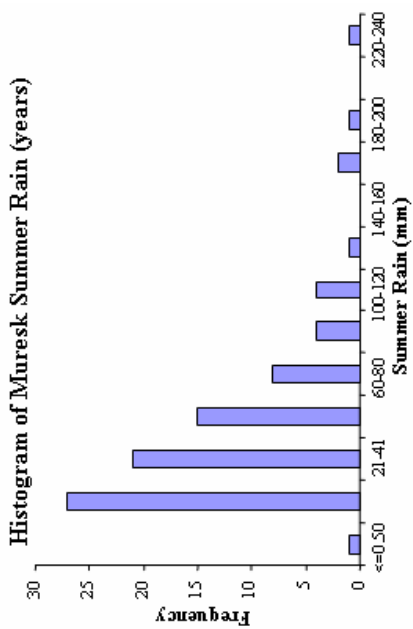

(a) Summer (January-March) Rain (mm)

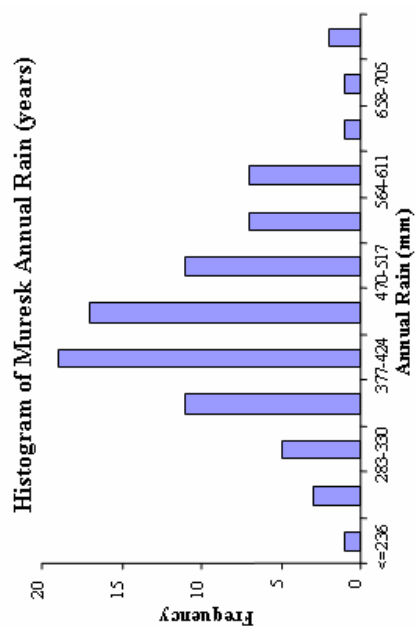

(c) Annual Rain (mm)

Figure 5.3 Histograms of Muresk rainfall by season type

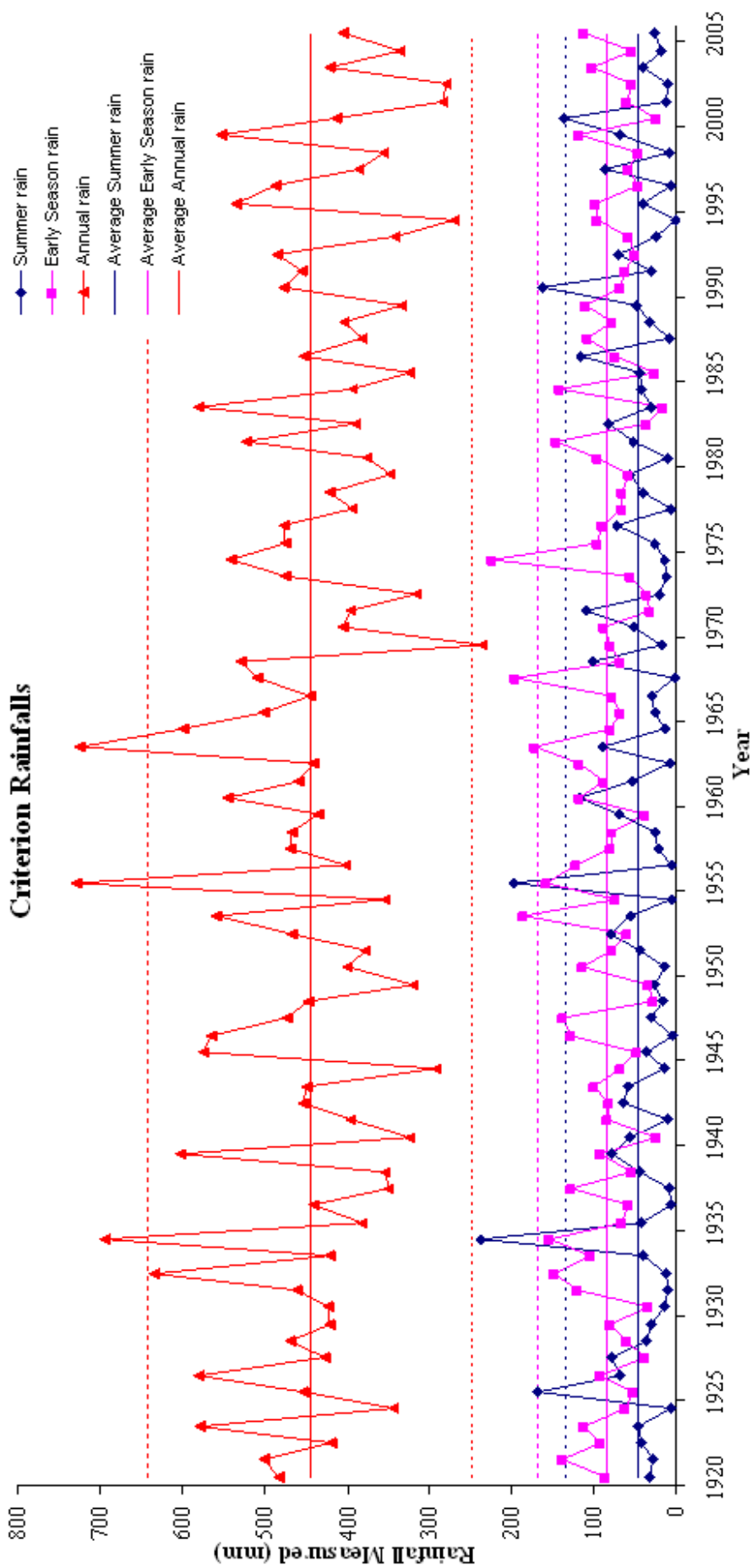

Figure 5.4 Muresk rainfall; the dotted lines represent two standard deviations from the mean

The summer rain (i.e. rainfall from January until March) ranges from 0.50mm up to 238.2mm with an average of 45.59mm and a median of 32.1mm (Table 5.1). The considerable differences in the average and median summer rain suggests the summer rain is not normally distributed (shown in the summer rain histogram in Figure 5.3a) and may be due to a number of exceptionally high rainfall years (i.e. 1925, 1934, 1955 and 1990) (Figure 5.4). If the outliers are excluded, the average summer rainfall drops to 37.30mm with a standard deviation of 28.76mm.

Table 5.1 Statistical information of Muresk rainfall (1920-2005)

Statistical Description	Summer Rain Jan - Mar (mm)	Early Rain Apr - May (mm)	Annual Rain Jan - Dec (mm)
Minimum	0.50	16.90	236.20
Maximum	238.2	223.60	727.50
Average	45.59 (37.30*)	84.77	444.61
Standard Deviation	44.47 (28.76*)	41.34	98.73
IQR 1	13.98	57.30	382.90
Median	32.10	79.20	440.90
IQR 3	57.90	109.80	485.88
<i>Summer Rain</i>	<i>1</i>	<i>0.031</i>	<i>0.424</i>
<i>Early Season Rain</i>	<i>0.031</i>	<i>1</i>	<i>0.478</i>
<i>Annual Rain</i>	<i>0.424</i>	<i>0.478</i>	<i>1</i>

Note: the correlation matrix is set in italics; \*outliers excluded

The early season rain ranges from 16.9mm up to 223.6mm with an average of 84.77mm and a median of 79.20mm (Table 5.1). A number of years fall outside the range of the 95% confidence interval (i.e. 1953, 1963, 1967 and 1974, see Figure 5.4). For early season rain, the histogram and statistical results show that rainfall is reasonably normally distributed with a slight skew to the left (Figure 5.3b). For most years, the early season rain ranges from 16.9mm to 155.00mm. Moreover, further statistical analysis shows a lack of correlation between the summer rain and early season rain,  $r = 0.031$  (see correlation matrix in Table 5.1). This indicates that it is impossible to determine early season rain based on the summer rainfall data.

Additionally, the annual season rainfall ranges from 236.20mm to 727.50mm with an average of 444.61mm and a median of 440.90mm (Table 5.1). The rainfall pattern shows a fairly normal distribution with a slight skew to the left (Figure 5.3c). There are three years when the annual rainfall was exceptionally high (i.e. 1934, 1955, and 1963). This may be correlated with the high summer and early season rainfall of those years (see correlation matrix in Table 5.1). The correlation matrix in Table 5.1

shows a slight correlation between annual and summer rainfall and between annual and early season rainfall, which in turn indicates that summer rain and early season rain may be used as a possible signal of the total annual rainfall.

Table 5.2 Classification of Muresk rainfall (1920-2005)

Season Type	Average of <i>Criterion</i> Rainfall (1920-2005)			Years (totalled 86 years)
	Summer	Early Season	Annual	
1 (dry all year round)	≤45.59	≤84.77	≤444.61	22
2 (dry summer and early season, and wet annually)	≤45.59	≤84.77	>444.61	12
3 (dry summer, wet early season and dry annually)	≤45.59	>84.77	≤444.61	12
4 (dry summer, wet early season and annually)	≤45.59	>84.77	>444.61	11
5 (wet summer, dry early season and annually)	>45.59	≤84.77	≤444.61	8
6 (wet summer, dry early season and wet annually)	>45.59	≤84.77	>444.61	7
7 (wet summer and early season, and dry annually)	>45.59	>84.77	≤444.61	2
8 (wet all year round)	>45.59	>84.77	>444.61	12

Table 5.2 displays relationships between season type for the Muresk rainfall data over 86 years (i.e. 1920 - 2005), based on average *criterion* rainfall data. It shows that Muresk generally has a dry summer (i.e. lower and equal to average summer rainfall), and in particular season type 1. Additionally, it is rare that a dry year develops when the year begins with a wet summer and early season (i.e. categorised as season type 7). Nevertheless, it must also be noted that unseasonable and extreme rainfall may influence average *criterion* rainfall. For example, it was stated above that the filtering out of outliers for summer rainfall reduced the average summer rainfall from 45.59mm to 37.30mm, which in turn may change the rainfall category and Muresk's seasonal classifications.

Figure 5.5 and Table 5.3 show that in the summer of 2006, the first two months of the year were exceptionally wet, followed by very low rainfall in March. Accordingly, the high rainfall during the first two months was an exceptional summer rainfall when compared to the records (i.e. except for 1955, when the total summer rainfall amounted to 196.9mm).

In April 2006, the rainfall almost reached the average monthly rainfall for April. However in the following three months, the rain was exceptionally lower than the

usual monthly rainfall for the area, although the August rainfall reached a slightly higher than usual monthly average (see Figure 5.5). The lack of rainfall in May caused an extremely low early season rainfall. From the rainfall data, it can be concluded that 2006 may fall into the category of having a high summer rainfall but with low early season rain. However, at the time of conducting this analysis (i.e. October 2006) the annual rainfall was unavailable.

Table 5.3 Monthly rainfall in 2006 and the average monthly rainfall

Month	2006 Rainfall	2006 <i>Criterion</i> Rainfall	Average Rainfall	Average of <i>Criterion</i> Rainfall (1920-2005)
January	136.9	<b>2006 Summer rain: 172.6mm</b>	12.06	<b>Summer rain: 45.59mm</b>
February	35.3		14.67	
March	0.4		18.86	
April	21.3	<b>2006 Early season rain: 33.9mm</b>	23.82	<b>Early season rain: 84.77mm</b>
May	12.6		60.94	
June	17	<b>2006 Annual rain (*until 10 Sep): 360mm</b>	86.94	<b>Annual rain: 444.61mm</b>
July	37.5		84.13	
August	65.6		60.38	
September	33.4*		35.89	
October	Unknown		24.67	
November	Unknown		13.04	
December	Unknown		9.18	

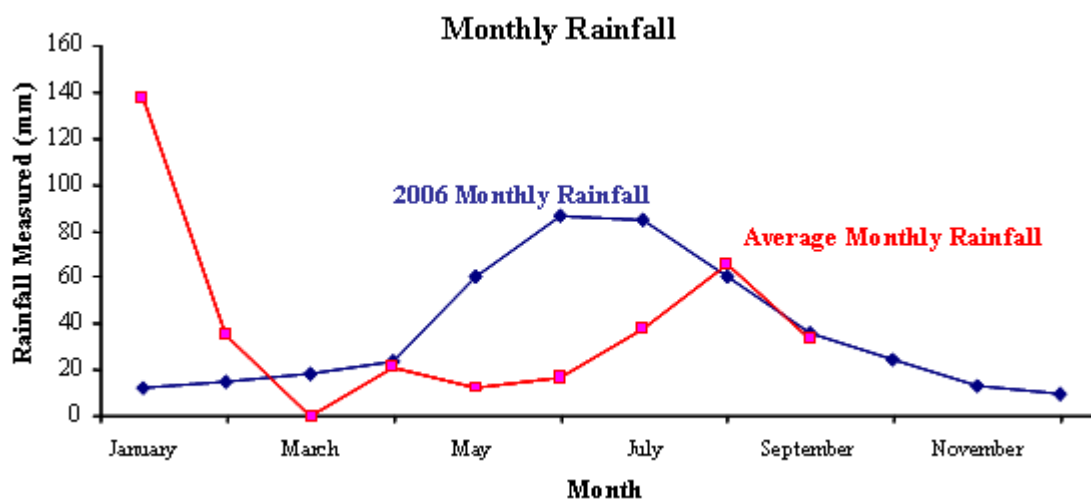

Figure 5.5 2006 monthly rainfall versus Average monthly rainfall (1920-2005) (only up to October 2006 data available at point of analysis)

The change of a farmer's confidence on the type of growing season as the year progresses can be seen as the following (see Figures 5.5, 5.6 and 5.7, Tables 5.2 and 5.4):

- January-March 2006: at the beginning of the year, the farmer can only rely on the historical weather data to plan that year's cropping program and, accordingly, the



prediction will be based on the conditional probability derived from that data (Table 5.4 - January) (see Section 4.3.4.3.1 for details). The accumulated January 2006 rainfall shows a very wet month, with a total rainfall of 136mm, which is above average (see Figure 5.5). Furthermore, at the end of February 2006, the rainfall accumulated since the beginning of the year was 172.6mm. Since the average summer rainfall was only 45.59mm, by the end of February a farmer can confidently eliminate half of the season types as seasons “impossible” to occur (see Table 5.4 - February). Additionally, the summer period has ended with the total summer rainfall of 172.6mm (see Table 5.3), which in turn is the parameter used to calculate the conditional probability of different season types (Table 5.4 - March and Figure 5.7a);

- April-May 2006: The summer rain concludes in March and the early season period begins in April. April’s rainfall totals 21.3mm, which almost equates to the average April rainfall of 23.8mm (see Table 5.3). Accordingly, the May rainfall needs to reach 63.47mm to ensure that the early season rain will be able to reach the average early season rainfall. Based on the historical data, for the years with summer rain above 45.59mm (i.e. 29 years meet this criterion), 11 have a May rainfall approaching 63.47mm (see Figure 5.7b). This shows that although there is a good possibility (i.e.  $11/29 = 37\%$ ) that the rainfall of May 2006 reaches the required amount of 63.47mm to achieve the early season threshold level, a large possibility also exists that such a threshold will not be met. Therefore, some of the season types can be filtered out based on the subjective and logical deduction process (Table 5.4-April). May rainfall is disappointingly low at 12.6mm. As such, based on the summer rain and total early season rain criteria (at the end of May), most season types are filtered out leaving only two season types (i.e. type five or six) (Figure 5.7c);
- June - September 2006: By mid September, the total annual rainfall has only reached 360mm meaning that the accumulated rainfall from the middle of September to the end of 2006 needs to be at of least 84.61mm in order to reach the average threshold value of 444.61mm. Based on the analysis of historical data, only 4 out of 15 years show a rainfall of at least 84.61mm from the middle of September until the end of the year. This indicates a small possibility (i.e.  $4/15 = 27\%$ ) that the annual rainfall of 2006 is going to be greater than 444.61mm, given the summer (e.g. 45.59mm) and early season rainfall (e.g. 84.77mm).

Table 5.4 Weather changes constantly and uncertainty surrounding season type narrows as the year progresses

Season Type	Jan	Feb	Mar	Apr	May	June	Jul	Aug	Sep
1 (dry all year round)	0.26	Impossible	0	Impossible	0	Impossible	Impossible	Impossible	Impossible
2	0.14	Impossible	0	Impossible	0	Impossible	Impossible	Impossible	Impossible
3	0.14	Impossible	0	Impossible	0	Impossible	Impossible	Impossible	Impossible
4	0.13	Impossible	0	Impossible	0	Impossible	Impossible	Impossible	Impossible
5	0.09	Likely to occur	0.28	Likely to occur	0.53	Likely to occur	Very likely to occur	Very likely to occur	Extreme likely to occur
6	0.08	Likely to occur	0.24	Likely to occur	0.47	Likely to occur	Neither nor likely to happen	Very unlikely to occur	Very unlikely to occur
7	0.02	Likely to occur	0.07	Neither nor likely to happen	0	Impossible	Impossible	Impossible	Impossible
8 (wet all year round)	0.14	Likely to occur	0.41	Neither nor likely to happen	0	Impossible	Impossible	Impossible	Impossible

Estimated of Occurrence Probability of a Season as the Year Progresses

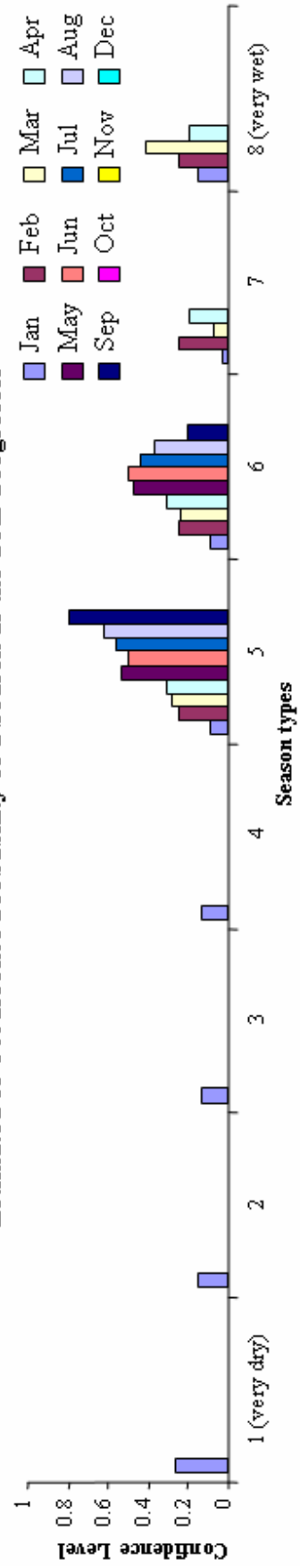

Figure 5.6 The estimated probability (confidence) of a season to occur as the year progresses

Figure 5.6 shows changes in the confidence level for predicting the season types as the year progresses (see also Table 5.4). As the year progresses, the supplementary data provide greater confidence on the season types. For example, Figure 5.6 shows that in January, the level of confidence that the year is going to be season type five is quite low; subsequently, as the year progresses the confidence level on season type five increases as more and more information is fed into the *MOLup* system.

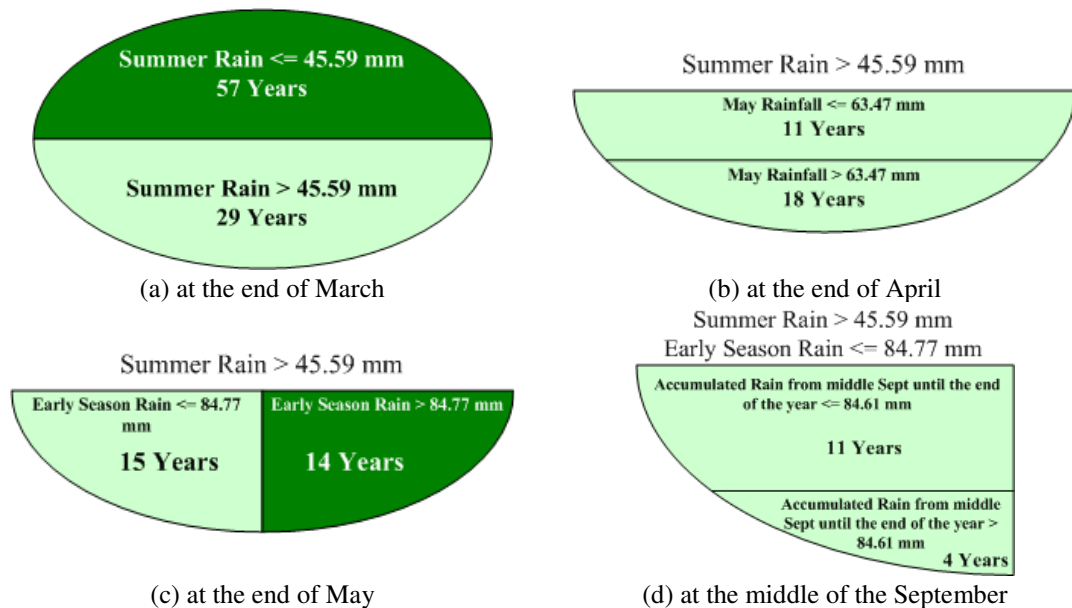

Figure 5.7 The filtering of season types as the year progresses

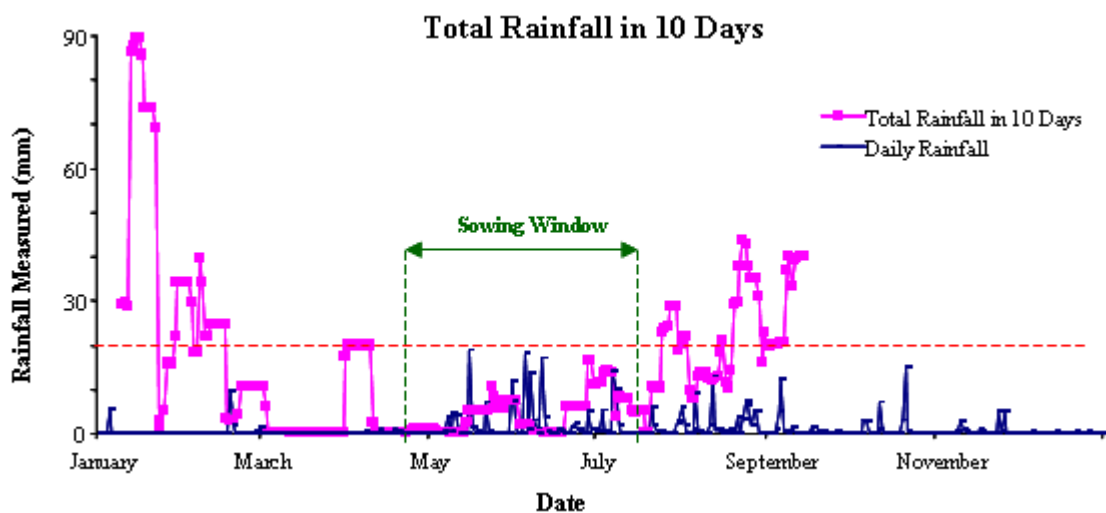

Figure 5.8 The total rainfall in 10 days versus daily rain of the year 2006

In general, the rainfall data are collected in daily or weekly formats, thus they need to be pre-processed for the monthly rainfall data required by *MOLup*. Additionally, for this particular case study, the break of the season implies that there is 20mm of rain

within a continuous period of 10 days at the start of the sowing window, which generally occurs in late April until early July (Figure 5.8). In addition, when there is 20mm of rain within 10 days, it is assumed that the initial soil water content has reached 50% of the soil water holding capacity, and signifies the break of season. Based on the data gathered, the break of the season for 2006 does not seem to occur. The time (during the sowing window) when the accumulated 10 days rainfall almost reached the 20mm is at the end of June (i.e. the 28<sup>th</sup> June 2006), when the cumulative value of 16.6mm over a ten day period was reached (Figure 5.8).

### 5.3 Crops production and Environmental Impact

*MOLup* utilises WA Wheat as the crop production ‘simulator’, which is based on a range of land-use management settings for 101 years (i.e. 1900 up to 2001). Since *MOLup* uses WA Wheat to predict crop production, the land-use management options utilised by *MOLup* are restricted to the land-use management settings provided by WA Wheat. The land-use management settings are restricted to the following:

- Soil Type: deep sandy duplex, yellow sandy earth and yellow deep sand (see Section 5.3.1);
- Crop Rotation: Pasture/wheat or continuous wheat;
- Crop Variety: Wheat Long and Wheat Short (see Section 5.3.2);
- Sowing Dates: 25 April, 10 May, 30 May, 5 June, 15 June and 5 July ;
- Fertiliser 1 (at sowing): 0, 30, 50 and 100 kg/ha of nitrogen;
- Fertiliser 2 (four weeks after sowing): 0, 30, and 50 kg/ha of nitrogen;
- Initial Soil water: None or 50% of capacity (see Section 5.2);
- Plants: 100 plants per square meter.

#### 5.3.1 Paddock and land management units

Soil variability across a paddock is very common in the WA Wheatbelt including the Muresk Farm. This means that farmers are required to either treat a paddock as homogenous or undertake additional expense to treat parts of paddocks differently. New precision farming technologies are now helping to reduce this additional cost. In this case study the concept of Land Management Units (LMU) rather than paddocks is used.

Table 5.5 LMU description (Warren 2007)

LMU Types	Major Characteristic of the Dominant Soil Type
LMU 1	<ul style="list-style-type: none"> <li>- Sandy loam A-horizons (7-13 cm) over sandy clay loam to light medium clay</li> <li>- Medium levels of organic carbon in the topsoil (1.3-1.7%)</li> <li>- Good capacity to store nutrient cations (ECEC 14.2-24.7)</li> <li>- Subsoils contain stones (8-17%)</li> <li>- Restricted depths (10-30 cm)</li> <li>- Neutral, Non saline soils</li> </ul>
LMU 2	<ul style="list-style-type: none"> <li>- Clayey sand A-horizons (8-14 cm) over sandy loam</li> <li>- Medium levels of organic carbon in the topsoil (1.1-1.6%)</li> <li>- Good capacity to store nutrient cations (ECEC &lt; 6.7)</li> <li>- Subsoils contain stones (7-20%)</li> <li>- Restricted depths (15-30 cm)</li> <li>- Neutral, Non saline soils</li> </ul>
LMU 3	<ul style="list-style-type: none"> <li>- Clayey sand A-horizons (&lt; 3 cm) over sandy clay loam to medium clay</li> <li>- Medium levels of organic carbon in the topsoil (1.0-1.7%)</li> <li>- Medium to good capacity to store nutrient cations (ECEC 7.0-24.2)</li> <li>- Subsoils contain stones (7-17%)</li> <li>- Restricted depths (10-20 cm)</li> <li>- Neutral, Non saline soils</li> </ul>
LMU 4	<ul style="list-style-type: none"> <li>- Sandy loam A-horizons (5-12 cm) over sandy clay loam to light medium clay</li> <li>- Some subsoils slightly saline (EC1: 5 7-20 mS/m)</li> <li>- Medium levels of organic carbon in the topsoil (0.9-1.5%)</li> <li>- Medium to good capacity to store nutrient cations (ECEC 12.5-20.0)</li> <li>- Subsoils contain stones (6-16%)</li> <li>- Restricted depths at 30 cm</li> <li>- Some subsoils slightly sodic (pH ca 6.0-7.1)</li> </ul>
LMU 5	<ul style="list-style-type: none"> <li>- Loamy sand A-horizons (10-12 cm) over clayey sand.</li> <li>- Low level of organic carbon in topsoil (0.8-1.4%)</li> <li>- Poor capacity to store nutrient cations (ECEC &lt;4)</li> <li>- Subsoils contain stones (9-17%)</li> <li>- Restricted depths at 30 cm</li> <li>- Neutral, Non saline soils</li> </ul>
LMU 6	<ul style="list-style-type: none"> <li>- Loamy sand A-horizons (10-20 cm) over clayey sand</li> <li>- Medium levels of organic carbon in topsoil (1.0-1.4%)</li> <li>- Poor capacity to store nutrient cations (ECEC &lt;3.8)</li> <li>- Subsoils contain stones (3-8%)</li> <li>- Neutral, Non saline soils</li> </ul>
LMU 7	<ul style="list-style-type: none"> <li>- Clayey sand A-horizons (&lt; 3 cm) over clayey sand</li> <li>- Medium levels of organic carbon in topsoil (0.8-1.4%)</li> <li>- Poor capacity to store nutrient cations (ECEC &lt;6.7)</li> <li>- Subsoils contain stones (13-23%)</li> <li>- Some restricted depths at 30 cm</li> <li>- Neutral, Non saline soils</li> </ul>
LMU 8	<ul style="list-style-type: none"> <li>- Sand A-horizons (1-5 cm) over loamy sand</li> <li>- Low level of organic carbon in topsoil (0.7-1.1%)</li> <li>- Poor capacity to store nutrient cations (ECEC &lt;3.1)</li> <li>- Subsoils contain stones (6-10%)</li> <li>- Neutral, Non saline soils</li> </ul>
LMU 9	<ul style="list-style-type: none"> <li>- Loamy sand A-horizons (10-15 cm) - over clayey sand</li> <li>- Low level of organic carbon in the topsoil (0.8-1.1%)</li> <li>- Poor capacity to store nutrient cations (ECEC &lt;3.9)</li> <li>- Subsoils contain stones (12-22%)</li> <li>- Restricted depths (20-30 cm)</li> <li>- Neutral, Non saline soils</li> </ul>

LMU 10	<ul style="list-style-type: none"> <li>- Sand A-horizons depth (6-11 cm)</li> <li>- Low level of organic carbon in topsoil (0.7-1.1)</li> <li>- Poor capacity to store nutrient cations (ECEC &lt;4.0)</li> <li>- Restricted depths (&lt;20 cm)</li> <li>- Topsoils contain stones (5-7%)</li> </ul>
LMU 11	<ul style="list-style-type: none"> <li>- Sand A-horizons (10-15 cm) over sand</li> <li>- Low level of organic carbon in topsoil (0.6-1.0%)</li> <li>- Some subsoils slightly acidic (pH 4.7-5.3)</li> <li>- Poor capacity to store nutrient cations (ECEC &lt;2.3)</li> <li>- Subsoils contain stones (1-7%)</li> <li>- Non saline</li> </ul>

The LMUs were derived from a parallel study of the Muresk Farm undertaken by Warren *et al.* (2006), which used multivariate classification methods to define LMU boundaries. In this work, the Land Management Unit is defined as “an area of land, similar in terms of the physical characteristics and production capabilities that can be managed uniformly”. Figure 5.9 illustrates one of the outputs from this research where the Muresk Farm is aggregated into 11 different LMUs (see Table 5.5 for full description).

The WA Wheat model is based on three broad soil type classifications: deep sandy duplex, yellow deep sand and yellow sandy earth (see Table 5.6). It was therefore necessary to reduce the 11 LMUs to the three which the WA Wheat model uses. This was achieved using James Fisher’s expert knowledge<sup>2</sup>. Table 5.6 shows how the LMUs from the Warren *et al.* (2006) study have been aggregated to relate directly with the WA Wheat classification system.

---

<sup>2</sup> Note: James Fisher was a research officer at Department of Food and Agriculture WA in Northam where he was researching and developing activities to quantify the performance of agricultural systems in response to environmental impact. It was outside the scope of this research to further develop the WA Wheat model to account for eleven LMUs’ soil characteristics.

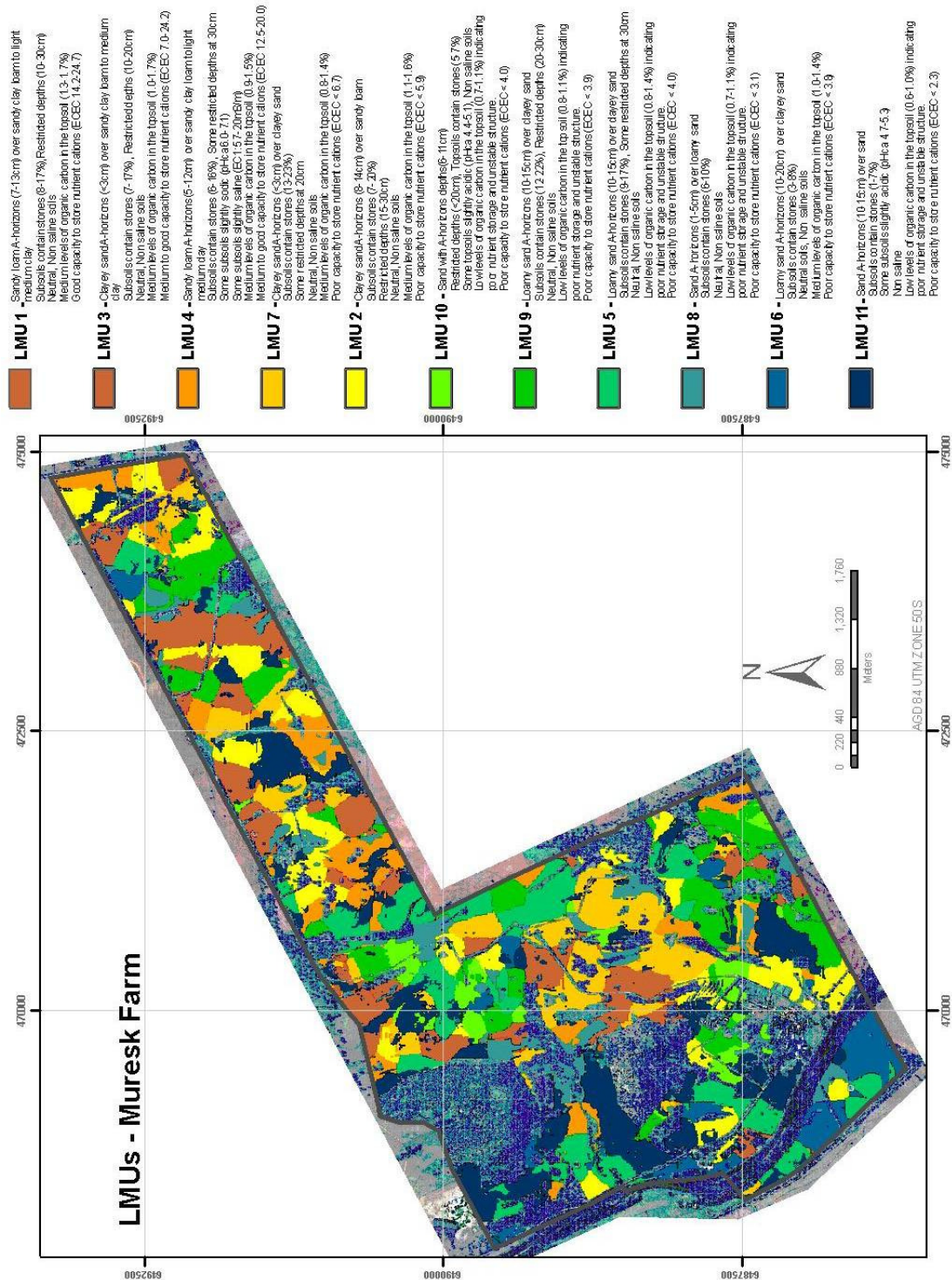

Figure 5.9 A sample of Land Management Unit analysis for the Muresk Farm; Source: Warren (2007)

Table 5.6 Aggregated LMU (Fisher, personal communication)

LMU Type	Soil Class	Soil Attribute Description
LMU 10 LMU 11	deep sandy duplex	Soil Group 403 (Schoknecht 2002) Max rooting depth = 70 cm PAWC (profile) = 154mm PAWC (rooting depth) = 76mm Root growth restrictions = clay at 40-50 cm; waterlogging Others: 1.3 %OC (0-10 cm); pH 4.9 (0-10), 5.1 (10-20)
LMU 1 LMU 3 LMU 4 LMU 7 LMU 2	yellow deep sand	Soil Group 446 (Schoknecht 2002) Max rooting depth = 150 cm PAWC (profile) = 137mm PAWC (rooting depth) = 77mm Root growth restrictions = nil
LMU 9 LMU 5 LMU 8 LMU 6	yellow sandy earth	Soil Group 464 (Schoknecht 2002) Max rooting depth = 230 cm PAWC (profile) = 160mm PAWC (rooting depth) = 145mm Root growth restrictions = nil Others: 0.083 %OC (0-10 cm); pH 4.9 (0-10), 5.1 (10-20)

Considering that the sizes of the land management units produced are mainly undersized in contrast with the usual paddock sizes, a number of LMUs with an analogous soil class are aggregated to form typical size paddocks with homogenous soil classes (i.e. the three soil classes as stated in Table 5.6).

In this case, a total of six out of the 44 Muresk farm paddocks were chosen, where the dominant LMU and associated soil class characteristics were identified for each paddock (see Table 5.7). For example, *Gully* was formed by three different LMU categories: LMU 3, LMU 4 and LMU 7 (Figure 5.10). Under the soil class utilised by WA Wheat, all LMUs are categorised as the yellow deep sand soil class. Therefore, *Gully* was selected and considered dominated by a homogenous yellow deep sand soil. The rest of the paddocks were selected using a similar approach. Table 5.7 illustrates the six paddocks chosen for this particular case study.

Table 5.7 Paddock summary information

Paddock	Paddock Name	Predominant LMU Types Within the Paddock	Soil Type	Size Ha	Previous Year Crop
Paddock 19	<i>Gully</i>	LMU 3, LMU 4 and LMU 7	Yellow deep sand	21	Pasture
Paddock 21	<i>Fine View</i>	LMU 5 and LMU 9	Yellow sandy earth	32	Pasture
Paddock 5	<i>Jangelling</i>	LMU 11	Deep sandy duplex	40	Pasture
Paddock 1	<i>Muresk-1</i>	LMU 11	Deep sandy duplex	39	Wheat
Paddock 16	<i>Airstrip</i>	LMU 3 and LMU 7	Yellow deep sand	12	Wheat
Paddock 12	<i>Siding</i>	LMU 5 and LMU 6	Yellow sandy earth	23	Wheat



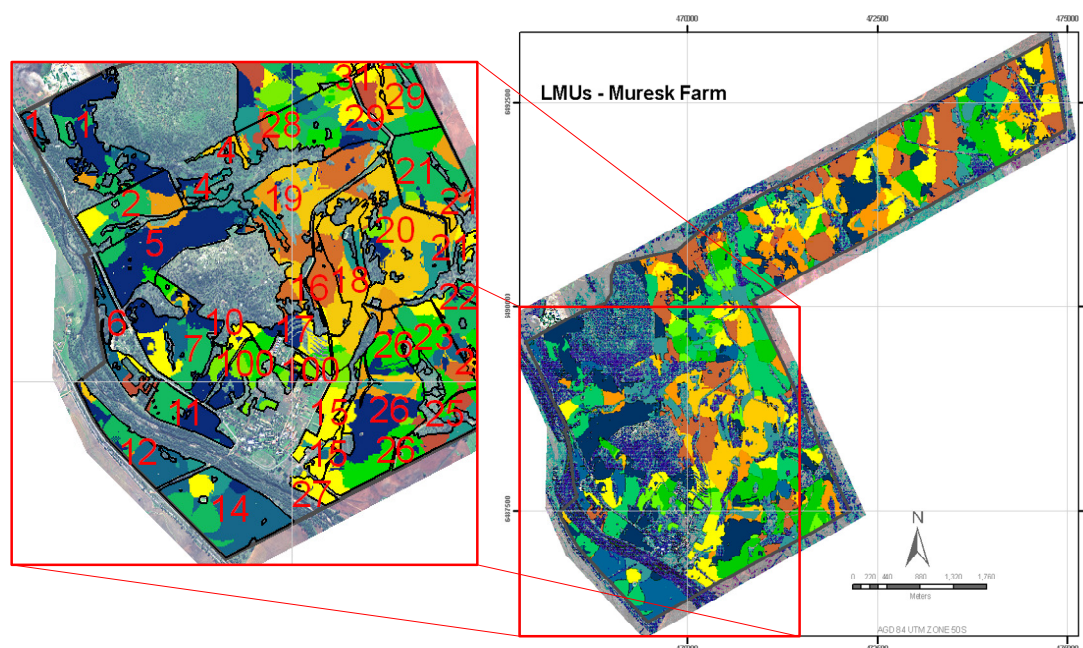

Figure 5.10 The original Muresk paddocks overlay on the LMU defined by Warren (2007)

### 5.3.2 Crop type

The crop types/varieties utilised in this thesis are based on the WA Wheat settings, as well as Muresk historical data. At Muresk, a number of different crop types, namely wheat, canola, lupins, barley, oats, clover and fodder, are sown on an annual basis.

The varieties of the crop types are as follows:

- Wheat: Calingari and Carnamah;
- Canola: 402 CL and Surpass 501;
- Barley: Stirling and Clippr;
- Lupins: Tanjil and Merritts.

Seed price and seeding rates were taken from Muresk Farm records (see Table 5.8).

Table 5.8 Summaries of different crop type and the average cost of seed and seeding rates

Crop Type	Variety Name Assigned	Price AU\$/kg	Seeding Rate kg/ha
<b>Wheat</b>	Calingari	0.25	80
	Carnamah	0.47	80
<b>Canola</b>	402 CL	0.16	50
	Surpass 501	0.16	50
<b>Barley</b>	Stirling	3.50	30
	Clippr	3.50	42
<b>Lupins</b>	Tanjil	0.60	100
	Merritts	0.13	80

WA Wheat produces both yield (t/ha) and quality (protein) information. The protein levels can be used to classify the wheat produced into quality classes (Table 5.9.)

Table 5.9 Crop quality parameters (refer to Table 2.4)

Production ID	Quality Classification	Crop Type	Minimum Protein	Maximum Protein
1	APH	Wheat	13%	100%
2	AH	Wheat	11.5%	12.99%
3	APW	Wheat	10%	100%
5	ASW	Wheat	0%	100%
6	ASWN	Wheat	9.5%	11.5%
12	Feed Wheat *	Wheat	0%	100%

\* As the threshold values are based on the protein level, feed weed will not be used due to the lack of definite constraint.

### 5.3.3 Fertiliser and chemical spray

The Muresk Farm has routinely used a wide range of fertiliser types based on soil nutrient levels and assessed plant needs. The WA Wheat model, however, only accounts for the nitrogen fertiliser applied and assumes that all other nutrients are applied at optimum levels. WA Wheat provides four types of nitrogen fertilising options: No fertilising, 30 kg/ha, 50 kg/ha and 100 kg/ha. The WA Wheat data enables fertiliser application at sowing time and four weeks later.

The impact of variable pesticide applications has not been incorporated into *MOLup* calculations because the WA Wheat model does not include weed and pesticide spraying in its land-use management options. However, the cost of spraying has been included as part of the operating expenses of the farm. In the future, it is recommended that models, which include spraying and its impact, will be able to be integrated into *MOLup*.

## 5.4 Market

As described in Section 4.3.5, two methods for selling crop products are used in this case study: spot cash market and forward contract. The spot cash market can be estimated by using two methods: data driven and a hybrid method between data and knowledge driven.

The data driven approach uses a set of historical data to estimate the possible spot cash price. However, as noted in Section 4.3.5.1, such datasets need to be

comprehensive enough to adequately represent the overall population; and recognise that spot price data that is too old is usually not acceptable since most of the factors that influenced the spot price at the time may no longer exist.

The hybrid data-knowledge driven method (Section 4.3.5.1.2) forecasts price based on a simulation where the current spot price acts as the mean, and the variability is derived from the user's subjective knowledge. Both of the proposed methods still require further study and validation. However, this is outside the scope of this thesis. Due to the unavailability of appropriate historical data, a synthetic data set is used instead. Accordingly, a set of historical spot price data from 1989 to 2005 was created based on weather condition during these years. These data were then used to estimate the spot cash price of 2006.

For the second approach for estimating the spot cash price, *MOLup* uses the current cash price of the crop. Generally, companies offer different prices at different points in time (see Table 5.10 for sample). For this case study, *MOLup* uses the cash and pool prices offered by the AWB and AgraCorp, which are provided by ProFarmer Weekly updates (see Table 5.10). From the table it can be seen that from January to September 2006, the prices did not fluctuate significantly. The steady movement of the cash and pool prices can also be seen in Figure 5.11.

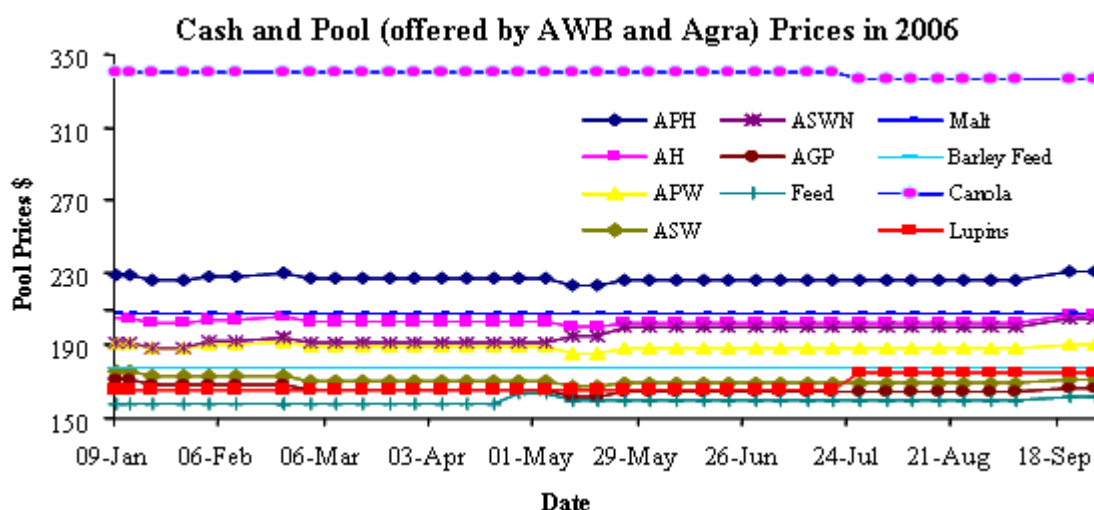

Figure 5.11 Cash and pool price charts prices of different crop products

The contract price was assumed to be the pool prices offered by the AWB and AgraCorp (Table 5.10).

Table 5.10 Cash and pool prices utilised for the case study

Date	APH \$	AH \$	APW \$	ASW \$	ASWN \$	AGP \$	Feed \$	Malt \$	Barley Feed \$	Canola \$	Lupins \$
09-Jan	228.5	205	191	176	191	171	158	207.5	176.5	340	165
13-Jan	228.5	205	191	176	191	171	158	207.5	176.5	340	165
19-Jan	225.5	202	188	173	188	168	158	207.5	176.5	340	165
27-Jan	225.5	202	188	173	188	168	158	207.5	176.5	340	165
03-Feb	227.5	204	190	173	192	168	158	207.5	176.5	340	165
10-Feb	227.5	204	190	173	192	168	158	207.5	176.5	340	165
23-Feb	229.5	206	192	173	194	168	158	207.5	176.5	340	165
23-Feb	229.5	206	192	173	194	168	158	207.5	176.5	340	165
02-Mar	226.5	203	189	170	191	165	158	207.5	176.5	340	165
09-Mar	226.5	203	189	170	191	165	158	207.5	176.5	340	165
16-Mar	226.5	203	189	170	191	165	158	207.5	176.5	340	165
23-Mar	226.5	203	189	170	191	165	158	207.5	176.5	340	165
30-Mar	226.5	203	189	170	191	165	158	207.5	176.5	340	165
06-Apr	226.5	203	189	170	191	165	158	207.5	176.5	340	165
13-Apr	226.5	203	189	170	191	165	158	207.5	176.5	340	165
20-Apr	226.5	203	189	170	191	165	158	207.5	176.5	340	165
27-Apr	226.5	203	189	170	191	165	163	207.5	176.5	340	165
04-May	226.5	203	189	170	191	165	163	207.5	176.5	340	165
11-May	223.5	200	186	167	195	162	160	207.5	176.5	340	165
18-May	223.5	200	186	167	195	162	160	207.5	176.5	340	165
25-May	225.5	202	188	169	200	164	160	207.5	176.5	340	165
01-Jun	225.5	202	188	169	200	164	160	207.5	176.5	340	165
08-Jun	225.5	202	188	169	200	164	160	207.5	176.5	340	165
15-Jun	225.5	202	188	169	200	164	160	207.5	176.5	340	165
22-Jun	225.5	202	188	169	200	164	160	207.5	176.5	340	165
29-Jun	225.5	202	188	169	200	164	160	207.5	176.5	340	165
06-Jul	225.5	202	188	169	200	164	160	207.5	176.5	340	165
13-Jul	225.5	202	188	169	200	164	160	207.5	176.5	340	165
20-Jul	225.5	202	188	169	200	164	160	207.5	176.5	340	165
27-Jul	225.5	202	188	169	200	164	160	207.5	176.5	337	175
03-Aug	225.5	202	188	169	200	164	160	207.5	176.5	337	175
10-Aug	225.5	202	188	169	200	164	160	207.5	176.5	337	175
17-Aug	225.5	202	188	169	200	164	160	207.5	176.5	337	175
24-Aug	225.5	202	188	169	200	164	160	207.5	176.5	337	175
31-Aug	225.5	202	188	169	200	164	160	207.5	176.5	337	175
07-Sep	225.5	202	188	169	200	164	160	207.5	176.5	337	175
21-Sep	230.5	207	190	171	205	166	162	207.5	176.5	337	175
28-Sep	230.5	207	190	171	205	166	162	207.5	176.5	337	175

It must be noted that the range of other crop parameters, such as delivery sites and methods, additional charges (e.g. CBH charges) and warehousing, are simplified by the assumption of pricing the crop at farm gate.

### 5.5 *MOLup* as the Tool

*MOLup* has been developed to help obtain optimum whole-farm management strategies which involve an interactive tactical decision-making process. Crucial highly variable drivers, like weather and market information, influence the course of management. The objectives for the 2006 growing season on the farm are to maximise profit and minimise the negative environmental impacts that may result from the production system selected.

While a model such as *MOLup* could be run daily; in this case study a smaller number of discrete points have been chosen (Table 5.11). These are:

- **At the beginning of the year (January)** most aspects of the whole-farm management system are unknown, with the exception of the history and performance of the paddock which become the constraints for crop type and input levels. During this time the farm manager develops a land-use plan and budget for the year;
- **At the end of March**, the criterion ‘summer rain’ has been determined and the sowing window is approaching. In this case, *MOLup* can be used to finalise the plan for the coming season. However, since no farming activities have been performed, the whole-farm management aspects are still open to consideration. Although in practice normally only an exceptional circumstance that would lead to a significant change in the plan;
- **At the end of April**, the sowing window has often opened and the break of the season is imminent. This break generally takes place from mid May until late June. During this period, decision-making usually involves time of sowing and input levels;
- **Later on in the sowing season (September)**, the sowing window has closed. At this stage, *MOLup* can be used to determine paddock performance (outputs) based on the weather conditions up to this point in time and the marketing options for non-contracted crop (see Section 5.5.4).

Table 5.11 Setting a scenario

January	February	March	April
Start of the year Heavy rain during the month		End of summer season The summer rain = 172.6mm	Unusual weather and very dry
May	June	July	August
End of early season Total rain = 33.9mm			
September	October	November	December
By the middle of the month, total annual rainfall = 360mm			

### 5.5.1 Results obtained for the January run

At the beginning of the year most aspects of the whole-farm management system for the year ahead, except the paddock history and performance, are largely unknown. At this point in time, the likelihood of occurrence of a specific seasonal type is a set of conditional probabilities evaluated by using historical weather information (see Table 5.4-January). Based on conditional probability, a set of crop production and environmental impact distributions are formed. The predicted distributions and expected crop price, also based on the weather conditions, are all used to simulate the most suitable whole-farm management options. In this case, the starting date is set at 1<sup>st</sup> January 2006, and the maximum number of paddock land-use management options is set to five. In addition, the paddock history and soil characteristics are also used to constrain the possible whole-farm option for each paddock (see Table 5.7 for details of paddock history).

Based on the input parameters, *MOLup* calculated 15,625 whole-farm options with only 27 optimal solutions (Figures 5.12 and 5.13). Figure 5.12 illustrates the set of whole-farm management options provided by *MOLup*, while Figure 5.13 illustrates only the most suitable set of whole-farm options selected by the *Pareto Optimisation* approach. The 15,625 whole-farm options are formed by permutating the five preselected land-use management options for each of the six paddocks considered. These preselected land-use management options are shown in Figure 5.13.

Based on the observation-marginal value theorem (see Section 4.5.1), option *WLuM<sub>14817</sub>* was chosen. However, note that although *WLuM<sub>14817</sub>* was selected as the optimal solution based on the current condition, other options may come up with

more diverse land-use options. Whilst a more diverse land-use will lower farm risk, it may not achieve the highest return or lowest environmental impact. In addition, the option determined is not an absolute choice, instead it is only an indication to aid the farmer in their decision-making.

The following discussion is based on whole-farm option *WLuM<sub>14817</sub>* which results in the following set of land-use management outcomes (Figure 5.12):

- *Gully* sown to 402 CL (canola) around the 25th April 2006, with 50 percent of the initial soil water content and fertilised with 100 kg/ha of nitrogen at sowing time; and 30 kg/ha four weeks after the sowing date. This management option is expected to produce around 60 tonnes of canola;
- *Fine View* sown to 402 CL (canola) around the 25th April 2006 when there is a 50 percent of initial soil water content with an application of 100 kg/ha of nitrogen at sowing and with an expected yield of 64 tonnes of canola;
- *Jangelling* sown with Surpass 501 (canola) on the 25th April 2006, and fertilised with 100 kg/ha of nitrogen at sowing and it is expected to produce around 148 tonnes of canola;
- *Muresk-1* sown with Surpass 501 (canola) around the 25th April 2006, with 100 kg/ha of nitrogen at sowing and producing around 125 tonnes of canola;
- *Airstrip* sown with 402 CL (canola) when the initial soil water is 50 percent, with 100 kg/ha of nitrogen at around the 10th May 2006, followed by 50 kg/ha of nitrogen four weeks later and producing 31 tonnes of canola;
- *Siding* sown with 402 CL (canola) on the 25th April 2006 with 100 kg/ha of nitrogen, and 50 kg/ha four weeks later and producing 38 tonnes of canola.

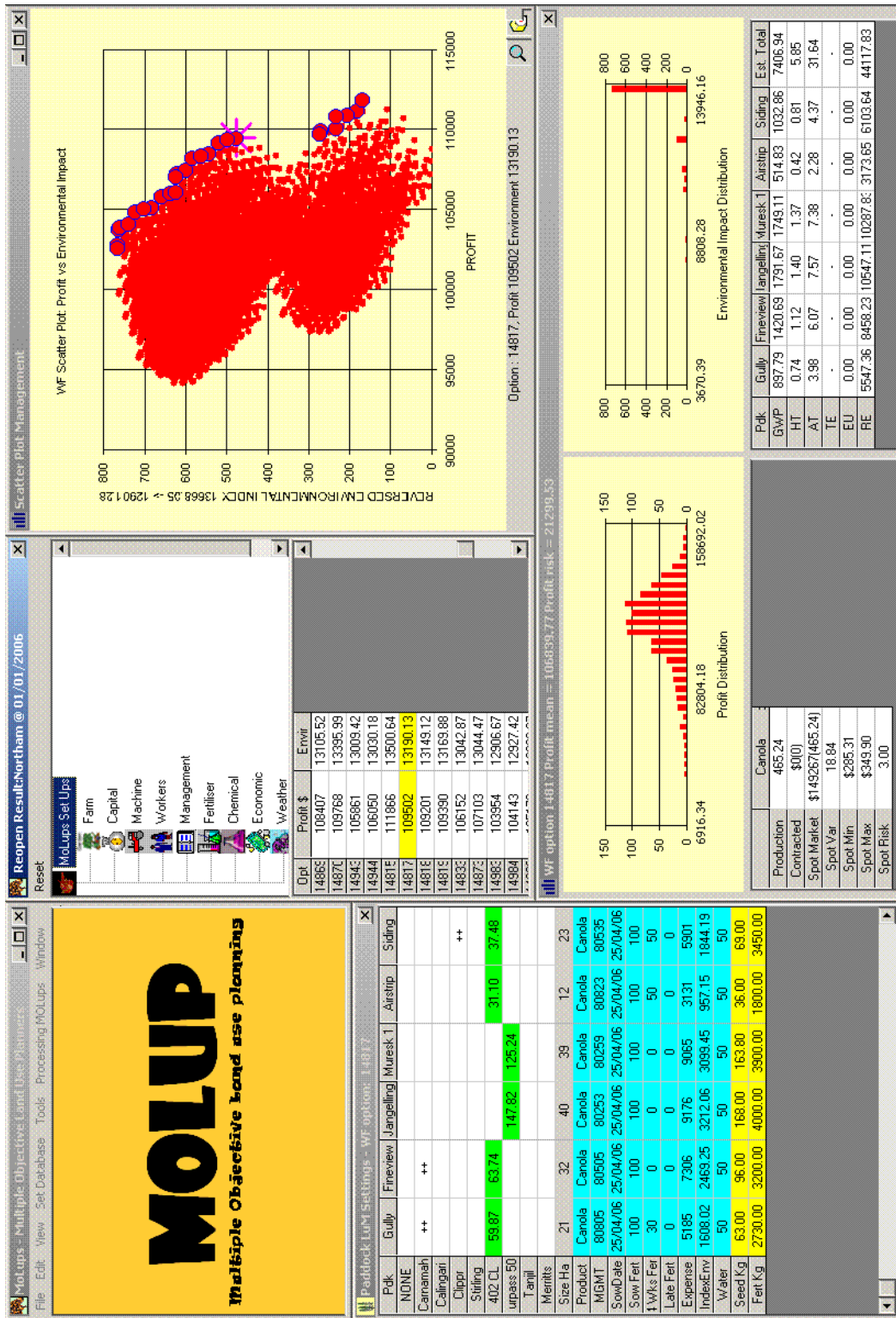

Figure 5.12 MOLup results for January with all estimated whole-farm management options (selected option  $WLuM_{14817}$ )



**Preselected Paddock Management Options**

The 5 preselected LuMs for paddock: Gully

Mgmt: 817 - Crop: Camamah Sow Date: 25 04 2006 Sow Fert: 100kgN 4W Fert: 50kgN @ Soil Water: 50%

Mgmt: 80589 - Crop: 402 CL Sow Date: 25 04 2006 Sow Fert: 0kgN 4W Fert: 30kgN @ Soil Water: 50%

Mgmt: 80649 - Crop: 402 CL Sow Date: 25 04 2006 Sow Fert: 30kgN 4W Fert: 0kgN @ Soil Water: 50%

Mgmt: 80733 - Crop: 402 CL Sow Date: 25 04 2006 Sow Fert: 50kgN 4W Fert: 30kgN @ Soil Water: 50%

Mgmt: 80805 - Crop: 402 CL Sow Date: 25 04 2006 Sow Fert: 100kgN 4W Fert: 30kgN @ Soil Water: 50%

Preview

Ok

(a) Gully

**Preselected Paddock Management Options**

The 5 preselected LuMs for paddock: Jangling

Mgmt: 80133 - Crop: Surpass 501 Sow Date: 25 04 2006 Sow Fert: 30kgN 4W Fert: 50kgN @ Soil Water: 50%

Mgmt: 80181 - Crop: Surpass 501 Sow Date: 25 04 2006 Sow Fert: 50kgN 4W Fert: 0kgN @ Soil Water: 50%

Mgmt: 80193 - Crop: Surpass 501 Sow Date: 25 04 2006 Sow Fert: 50kgN 4W Fert: 30kgN @ Soil Water: 50%

Mgmt: 80253 - Crop: Surpass 501 Sow Date: 25 04 2006 Sow Fert: 100kgN 4W Fert: 0kgN @ Soil Water: 50%

Mgmt: 80265 - Crop: Surpass 501 Sow Date: 25 04 2006 Sow Fert: 100kgN 4W Fert: 30kgN @ Soil Water: 50%

Preview

Ok

(c) Jangling

(b) Fine View

**Preselected Paddock Management Options**

The 5 preselected LuMs for paddock: Muresk-1

Mgmt: 80199 - Crop: Surpass 501 Sow Date: 25 04 2006 Sow Fert: 50kgN 4W Fert: 30kgN @ Soil Water: 50%

Mgmt: 80211 - Crop: Surpass 501 Sow Date: 25 04 2006 Sow Fert: 50kgN 4W Fert: 50kgN @ Soil Water: 50%

Mgmt: 80269 - Crop: Surpass 501 Sow Date: 25 04 2006 Sow Fert: 100kgN 4W Fert: 0kgN @ Soil Water: 50%

Mgmt: 80271 - Crop: Surpass 501 Sow Date: 25 04 2006 Sow Fert: 100kgN 4W Fert: 30kgN @ Soil Water: 50%

Mgmt: 80283 - Crop: Surpass 501 Sow Date: 25 04 2006 Sow Fert: 100kgN 4W Fert: 50kgN @ Soil Water: 50%

Preview

Ok

(d) Muresk-1

**Preselected Paddock Management Options**

The 5 preselected LuMs for paddock: Airstrip

Mgmt: 80727 - Crop: 402 CL Sow Date: 25 04 2006 Sow Fert: 50kgN 4W Fert: 0kgN @ Soil Water: 50%

Mgmt: 80739 - Crop: 402 CL Sow Date: 25 04 2006 Sow Fert: 50kgN 4W Fert: 30kgN @ Soil Water: 50%

Mgmt: 80751 - Crop: 402 CL Sow Date: 25 04 2006 Sow Fert: 50kgN 4W Fert: 50kgN @ Soil Water: 50%

Mgmt: 80823 - Crop: 402 CL Sow Date: 25 04 2006 Sow Fert: 100kgN 4W Fert: 50kgN @ Soil Water: 50%

Mgmt: 80824 - Crop: 402 CL Sow Date: 25 04 2006 Sow Fert: 100kgN 4W Fert: 50kgN @ Soil Water: 0%

Preview

Ok

(e) Airstrip

(f) Siding

Figure 5.13 *MOLup* result showing the paddock management choices for each paddock

It needs to be acknowledged that the sowing date is only indicative. The actual sowing can occur approximately one week before or after the given sowing date (Fisher, personal communication), thereby allowing the farmer to manage spraying and seeding equipment.

The expected profit for the selected option  $WLuM_{14817}$  shown in Figure 5.12 is \$109,502 and the aggregated environmental impact is estimated to be 13,190 units. The risk and the uncertainty of the result (profit and environmental impact) can be further observed in the objective histogram (Figure 5.14) and spread tables (Figure 5.15). The profit distribution indicates a fairly normal distribution with a slight skew to the left, ranging from \$6,916 up to \$158,692. The result also shows that the mean of this distribution is around \$106,840 with variability (i.e. one standard deviation) of \$21,300. The 95 percent confidence interval of the profit ranges from \$64,240 to \$149,440. Additionally, the environmental impact histogram shows that the simulation result is not normally distributed, with most of the impact stable around 14,000 units. This high variability would normally be of concern and lead to a reappraisal of the plan to spread the risk. In addition, the high variability is mainly due to the possible volatile weather condition and predicting market prices.

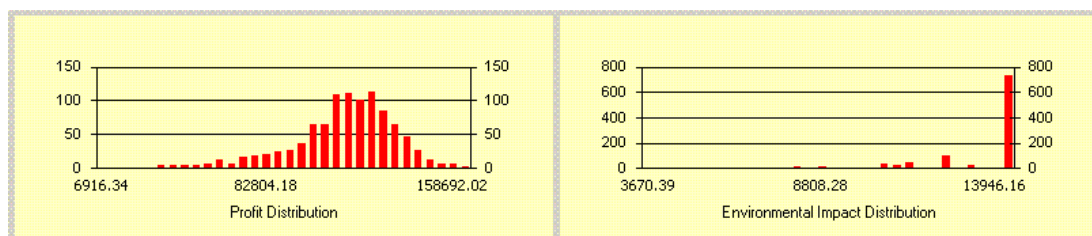

Figure 5.14 Histogram of the selected whole-farm options objective functions: profit versus environmental impact

	Canola		Pdk	Gully	Fineview	langelling	Muresk 1	Airstrip	Siding	Est. Total
Production	465.24		GWP	897.79	1420.69	1791.67	1749.11	514.83	1032.86	7406.94
Contracted	\$0(0)		HT	0.74	1.12	1.40	1.37	0.42	0.81	5.85
Spot Market	\$149267(465.24)		AT	3.98	6.07	7.57	7.38	2.28	4.37	31.64
Spot Var	18.84		TE	-	-	-	-	-	-	-
Spot Min	\$285.31		EU	0.00	0.00	0.00	0.00	0.00	0.00	0.00
Spot Max	\$349.90		RE	5547.36	8458.23	10547.11	10287.83	3173.65	6103.64	44117.83
Spot Risk	3.00									

Figure 5.15 The spread tables

The spread table on the left of Figure 5.15 shows the expected total *gross income* for the canola produced using the management options associated with  $WLuM_{14817}$ . The

total *gross income* for canola production has the potential to reach \$149,267 based on a total estimated production of canola of 465 tonnes and the estimated spot market of \$320.84 per tonne (i.e. a total of \$149,267 for 465.24 tonnes) with the estimated price variability of \$18.84 per tonne (Figure 5.15).

The spread table on the right (Figure 5.15) illustrates the environmental impact indices caused by the application of the suggested land-use management option on a paddock-by-paddock basis. The table shows that the land-use management applications on paddocks *Jangelling* and *Muresk-1* cause a higher total environmental impact than the applications on the other paddocks (see Table 5.12). However, the size of these paddocks is almost double the other paddocks and the impact per hectares is approximately equivalent.

Table 5.12 Sample of environmental impact GWP results for different paddocks

Paddock	Paddock Name	Size Ha	Total GWP for the Whole Paddock	GWP per ha	Fertiliser Application
Paddock 19	<i>Gully</i>	21	897.79	42.75	100/30
Paddock 21	<i>Fine View</i>	32	1420.69	44.40	100/0
Paddock 5	<i>Jangelling</i>	40	1791.67	44.79	100/0
Paddock 1	<i>Muresk-1</i>	39	1749.11	44.85	100/0
Paddock 16	<i>Airstrip</i>	12	514.83	42.90	100/50
Paddock 12	<i>Siding</i>	23	1032.86	44.91	100/50

Figure 5.16 shows the *Pareto Front* for the *MOLup* result as a staggered front with sudden changes in a number of places. A comparison between options  $WLuM_{14817}$  and  $WLuM_{14870}$ , shows that option  $WLuM_{14817}$  dominates option  $WLuM_{14870}$ , with respect to environmental impact although they both generate approximately the same production.

Additionally, both of the whole-farm options shown in Figure 5.17 are actually quite similar. One of the differences is the land-use management to be applied in *Siding*, where in option  $WLuM_{14817}$  402 CL canola is sown when there is enough initial soil water content, while in option  $WLuM_{14870}$  the *Siding* is sown with Clippr Barley when initial water availability is not optimal. Moreover, when *Airstrip* is sown with no initial soil water it seems to cause a lower environmental impact than when there is enough soil water. This suggests that nutrients are more effectively captured by the crop and not leached from the soil. In addition, application of fertiliser four weeks

after sowing as adopted in *Muresk-1* ( $WLuM_{14870}$ ) costs production, and decreases the amount of environmental impact. This again suggests more effective uptake of nutrients.

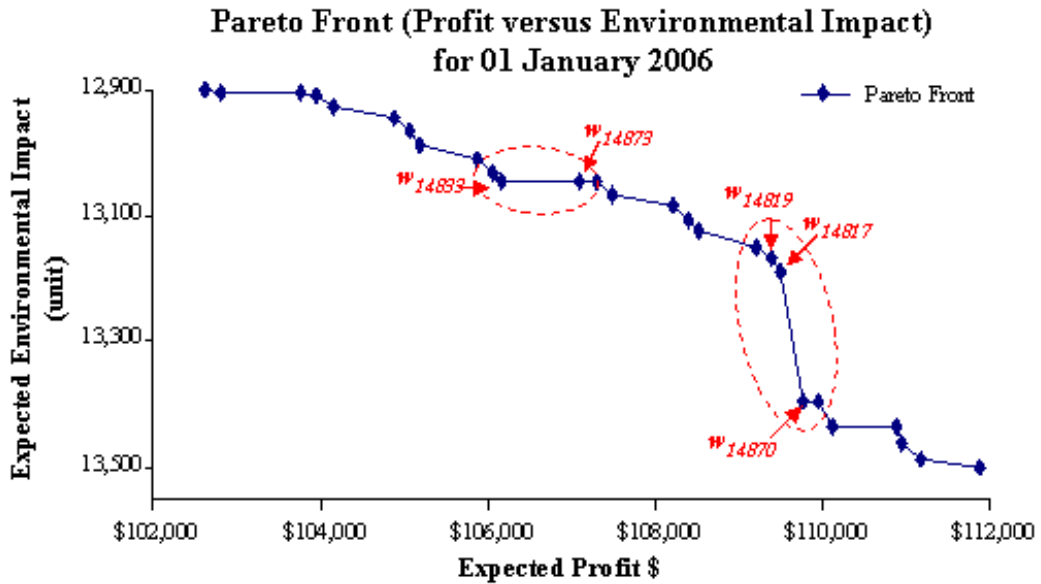

Figure 5.16 A close look at the *Pareto Optimal* for whole-farm management solutions provided for 01 January 2006

Paddock LuM Settings - WF option: 14870							
Pdk	Gully	Fineview	Jangelling	Muresk 1	Airstrip	Siding	
NONE							
Camamah	++	++					
Calingari							
Clippr							70.94
Stirling							
402 CL	59.87	63.74			27.74	++	
urpass 50			147.82	126.15			
Tanjil							
Merritts							
Size Ha	21	32	40	39	12	23	
Product	Canola	Canola	Canola	Canola	Canola	Canola	eed Barle
MGMT	80805	80505	80253	80283	80824	50536	
SowDate	25/04/06	25/04/06	25/04/06	25/04/06	25/04/06	25/04/06	
Sow Fert	100	100	100	100	100	100	
↓Wks Fert	30	0	0	50	50	50	
Late Fert	0	0	0	0	0	0	
Expense	5185	7306	9176	10338	3167	3446	
IndexEnv	1608.02	2469.25	3212.06	3035.10	916.85	2154.70	
Water	50	50	50	50	0	0	
Seed Kg	63.00	96.00	168.00	163.80	36.00	1150.00	
Fert Kg	2730.00	3200.00	4000.00	5850.00	1800.00	3450.00	

(a)  $WLuM_{14870}$

Paddock LuM Settings - WF option: 14817							
Pdk	Gully	Fineview	Jangelling	Muresk 1	Airstrip	Siding	
NONE							
Camamah	++	++					
Calingari							
Clippr							++
Stirling							
402 CL	59.87	63.74			31.10	37.48	
urpass 50			147.82	125.24			
Tanjil							
Merritts							
Size Ha	21	32	40	39	12	23	
Product	Canola	Canola	Canola	Canola	Canola	Canola	Canola
MGMT	80805	80505	80253	80259	80823	80535	
SowDate	25/04/06	25/04/06	25/04/06	25/04/06	25/04/06	25/04/06	
Sow Fert	100	100	100	100	100	100	
↓Wks Fert	30	0	0	0	50	50	
Late Fert	0	0	0	0	0	0	
Expense	5185	7306	9176	9065	3131	5901	
IndexEnv	1608.02	2469.25	3212.06	3099.45	957.15	1844.19	
Water	50	50	50	50	50	50	
Seed Kg	63.00	96.00	168.00	163.80	36.00	69.00	
Fert Kg	2730.00	3200.00	4000.00	3900.00	1800.00	3450.00	

(a)  $WLuM_{14817}$

Figure 5.17 Paddock *LuM* settings for whole-farm management options  $WLuM_{14870}$  and  $WLuM_{14817}$

Furthermore, a comparison between whole-farm options  $WLuM_{14833}$  and  $WLuM_{14873}$ , as indicated in Figure 5.16, shows that both options cause a similar amount of environmental impact, yet option  $WLuM_{14873}$  gives a higher profit. Figure 5.18

illustrates the paddock management plans for  $WLuM_{14833}$  and  $WLuM_{14873}$ . It shows that both options have a similar whole-farm plan; however, although options  $WLuM_{14833}$  would apply less fertiliser in *Muresk-1*, the total expenses are higher than for option  $WLuM_{14873}$ . This may be caused by additional treatments like spraying, which occur randomly due to its uncertain occurrence.

(a)  $WLuM_{14833}$

(b)  $WLuM_{14873}$

Figure 5.18 Paddock  $LuM$  settings for whole-farm management options  $WLuM_{14833}$  and  $WLuM_{14873}$

While  $MOLup$  provides an indicative plan, the weather patterns for the forthcoming season are yet to show their hand and the model is rerun at the end of March.

From this result, canola seems to be a dominating crop type in most  $WLuM$  options (shown in Figures 5.12 and 5.13). Generally, canola is a profitable crop when it is produced well. However, there are a number of different factors influencing the success of canola production: crop rotation, market price, yield production and its quality. This is mainly because  $MOLup$  has not put a physical crop rotation restriction as a constraint in determining the most satisfying  $WLuM$  options.

### 5.5.2 Results obtained for the processes performed in March - planning stage

At the end of March, the summer period has concluded and the sowing window is approaching. At this point in time, any farm manager will be preparing and planning for the break of season. In doing so, purchases of seeds, fertiliser, chemicals and many other inputs must now be made.

As the summer rain has concluded reaching 172.6mm, this information is then used as a constraint in predicting the future season type; hence, the conditional probability of each season type can be predetermined. Since it was known that the summer rain is above the threshold value of 45.59mm, *MOLup* filters out half of the season types from consideration (see Table 5.13). At present, the rest of the season types are all likely to occur. Nevertheless, based on the historical data it is known that one season is more likely to occur than others (Table 5.13). The calculated conditional probability is then used to predict the possible crop production and environmental impact distribution sets, which in turn are used to simulate the optimum set of whole-farm options at 31<sup>st</sup> March 2006.

Table 5.13 Conditional probability when the summer rain is known

Season Type	Total Rainfall (mm)			Total Years Occur	Conditional Probability
	Summer	Early Season	Annual		
1	<=45.59	<=84.77	<=444.61	22	0.00
2	<=45.59	<=84.77	>444.61	12	0.00
3	<=45.59	>84.77	<=444.61	12	0.00
4	<=45.59	>84.77	>444.61	11	0.00
5	>45.59	<=84.77	<=444.61	8	0.28
6	>45.59	<=84.77	>444.61	7	0.24
7	>45.59	>84.77	<=444.61	2	0.07
8	>45.59	>84.77	>444.61	12	0.41

From the constraints and data given, *MOLup* simulated 15,625 whole-farm options with 22 of them being considered optimal solutions (Figure 5.19). Figure 5.21 shows that the *Pareto Front* is quite flat but changes significantly at two points: *WLuM*<sub>7701</sub> and *WLuM*<sub>7700</sub>.

The detail of the land-use management options for each paddock is shown in Figure 5.20. canola again predominates as the land-use choice based on a forecasted high price for canola. However, this is based on an assumption that the initial soil water content during the sowing date is 50 percent (Figure 5.20).



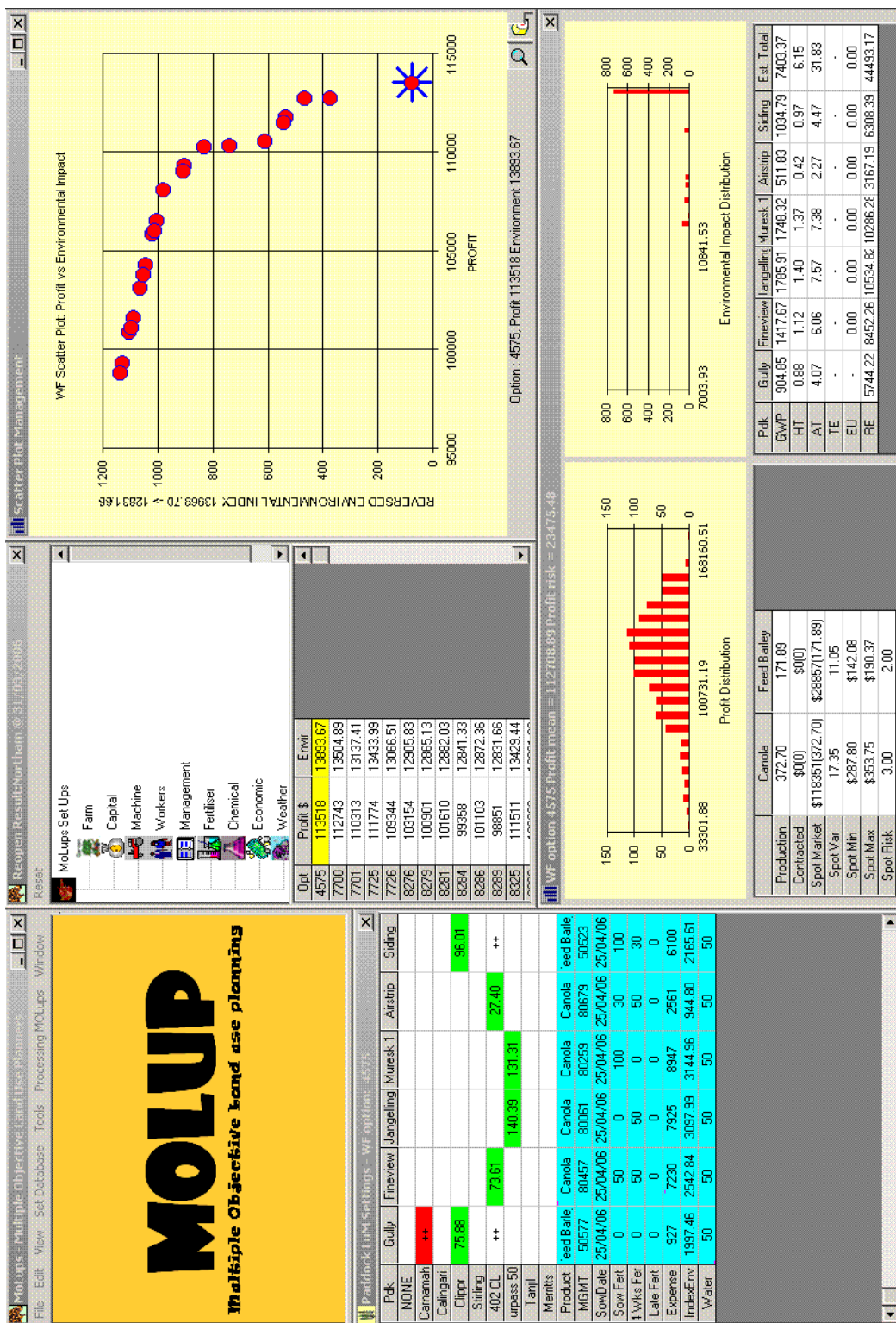
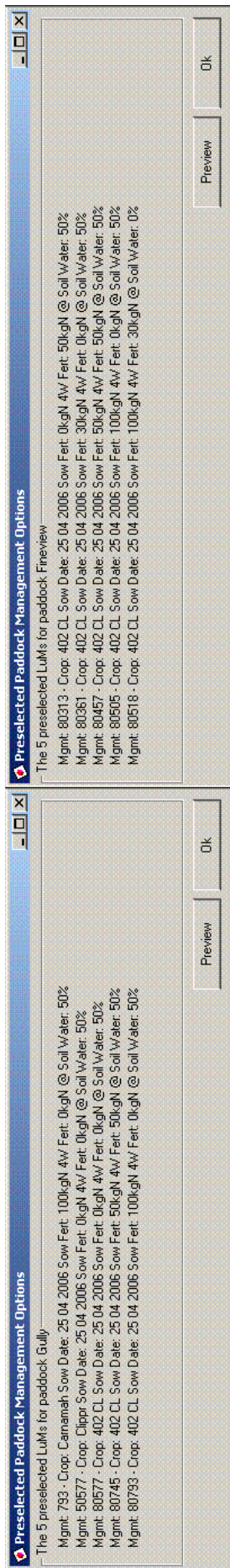
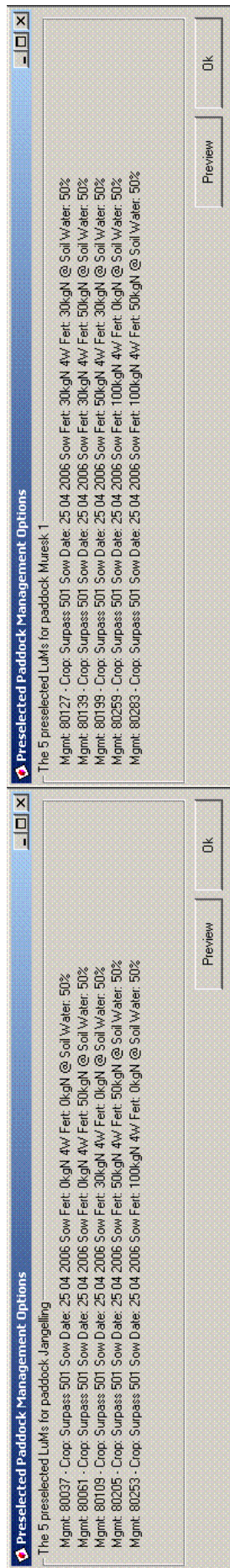

Figure 5.19 MOLup results for 31<sup>st</sup> March 2006 with whole-farm management option number WLU<sub>M</sub>4575



(a) Gully



(b) Fine View

(c) Jangling



(d) Muresk-1

(e) Airstrip

(f) Siding

Figure 5.20 Preselcted paddock land-use management for 31<sup>st</sup> March 2006



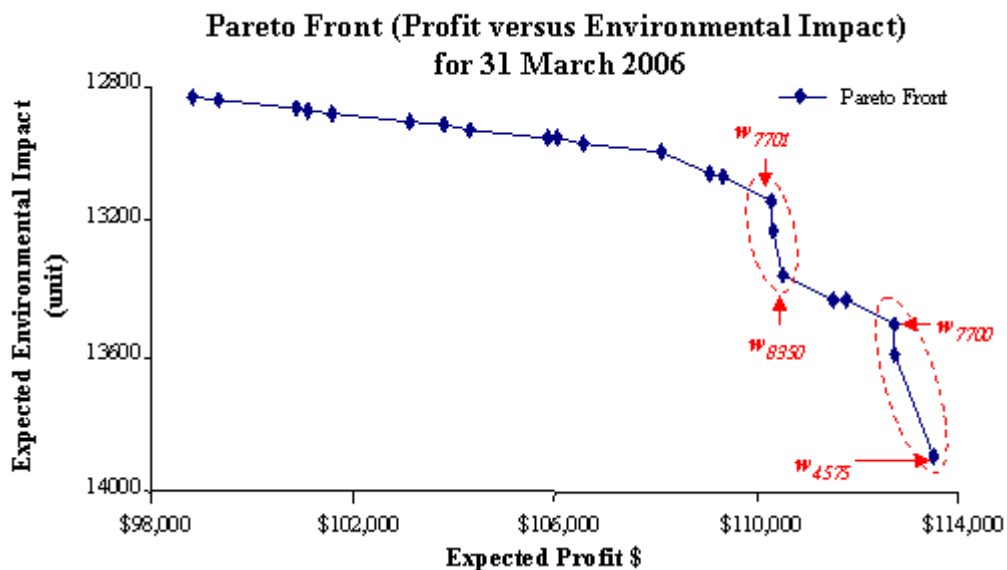

Figure 5.21 A close look at the *Pareto Optimal* for whole-farm management options for 31<sup>st</sup> March 2006

It needs to be noted that these pre-selected land-use management options were chosen as optimum solutions for each individual paddock by using a heuristic method based on unknown weather conditions. Since the initial soil water content is one of the aspects of paddock land-use management, it is assumed to be adaptable. However, from time to time, initial soil water content is a limiting factor in farming activities. For example, if the break of season occurs very late, canola tends to be dropped as an option. In this case, *MOLup* can be used to run a number of scenarios where water is the limiting factor.

At this point in time, although the break of season has not yet occurred, seeds and fertilisers must be purchased. The observation is made that when water is not a limiting factor, canola seems to be the optimum choice. However, weather is an unpredictable element, and it is therefore unsafe to assume good weather conditions and enough rain to support the production. The possibility of bad weather conditions must be considered.

It is easy to think of scenarios such as “what-if” the break of season is very late, without enough initial soil water content in the first one and half months of the sowing window to reach the 50 percent threshold. In this case, crop production may be estimated based on a specific weather condition scenario, where it is assumed that

the year is categorised within a season scenario where the year is started with a very wet summer but is followed by a very dry early season.

Table 5.14 The subjective assumption that the year has a wet summer but dry early season period

Season Type	Rainfall			Subjective
	Summer	Early Season	Annual	
1 (dry all year round)	<=45.59	<=84.77	<=444.61	Impossible
2	<=45.59	<=84.77	>444.61	Impossible
3	<=45.59	>84.77	<=444.61	Impossible
4 (dry summer, wet annually)	<=45.59	>84.77	>444.61	Impossible
5 (wet summer, dry annually)	>45.59	<=84.77	<=444.61	Likely to occur
6	>45.59	<=84.77	>444.61	Likely to occur
7	>45.59	>84.77	<=444.61	Impossible
8 (wet all year round)	>45.59	>84.77	>444.61	Impossible

In this case, the estimated crop production is based on the consideration that the early season period is going to be dry (see Table 5.14). In addition, as part of the assumption within the *MOLup* evaluation processes the initial soil water content during the early season is restricted to “None” (Figure 5.22).

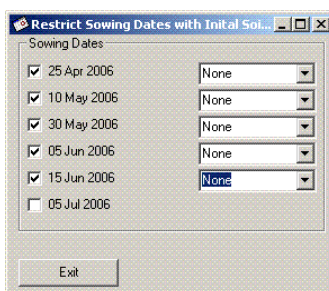

Figure 5.22 Restricting the initial soil water at different sowing date

Based on the constraint set on the initial soil water content at different sowing dates, *MOLup* offered 15,625 whole-farm options with only 10 optimal solutions (Figure 5.23). These results are based on the permutation of five paddock management options pre-selected for the six individual paddocks. This scenario has produced a change from canola to wheat in paddocks *Gully* and *Siding*.

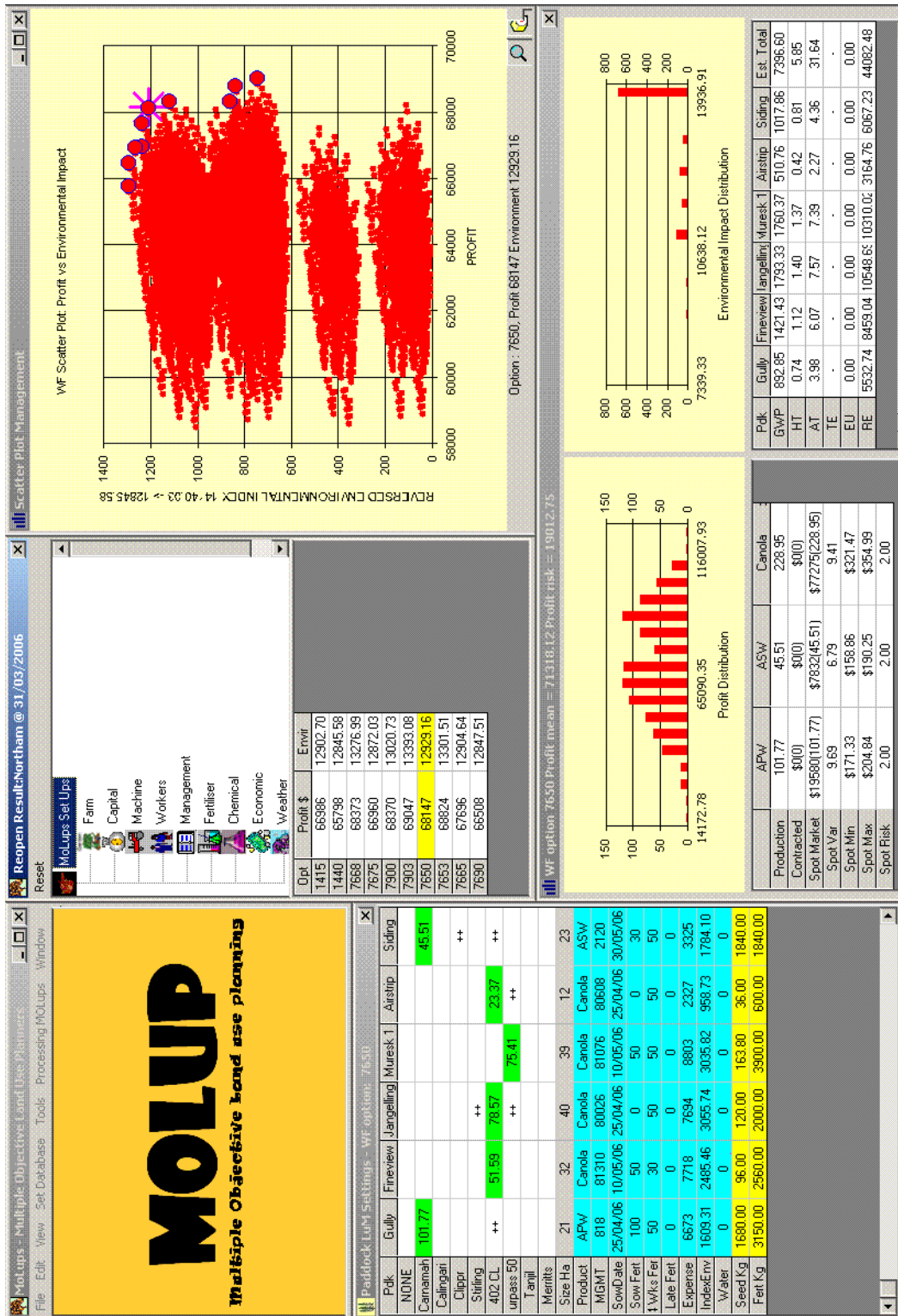
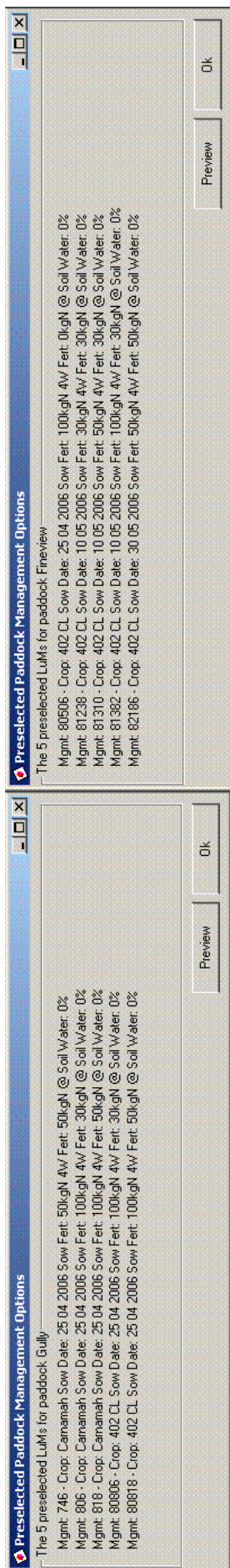

Figure 5.23 MOLUP results for 31<sup>st</sup> March 2006 after initial soil water constraint has been set (option number WLU<sub>M7650</sub>)



(a) Gully

(b) Fine View



(c) Jangelling

(d) Muresk-1



(e) Airstrip

(f) Siding

Figure 5.24 Preselected paddock management choices for each paddock as at 31<sup>st</sup> March 2006 after initial soil water constraint has been set



The changes in the pre-selected paddock land-use management solution cause a transformation of the *Pareto Front* solution, as well as the range of profit and environmental impact that the whole-farm may obtain (see Figure 5.25). Figure 5.25 shows when water is not a limiting factor, a number of whole-farm management options have the potential to obtain an expected profit of around \$114,000. However, when water is a limiting factor the maximum profit diminishes to around \$70,000, while the environmental impact caused does not change significantly.

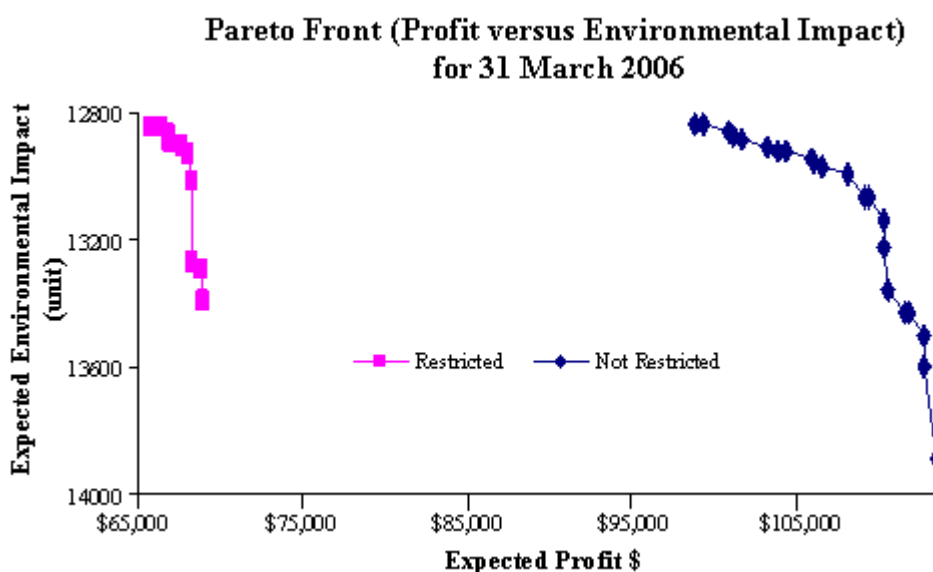

Figure 5.25 A close look at the *Pareto Optimal* for whole-farm management options at 31<sup>st</sup> March 2006, when water is the limiting factor (magenta) until 15<sup>th</sup> June 2006 and when water is not the limiting factor (blue)

In addition, the alterations cause a key change in the sowing date spread. When water is not a limiting factor, the sowing dates concentrate around the opening of the sowing window (25<sup>th</sup> April 2006), but if it is assumed that there will be a dry early season, the sowing date spreads from 25<sup>th</sup> April to 5<sup>th</sup> June.

### 5.5.3 Results obtained for the processes performed from April to July - during the sowing window

The analysis now moves to the beginning of the sowing window (end of April) and the seed required for the chosen management option has been purchased. Although the break of the season has not arrived, some of the paddocks need to be sown early. Since the seed has been purchased, individual paddocks are constrained to the type of

crop to be sown. Because the amount of fertiliser has not been set yet, *MOLup* can be used to determine the best fertiliser strategy.

The first paddocks to be sown are *Gully*, *Jangelling* and *Airstrip*, with wheat (Carnamah) on 30<sup>th</sup> April, canola (Surpass 501) on 7<sup>th</sup> of May and canola (402 CL) on 5<sup>th</sup> of May (respectively) as previously planned. Based on the settings, *MOLup* is then used to determine the amount of fertiliser needed at sowing time.

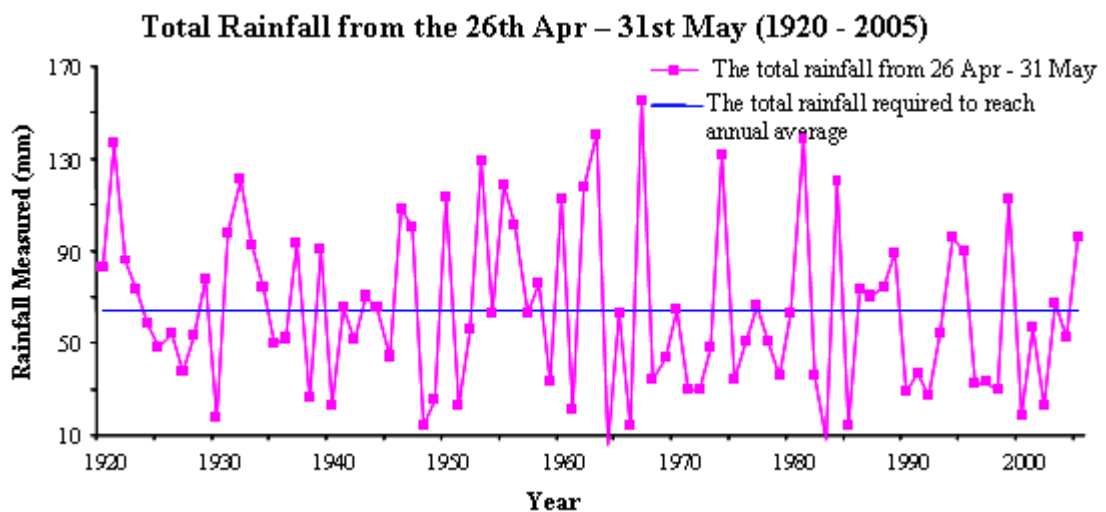

Figure 5.26 The total rainfall from 26<sup>th</sup> April - 31<sup>st</sup> May for the last 86 years (1920-2005)

In this case, the crop production distribution utilised is based on the weather conditions recorded up to the end of April, which shows limited rain. However, since the *criterion* early season rain has not yet concluded, experience and historical data are both required to subjectively assert the likelihood of the occurrence of a season type. As at 25<sup>th</sup> April, the total rain for the early season period has reached 20.9mm. Since the average early season rain is 84.77mm, the total rain from 26<sup>th</sup> of April 2006 until 31<sup>st</sup> May of 2006 needs to be 63.87mm. Based on the historical data, 39 out of 89 years fit the criteria where the total rain from 26<sup>th</sup> April until the end of May is higher than 63.87mm (Figure 5.26). Subsequently, the likelihood of the season type occurrence is set based on observations and historical data (see Table 5.15).

The subjective information provided by the farm manager is further used to predict the crop production and environmental impact distribution as at the end of April (i.e.

25<sup>th</sup> April 2006). These distributions will then be used to simulate the optimum solution based on the conditions prevailing on 25<sup>th</sup> April 2006.

Based on the constraints, *MOLup* produced 15,625 whole-farm options where 21 of them are potential optimal solutions (see Figure 5.27). Figures 5.30 and 5.31 illustrate the five pre-selected most promising alternatives for individual paddocks. As the sowing dates and crop type for *Gully*, *Jangelling* and *Airstrip* have been set, the pre-selected land-use management for these paddocks has been constrained based on the sowing dates and crop type.

Table 5.15 The subjective assumption of the likelihood occurrence of a season type as at the end of April

Season Type	Rainfall			Subjective
	Summer	Early Season	Annual	
1 (dry all year round)	<=45.59	<=84.77	<=444.61	Impossible
2	<=45.59	<=84.77	>444.61	Impossible
3	<=45.59	>84.77	<=444.61	Impossible
4 (dry summer, wet annually)	<=45.59	>84.77	>444.61	Impossible
5 (wet summer, dry annually)	>45.59	<=84.77	<=444.61	Likely to occur
6	>45.59	<=84.77	>444.61	Likely to occur
7	>45.59	>84.77	<=444.61	Neither nor likely to happen
8 (wet all year round)	>45.59	>84.77	>444.61	Neither nor likely to happen

Although the rainfall was limited up to the end of April, there is a possibility that it would improve during May. Nevertheless, the decision is made that, at sowing time, *Gully* is to be fertilised with 30 kg/ha, *Jangelling* with 50 kg/ha and *Airstrip* with 50 kg/ha of nitrogen (see Table 5.16). These conservative quantities limit financial loss in the advent of poor rainfall.

Table 5.16 Crop variety decision for different paddocks

Paddock	Paddock Name	Size Ha	Sown Crop Type	Sowing Date	Fertilising (Sowing)
Paddock 19	<i>Gully</i>	21	Wheat Carnamah	30 April 2006	30 kg/ha
Paddock 5	<i>Jangelling</i>	40	Canola Surpass 501	07 May 2006	50 kg/ha
Paddock 16	<i>Airstrip</i>	12	Canola 402 CL	05 May 2006	50 kg/ha

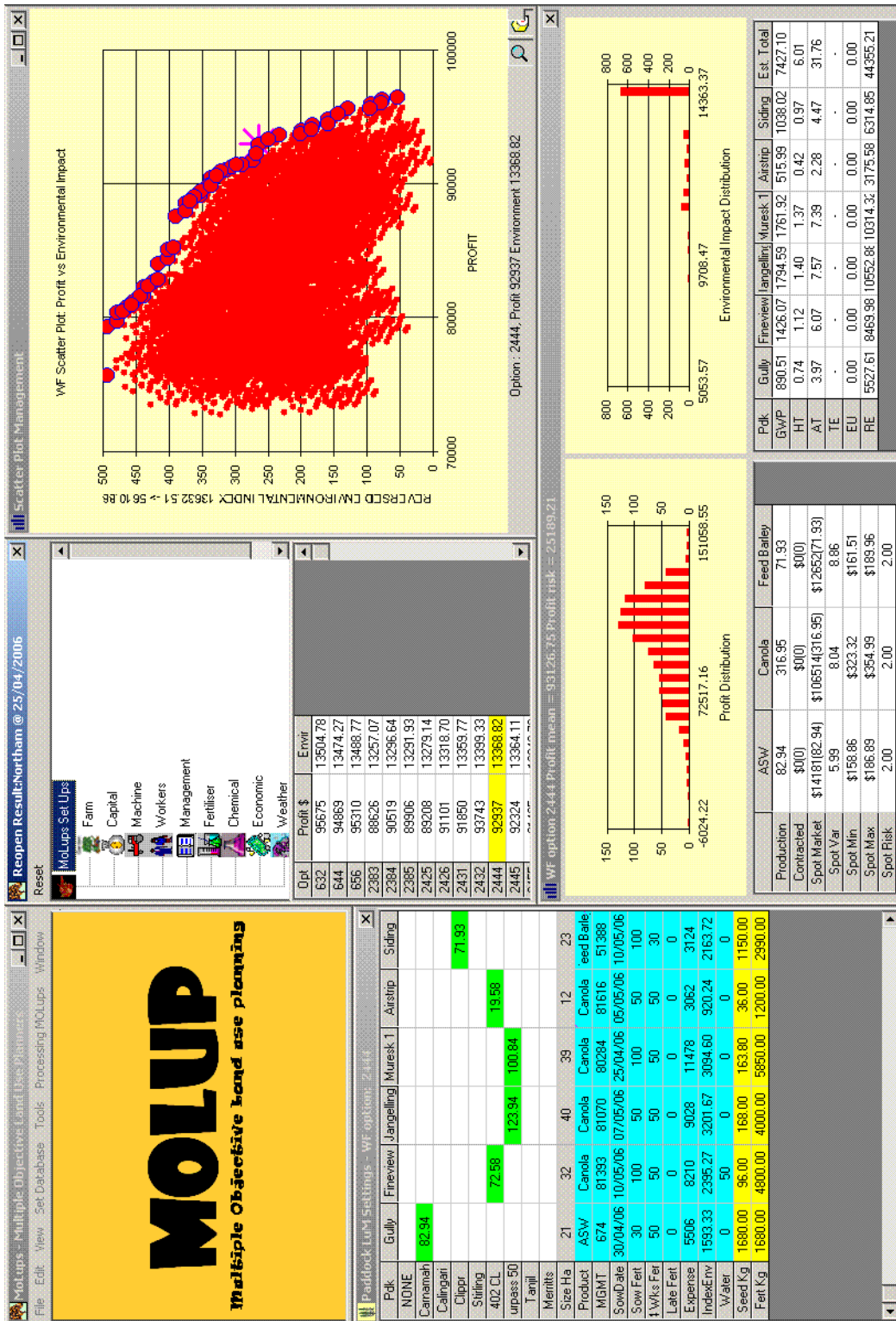

Figure 5.27 MOLUP results for April with whole-farm management option number WLM2444



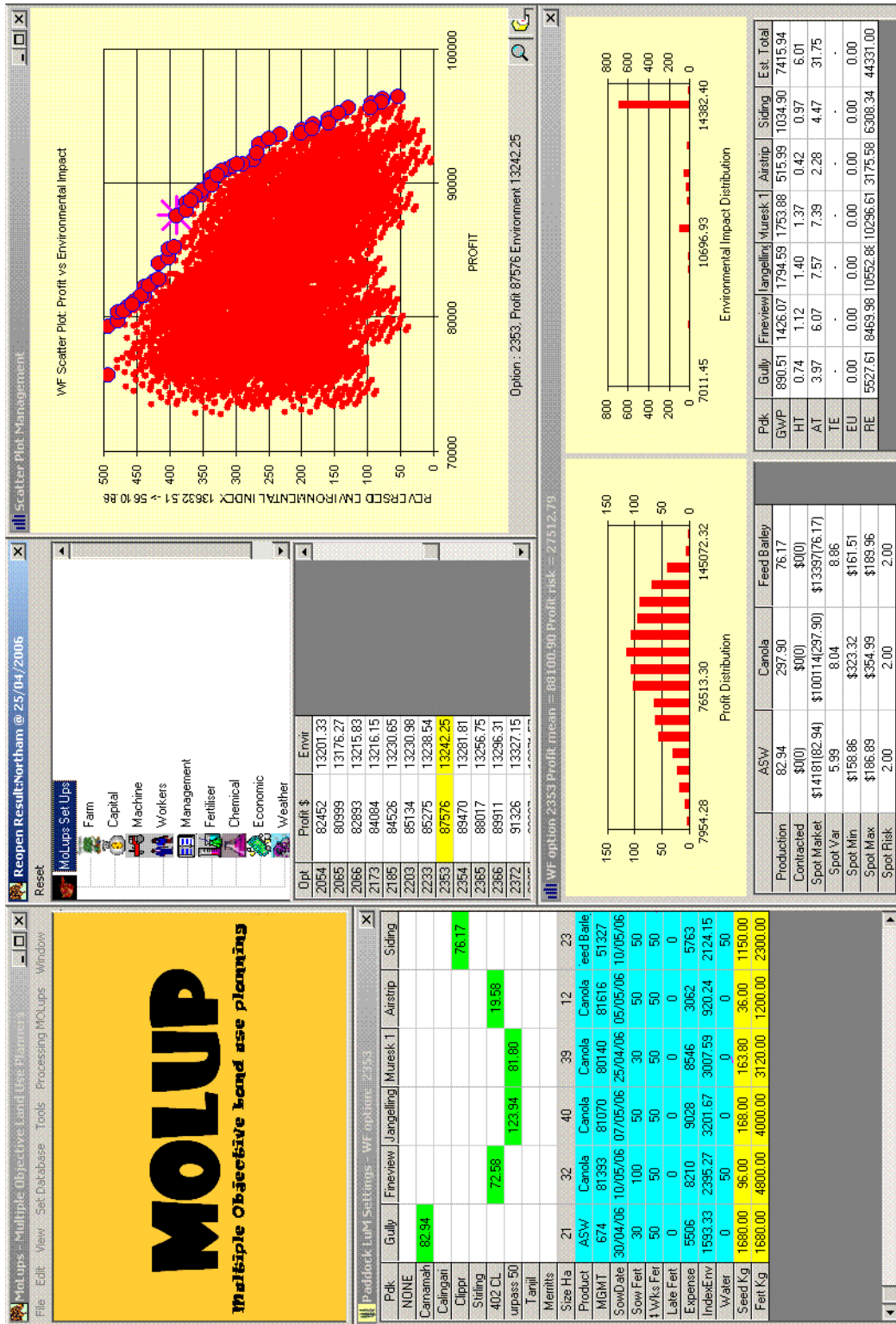
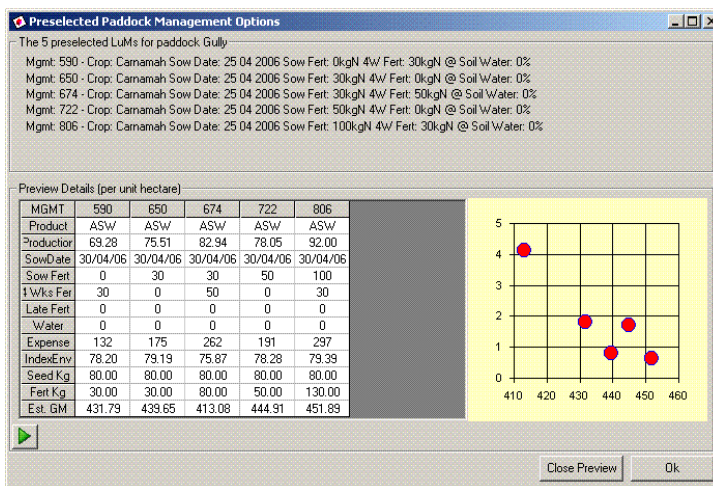
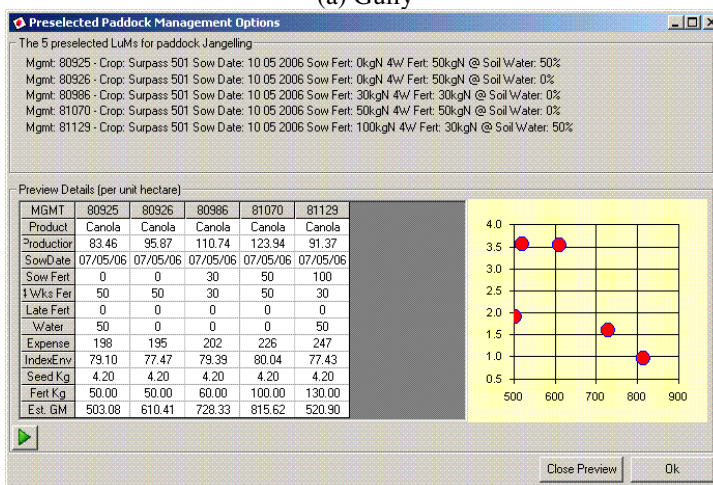

Figure 5.28 MOLUP results for April with whole-farm management option number WLM2353



(a) Gully



(b) Jangelling

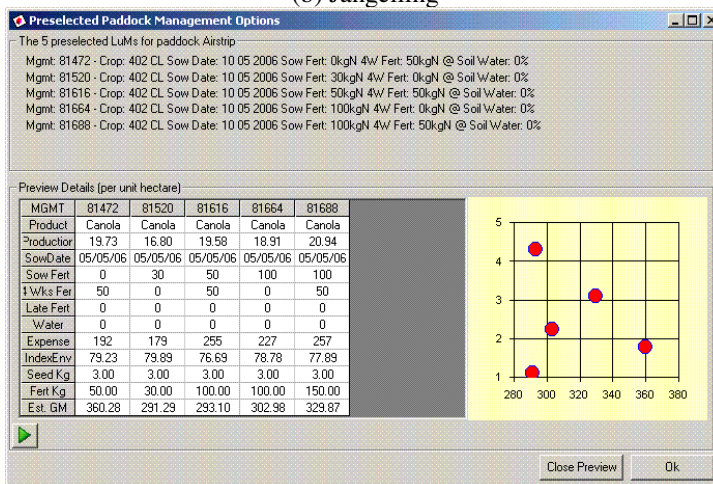

(c) Airstrip

Figure 5.29 Preselected LuMs for Gully, Jangelling and Airstrip on 25<sup>th</sup> April 2006

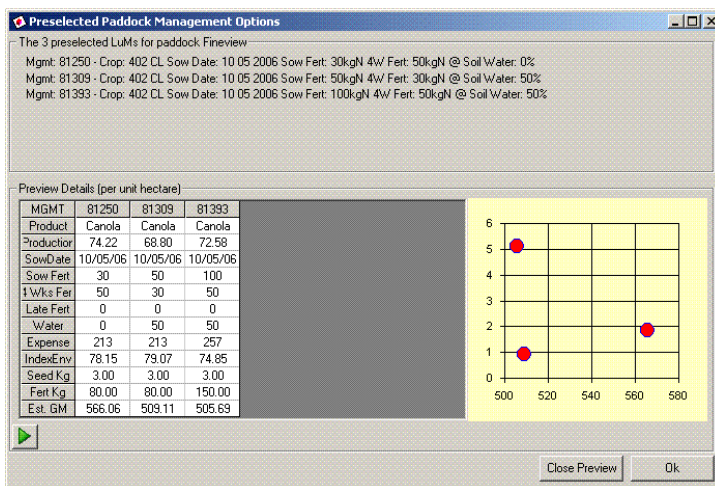

(a) Fine View

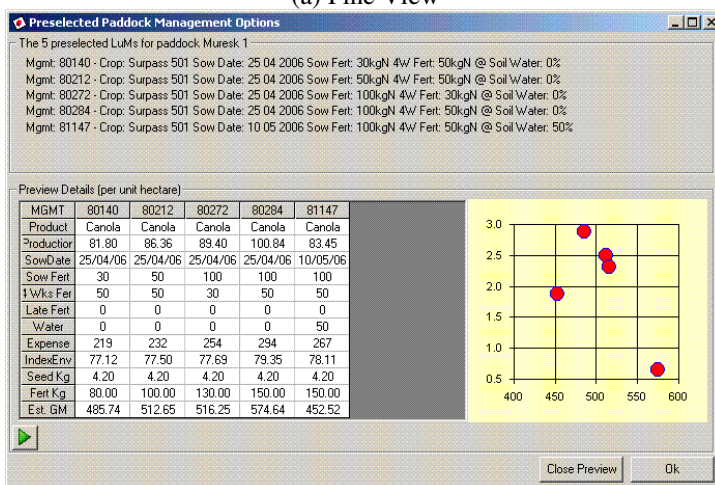

(b) Muresk-1

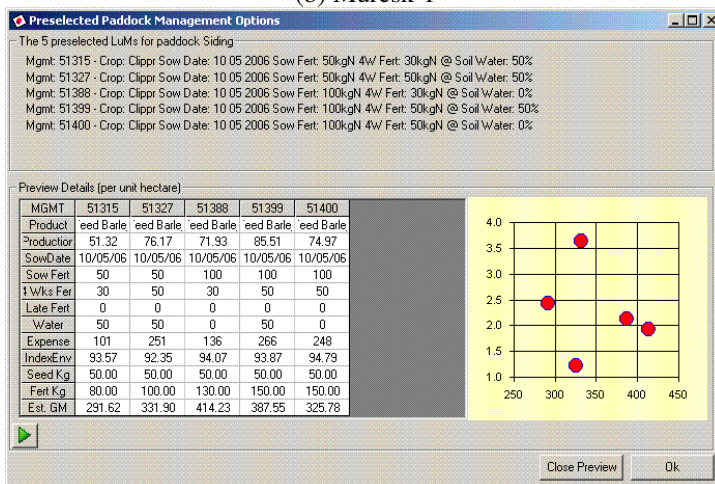

(a) Siding

Figure 5.30 Preselected LuMs for *Fine View*, *Muresk-1* and *Siding* on 25<sup>th</sup> April 2006

Four weeks later (at the end of May), the early season period has concluded and the break of the season has not arrived. Early season rainfall has only reached 33.6mm, which is significantly below the average early season rainfall of 84.77mm.



As the time has come to sow *Fine View*, *Muresk-1* and *Siding*, the amount of fertiliser to be applied onto these paddocks during the sowing time needs to be evaluated. The most suitable post sowing (four week) fertilising options for *Gully*, *Jangelling* and *Airstrip* also need to be determined. *MOLup* is run to evaluate the most suitable fertiliser options for individual paddocks. There is a limited amount of rain up to the end of May; however, the historical rainfall data shows that there is still some possibility that the average annual rainfall will be met in June. Additionally, since the necessary seed has been purchased at the beginning of the year, the decision is made to proceed with the sowing plan formed back in March.

Because the early season has concluded and the accumulated rain for the early season period has reached only 33.6mm; the criterion “early season rainfall” has filtered out the likelihood of season type seven and eight (see Table 5.17). As a result, the conditional probabilities of season type five and six are increasing. The newly formed likelihood value for different season types are then used to predict the potential crop production and environmental impact distribution. This distribution set is then input into *MOLup* to evaluate the most suitable fertiliser options for individual paddocks. In this case, the process is dated 28<sup>th</sup> May 2006 and the number limitation of preselected land-use management options is extended to ten.

Table 5.17 The conditional probability of the seasonal type based on the accumulated rain during summer and early season period of 2006

Season Type	Total Rainfall (mm)			Total Years Occur	Conditional Probability
	Summer	Early Season	Annual		
1	<=45.59	<=84.77	<=444.61	22	0.00
2	<=45.59	<=84.77	>444.61	12	0.00
3	<=45.59	>84.77	<=444.61	12	0.00
4	<=45.59	>84.77	>444.61	11	0.00
5	>45.59	<=84.77	<=444.61	8	0.53
6	>45.59	<=84.77	>444.61	7	0.47
7	>45.59	>84.77	<=444.61	2	0.00
8	>45.59	>84.77	>444.61	12	0.00

Based on these constraints, *MOLup* produced 486 whole-farm options with nine of them being potential optimal solutions (see Figure 5.32). Figures 5.31 and 5.33 illustrate all the pre-selected alternatives for each individual paddock. Figure 5.31 shows that the sowing date, crop type and first fertilising option for paddocks *Gully*,

*Jangelling* and *Airstrip* are static. This is due to the constraints imposed by the management actions already taken.

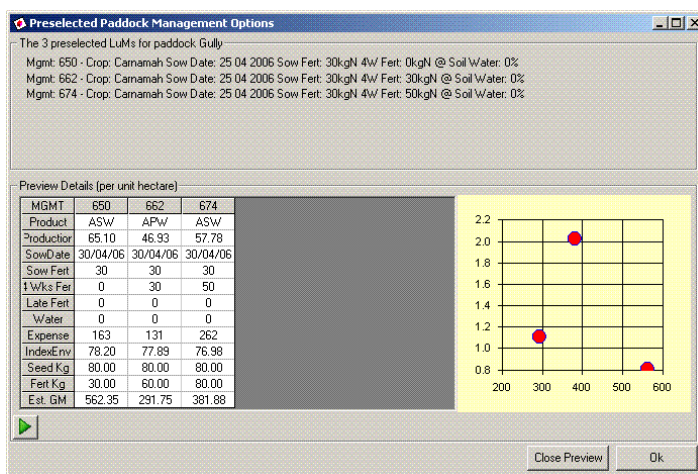

(a) Gully

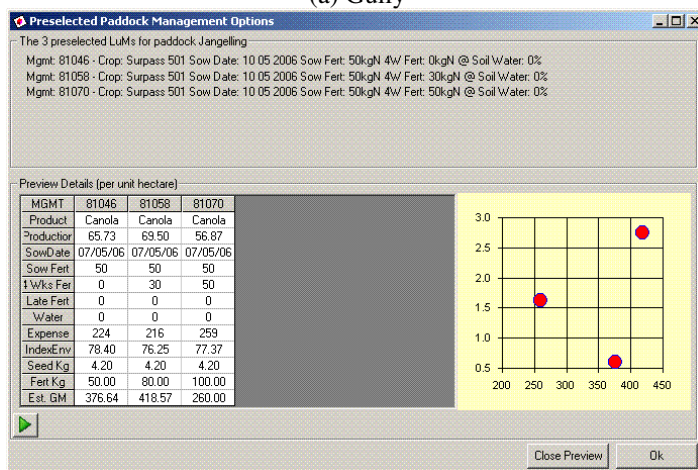

(b) Jangelling

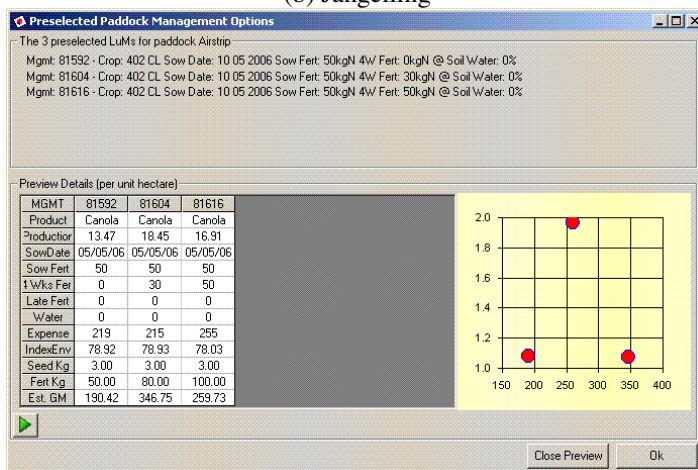

(a) Airstrip

Figure 5.31 Preselected *LuMs* for *Gully*, *Jangelling* and *Airstrip* paddocks at 28<sup>th</sup> May 2006

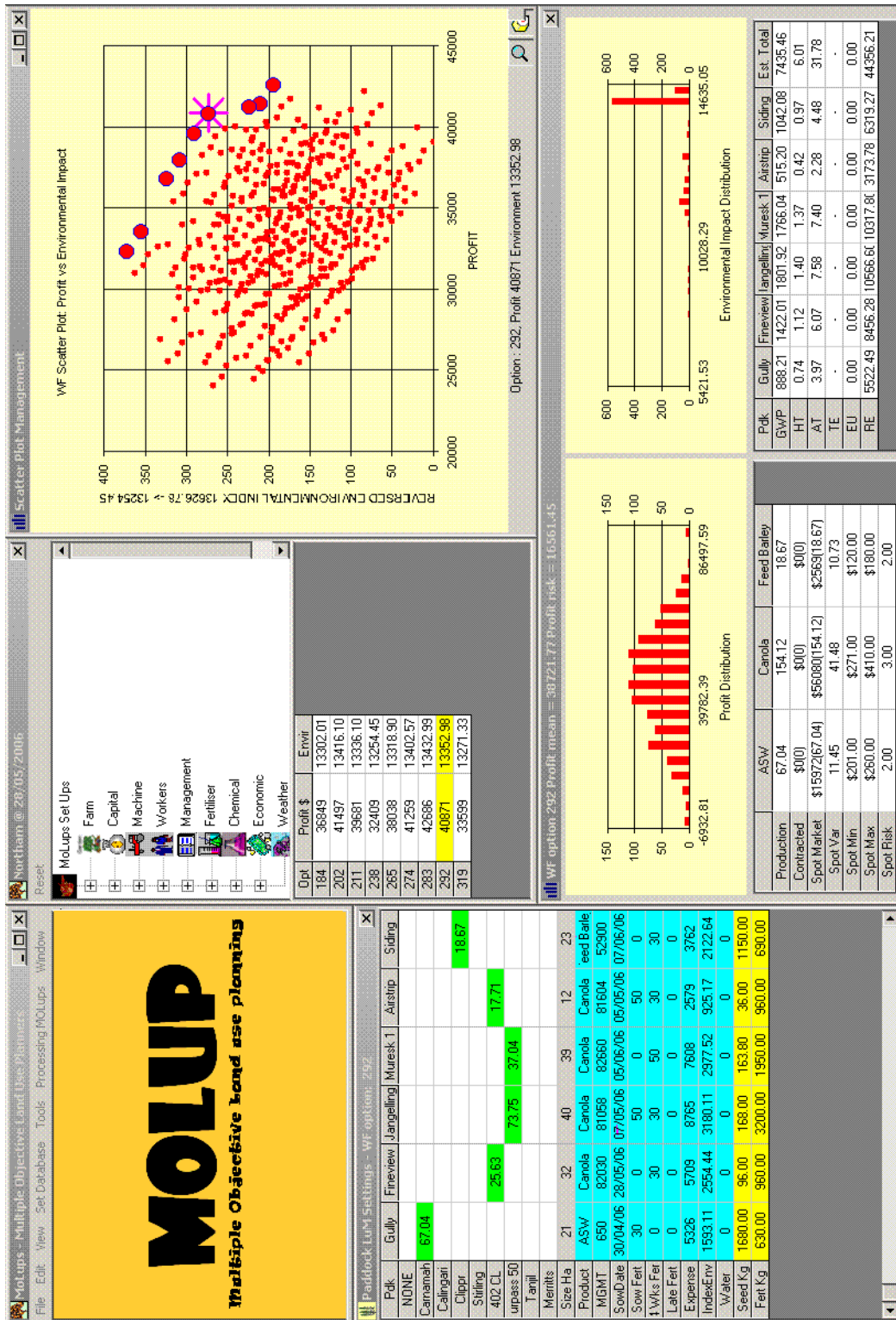
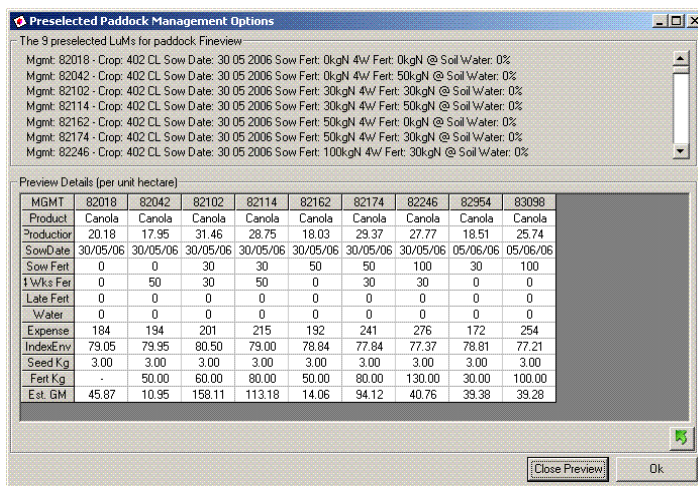
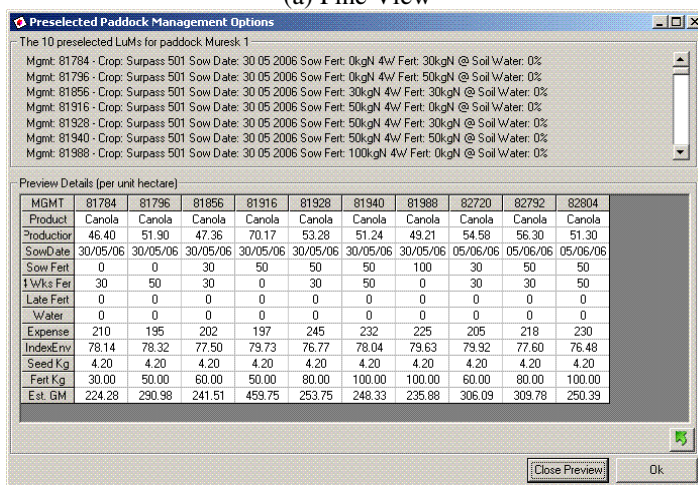

Figure 5.32 MOLup results for 28<sup>th</sup> May 2006 with whole-farm management option number WLM<sub>292</sub>



(a) Fine View



(b) Muresk-1

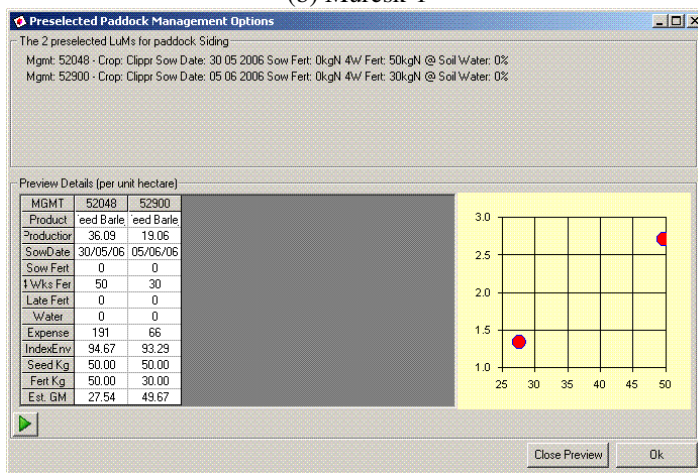

(c) Siding

Figure 5.33 Preselected LuMs for *Fine View*, *Muresk-1* and *Siding* paddocks at 28<sup>th</sup> May 2006

Based on the preselected option provided by *MOLup* (Figure 5.31), the following observations can be made regarding the fertilising options for paddocks *Gully*, *Jangelling* and *Siding*, in particular the post sowing (four weeks) applications:



- *Gully*: Options where no additional fertiliser is applied have a higher level of production and cause lower environmental impact compared to those options, which apply the fertiliser (Figure 5.31a);
- *Jangelling*: No additional fertiliser should be applied;
- *Airstrip*: The result shows that applying 30 kg/ha of nitrogen during the fourth week after sowing is the best solution and offers the highest potential production and causes similar levels of environmental impact as other options.

Furthermore, *MOLup* has provided information for decisions to be made on the paddocks *Fine View*, *Muresk-1* and *Siding* (Figure 5.33). These include:

- *Fine View* - From all nine pre-selected options (Figure 5.33a), four seem to be superior in terms of their production and lead to no marginal increase in environmental impact: *LuM<sub>82102</sub>*, *LuM<sub>82114</sub>*, *LuM<sub>82174</sub>* and *LuM<sub>82246</sub>*. However, based on the estimated gross margin, option *LuM<sub>82102</sub>* is superior to the others. Hence, option *LuM<sub>82102</sub>* was chosen which recommends an application of 30 kg/ha of nitrogen at sowing (Table 5.18);
- *Muresk-1* - Ten land-use management options have been pre-selected for this paddock. Option *LuM<sub>81916</sub>* appears superior to the others in terms of production and estimated gross margin, and has a marginal effect on environmental impact. This option involves applying 50 kg/ha of nitrogen at sowing (Table 5.18);
- *Siding* - Two alternatives have been pre-selected (Figure 5.33c), and both options indicate that no fertiliser is required at sowing. However, an application of 30 or 50 kg/ha of nitrogen should be applied four weeks after sowing.

Table 5.18 Decision on farming activities at the end of May 2006

Paddock	Paddock Name	Size Ha	Sown Crop Type	Sowing Date	Fertilising (Sowing)	Fertilising (4 Weeks)
Paddock 19	<i>Gully</i>	21	Wheat Carnamah	30 April	30 kg/ha	0 kg/ha
Paddock 5	<i>Jangelling</i>	40	Canola Surpass 501	07 May	50 kg/ha	0 kg/ha
Paddock 16	<i>Airstrip</i>	12	Canola 402 CL	05 May	50 kg/ha	30 kg/ha
Paddock 21	<i>Fine View</i>	32	Canola 402 CL	28 May	30 kg/ha	-
Paddock 1	<i>Muresk -1</i>	39	Canola Surpass 501	05 June	50 kg/ha	-
Paddock 12	<i>Siding</i>	23	Barley Clippr	07 June	0 kg/ha	-

At the end of June rainfall is still low. At this point, a decision on the annual rainfall probability is required by the farm manager. Based on the rainfall to date, a number



of season types have been categorised as “impossible” and only two possibilities, season types, five and six, are left. June turns out to be very dry with rainfall of 10.3mm (on 28<sup>th</sup> June). The most likely season type is narrowed down to type five (see Table 5.19). The model is run again based on this knowledge.

Table 5.19 Subjective assumptions of the likelihood of occurrence of seasonal types at the end of June (28<sup>th</sup> June 2006)

Season Type	Rainfall			Subjective
	Summer	Early Season	Annual	
1 (dry all year round)	<=45.59	<=84.77	<=444.61	Impossible
2	<=45.59	<=84.77	>444.61	Impossible
3	<=45.59	>84.77	<=444.61	Impossible
4 (dry summer, wet annually)	<=45.59	>84.77	>444.61	Impossible
5 (wet summer, dry annually)	>45.59	<=84.77	<=444.61	Likely to occur
6	>45.59	<=84.77	>444.61	Neither likely nor unlikely to happen
7	>45.59	>84.77	<=444.61	Impossible
8 (wet all year round)	>45.59	>84.77	>444.61	Impossible

Based on the predicted crop production, environmental impact distributions and the constraints imposed by the management actions already taken, *MOLup* is used to evaluate the second fertiliser option for *Fine View*, *Muresk-1* and *Siding*. Eight whole-farm management options are simulated and three of these are *Pareto Optimal* solutions.

As all essential farming activities for *Gully*, *Jangelling* and *Airstrip* have been performed (see Table 5.18 for details), each of these paddocks has been constrained to the implemented land-use option. There are a number of different preselected land-use management options for *Fine View*, *Muresk-1* and *Siding* (Figure 5.34). The preselected paddock land-use management options are:

- *Fine View*: For this paddock two management options have been offered. From the graph in Figure 5.34a it can be seen that  $LuM_{82102}$ , is superior to  $LuM_{82114}$ . This is based on gross margin and environmental impact. Accordingly, the conclusion is drawn that option  $LuM_{82102}$  is the most appropriate for *Fine View*, and 30 kg/ha of nitrogen should be applied four weeks after sowing (Table 5.20);
- *Muresk-1*: Two options have been suggested for this paddock:  $LuM_{82792}$  and  $LuM_{82904}$ . Figure 5.34b shows that none of the options are superior to the other. Option  $LuM_{82792}$  seems to be able to offer a higher gross margin while  $LuM_{82904}$

causes less environmental impact. Option *LuM<sub>82792</sub>* is chosen based on the prospect that weather is unlikely to improve and additional fertiliser would be unwise. Subsequently, 30 kg/ha of nitrogen will be applied to *Muresk-1* four weeks after sowing (see Table 5.20);

- *Siding*: For this paddock, two options have been pre-selected, *LuM<sub>52900</sub>* and *LuM<sub>52912</sub>*. Based on the gross margin results, it can be seen that both options are not able to cover the overhead cost of the application. Furthermore, the graph in Figure 5.34c shows that neither of the options is superior. In this case it is unwise to apply unnecessary fertiliser. Therefore, only 30 kg/ha of nitrogen should be applied to the paddock four weeks after sowing (see Table 5.20). Another possibility is to consider applying no fertiliser thereby saving costs.

Table 5.20 Farming activities decision at the end of June 2006

Paddock	Paddock Name	Size Ha	Sown Crop Type	Sowing Date	Fertilising (Sowing)	Fertilising (4 Weeks)
Paddock 19	<i>Gully</i>	21	Wheat Carnamah	30 April	30 kg/ha	0 kg/ha
Paddock 5	<i>Jangelling</i>	40	Canola Surpass 501	07 May	50 kg/ha	0 kg/ha
Paddock 16	<i>Airstrip</i>	12	Canola 402 CL	05 May	50 kg/ha	30 kg/ha
Paddock 21	<i>Fine View</i>	32	Canola 402 CL	28 May	30 kg/ha	30 kg/ha
Paddock 1	<i>Muresk -1</i>	39	Canola Surpass 501	05 June	50 kg/ha	30 kg/ha
Paddock 12	<i>Siding</i>	23	Barley Clippr	07 June	0 kg/ha	30 kg/ha

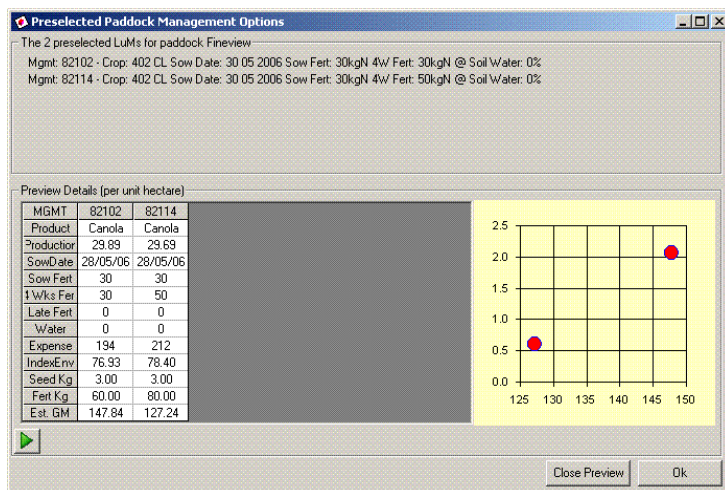

(a) Fine View

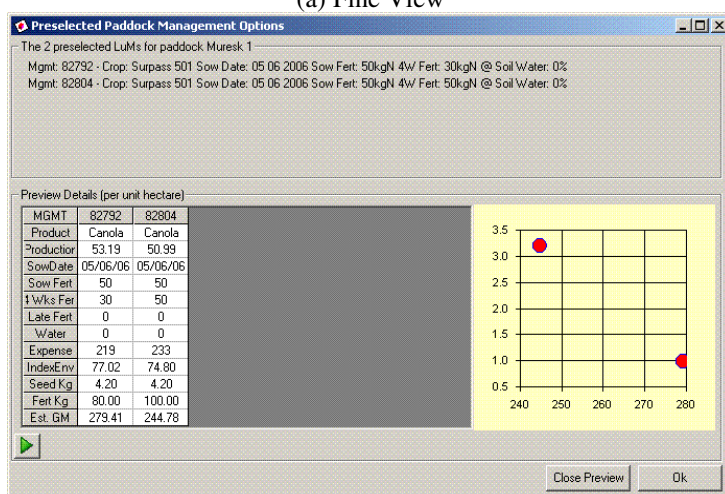

(b) Muresk-1

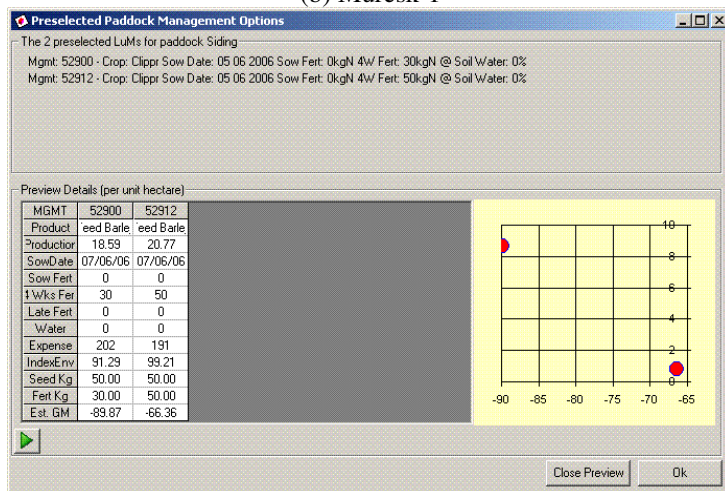

(c) Siding

Figure 5.34 Preselected LuMs for Fine View, Muresk-1 and Siding on 28<sup>th</sup> June 2006

#### 5.5.4 Post sowing window (July to September)

At this point all farming operations are complete but there is still the need to calculate final potential crop production and the environmental impact distribution.

Total annual rain to the middle of September (i.e. 14<sup>th</sup> September) has only reached 360mm, which is 84.61mm below average. On average, the total rain from the middle of September up to the end of the year is 64.63mm. In addition, over the last 86 years only on 20 occasions the total rainfall from 15<sup>th</sup> September - 31<sup>st</sup> December surpassed 84.61mm (Figure 5.35). This indicates a small chance that the total rain from the 15<sup>th</sup> September until the end of the year will reach 84.61mm. Consequently, season type five becomes the most probable occurrence (Table 5.21).

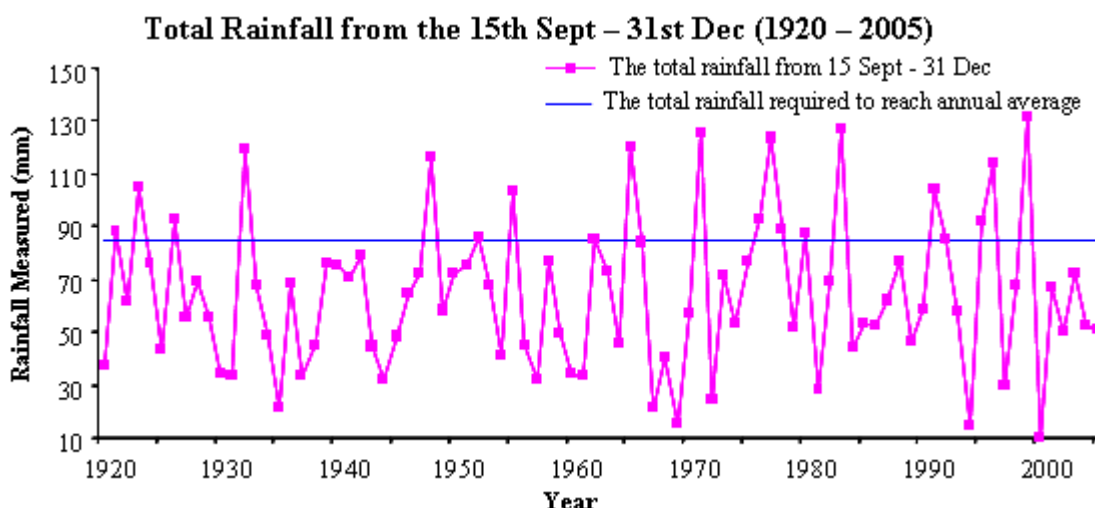

Figure 5.35 The total rainfall from the 15<sup>th</sup> September - 31<sup>st</sup> December for the last 86 years (1920-2005)

Table 5.21 The subjective assumptions of the likelihood of occurrence of the seasonal type at 14<sup>th</sup> September 2006

Season Type	Rainfall			Subjective
	Summer	Early Season	Annual	
1 (dry all year round)	<=45.59	<=84.77	<=444.61	Impossible
2	<=45.59	<=84.77	>444.61	Impossible
3	<=45.59	>84.77	<=444.61	Impossible
4 (dry summer, wet annually)	<=45.59	>84.77	>444.61	Impossible
5 (wet summer, dry annually)	>45.59	<=84.77	<=444.61	Very likely to occur
6	>45.59	<=84.77	>444.61	Very unlikely to happen
7	>45.59	>84.77	<=444.61	Impossible
8 (wet all year round)	>45.59	>84.77	>444.61	Impossible

The model is run using season type five to predict crop production, environmental impact, as well as the simulated spot cash price (see Figure 5.36). The result, shown in Figure 5.37, suggests a potential profit of approximately \$38,282 causing around 13,483 units of environmental impact.

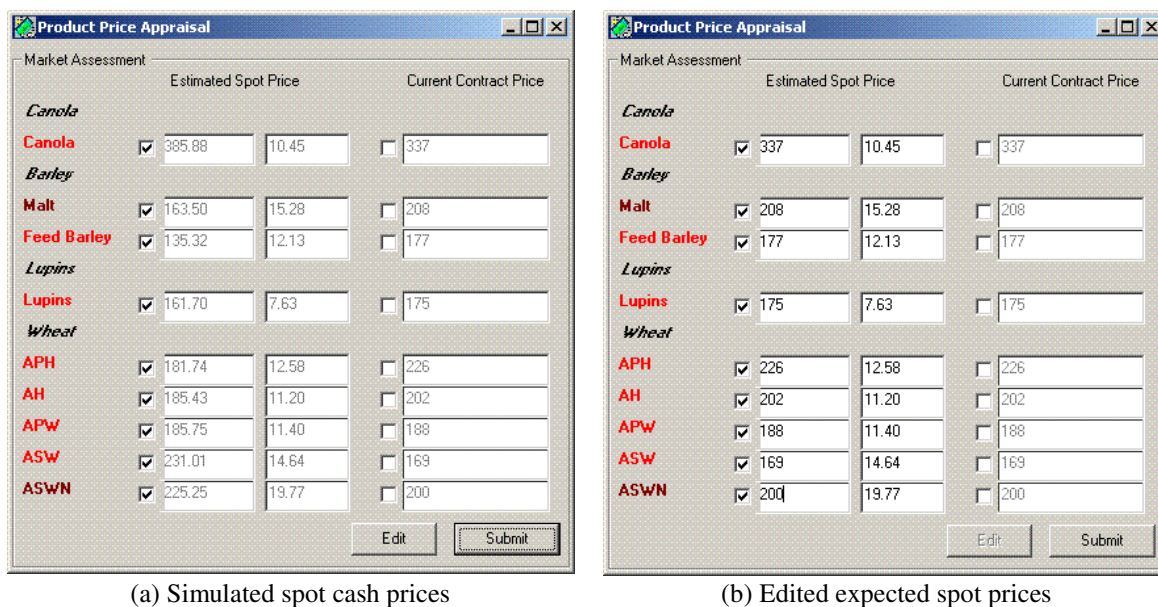

Figure 5.36 Spot price of different crop products

A comparison of the simulated spot price with the actual prices offered (see Table 5.10), as well as the movement of the cash market (Figure 5.11), indicates that the spot price simulated by *MOLup* is unrealistic. The estimated spot price must be edited based on actual experience, which is used to simulate a new set of crop price distributions. See Figure 5.36(a) and (b) for a comparison of spot price values.

The result is only one whole-farm management option, shown Figure 5.37 and 5.38 for simulated and edited spot cash prices, respectively. Based on both results (Figure 5.37 and 5.38), which are derived from two different estimated spot cash prices, it can be seen that there is a reduction of \$10,452 ( $\approx 30\%$ ) in profit, whereas there is only slight change in the environmental impact. Using edited spot cash prices, the potential profit from selected paddocks is approximately \$27,830, causing approximately 13,468 units of aggregated environmental impact.



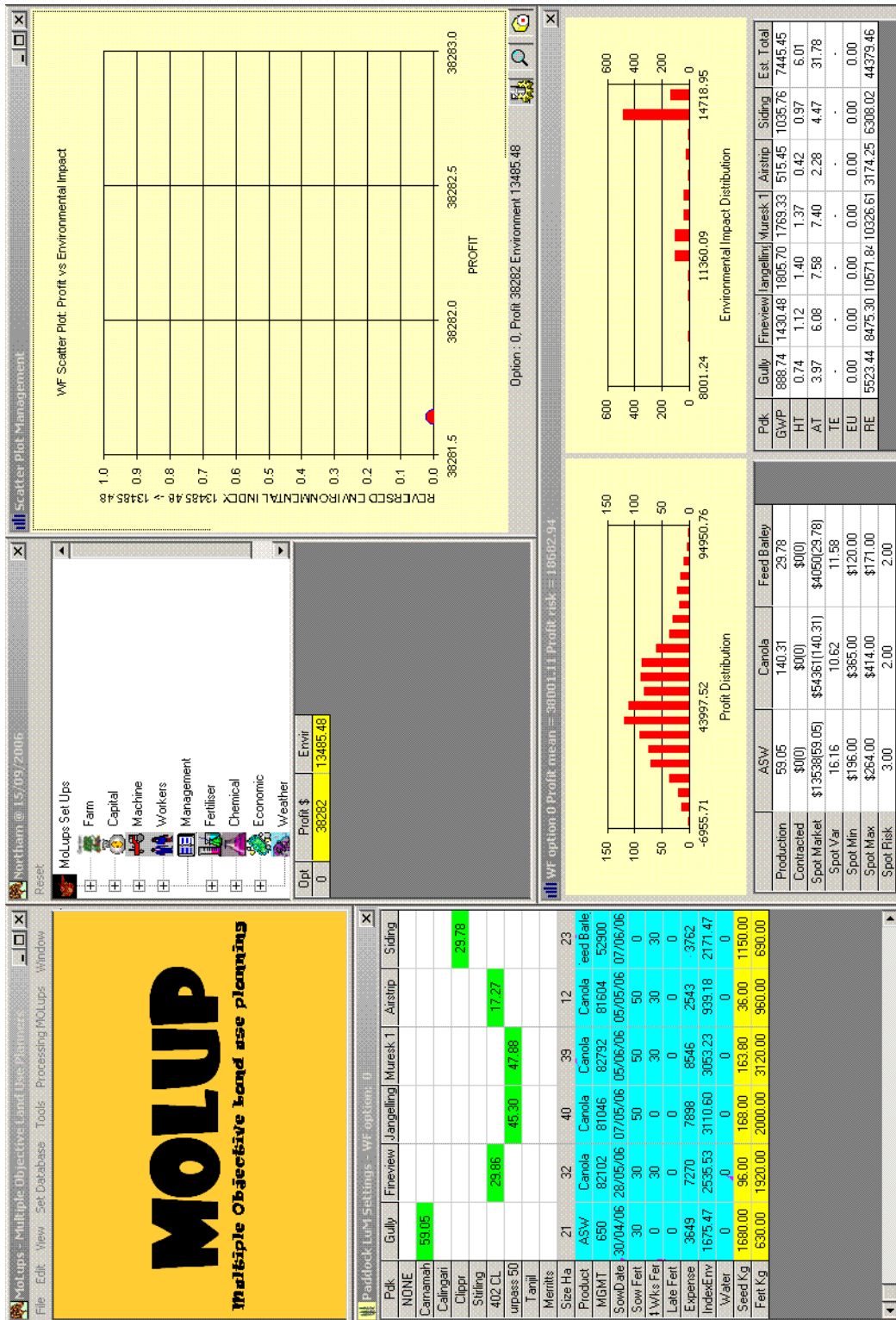

Figure 5.37 MOLup results for 15<sup>th</sup> September 2006 using simulated spot cash prices

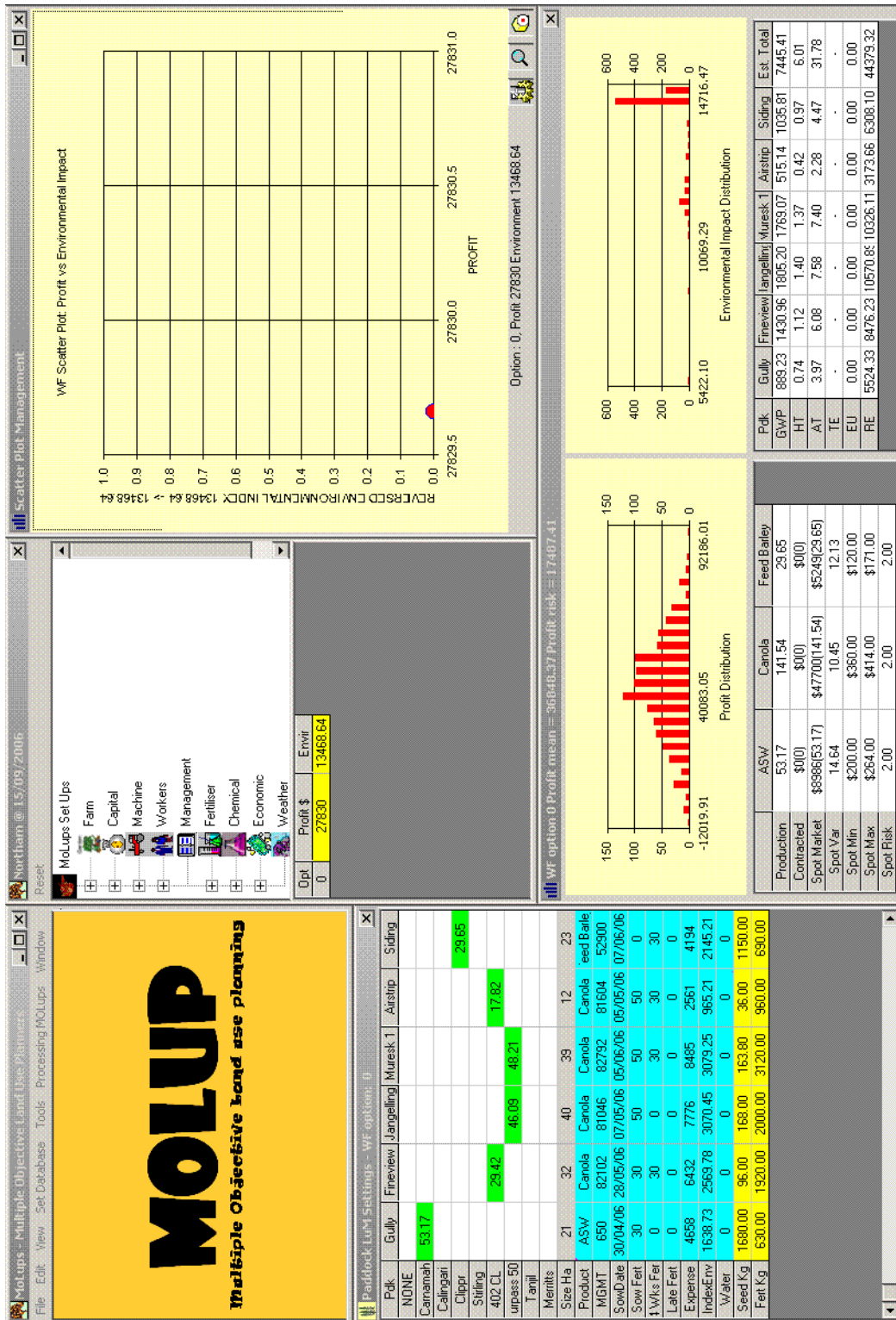

Figure 5.38 MOLUP results for 15<sup>th</sup> September 2006 using edited spot cash prices

## 5.6 Chapter Summary

In this chapter, a case study employing the *MOLup* program developed in this research, is presented and discussed. The case study is performed on the Muresk farm, near Northam, Western Australia, and is based on actual 2006 rainfall data. Eighty-six years (1920 - 2005) of historical rainfall data were used to forecast the most probable weather conditions, which in turn predicted the crop production for the season.

For this case study, the crop simulator WA Wheat (based on Beverley data) was used to represent Northam crop production. Beverley was chosen as a validated model as Northam was not available. The environmental impact values were evaluated using the *Grains Environmental Data Tool* (GEDT) simulator.

In this case study, *MOLup* was used at different points of time during the year at which farming decisions are traditionally made: the early season (January), the pre-sowing planning (March), the sowing window (April until July), and the post sowing window (July until September). At each decision point, the model provides updated management recommendations, which seem plausible given the characteristics of the evolving season. It should be noted that the 2006 crop season was not a typical and therefore excellent test-bed for the model.

Figure 5.39 provides a summary of the changes in recommendations produced by *MOLup* through the case study period. The model has clearly reacted appropriately to the changing seasonal (weather and market) conditions. At the start of the year all season types are valid, but as the year progresses and the growing season weather reveals itself, the possible season type reduces to types five and six.



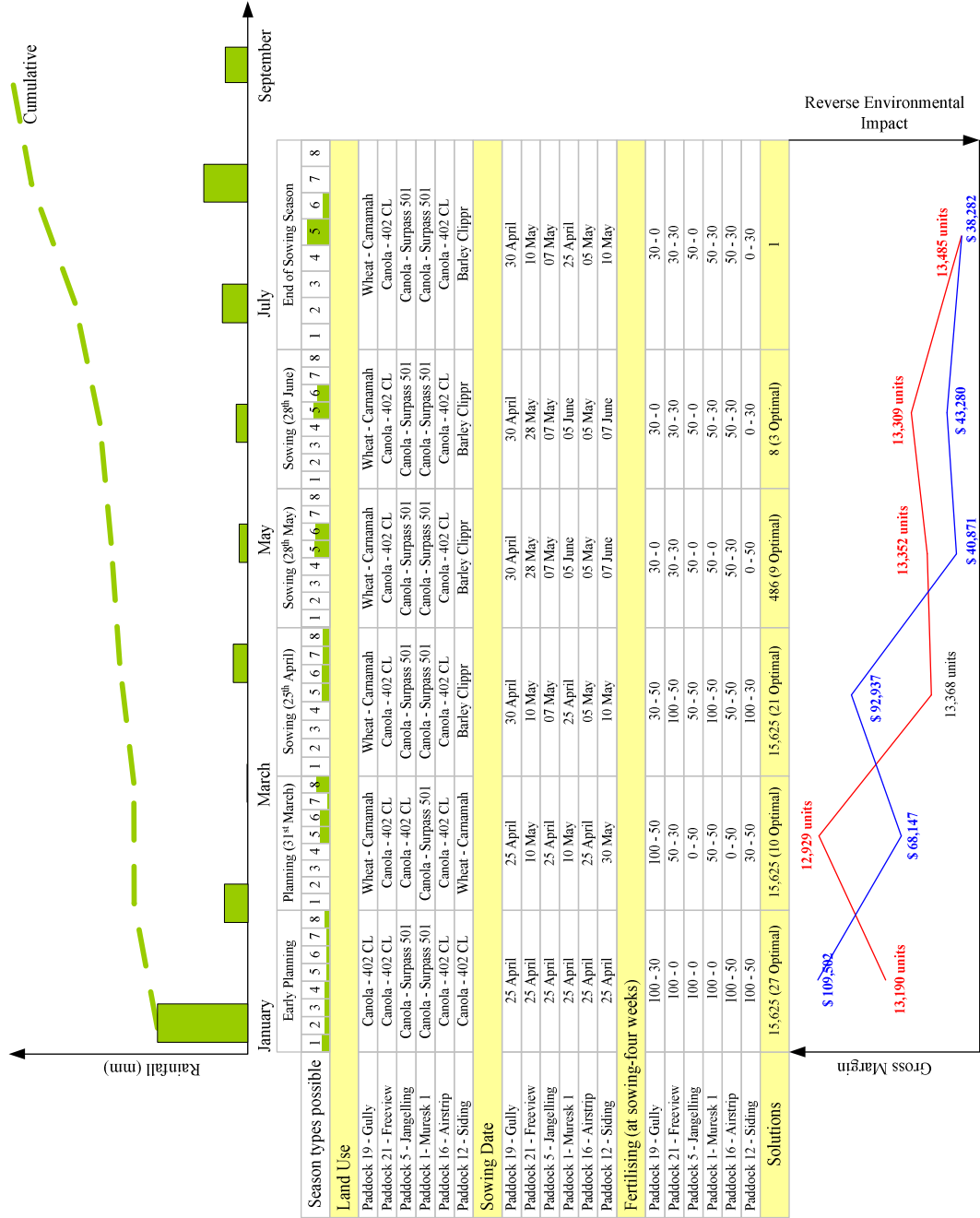

Figure 5.39 Summary of the case study results

The major impact of note is in the gross margin produced from the paddock. In January the optimum plan was anticipated to return \$109,502, but this drops to \$38,282 ( $\downarrow 65\%$ ) in the last runs of the model. Of interest is that the environmental impact changes only slightly and rises slightly from 13,190 units at the start of the planning process to 13,485 units ( $\uparrow 2.18\%$ ) at the end. This is due to the impact of diverse farm management decisions - especially the application of fertiliser - which, once made, cannot be reversed.

It is noticeable that the delayed break of season due to inadequate rainfall has impacted the sowing date, crop grown and fertiliser strategy. The crop choice for this case study seems to be dominated by canola. However, this may be caused by the limited number of crop rotations imposed on each paddock. It could also be caused by the fact that canola tends to be sown early in the season. As the year progresses, it can be seen that although canola still dominates, wheat and barley were also chosen as one of the best options for two different paddocks.

In addition, the lack of the variation in the chosen crops could also be because the current *MOLup* prototype has not been developed to incorporate physical crop rotation restrictions (see Section 4.3.1 and 4.3.4) in determining the most satisficing *WLuM* options.

It also needs to be acknowledged that changes to the threshold of the maximum number of *LuM* options would highly likely change the *WLuM* options offered by *MOLup*. For the case study of this thesis, the maximum number of paddock *LuM* options is restricted to ten. The options chosen provide the most optimum land-use planning (based on gross margin) per paddock. Due to the technology constraint when the case study was performed, it was necessary to curb the exponential growth of options in whole-farm land-use planning.

## CHAPTER 6

### CONCLUSIONS AND RECOMMENDATIONS

This research aimed to develop a prototype Land-use Decision Support System (LUDSS) that will aid the tactical farm management decision making process made by wheat-sheep farm managers. Current land-use decision making models do not provide a simultaneous picture of both the financial and the environmental impacts of farm management decisions. They also, in many cases, fail to capture the tactical decisions that are required during the crop growing period.

Land-use (farm) planning is a highly dynamic process. A land-use plan could be optimum at one point in time, but may not be at another point in time further into the implementation of the plan. This is due to the changes in the variables driving the decision-making process including external drivers, such as weather, markets, pests and diseases, as well as the interaction of these with the management actions taken to date such as the timing, type and date of application of fertiliser.

A LUDSS model needs to be able to capture the complex decision-making process such that tactical decisions can be made as the crop growing season develops and reveals itself in terms of the key drivers and their interaction with management decisions already made. The model should allow decision makers to explore multiple competing objectives in their search for the most satisficing land-use and management option on land management units. Furthermore, the developed model needs to be user-friendly and easy to navigate.

A homogenous land management unit (LMU) is crucial to successfully determining the most satisficing land-use management option. Warren (2007), in a parallel project to this research, developed a series of homogenous land management units (LMUs) by utilising airborne multi-spectral techniques, landform and field data. These LMUs were then used in the case study for this research to case study the LUDSS developed in this research.

## 6.1 Problem Description and Research Objectives

Farm planning is a very complex and challenging activity. Farm managers are required to make strategic and tactical decisions, which are influenced by a number of ever-changing external (to the business) factors. These factors can singularly, or in combination with the farm's biophysical environment, cause marked changes in production and environmental outcomes. Whole-farm decision-making occurs in this dynamic environment, when managers are required to develop and implement land-use plans for their properties at least annually. They are also required to monitor the implementation of their strategic plans. Once developed (usually in the period from the previous harvest up to the current seeding period), such plans do not remain static and will be continually updated based on changes in the production and market environment. This can be conceptualised as a narrowing cone (Figure 6.1).

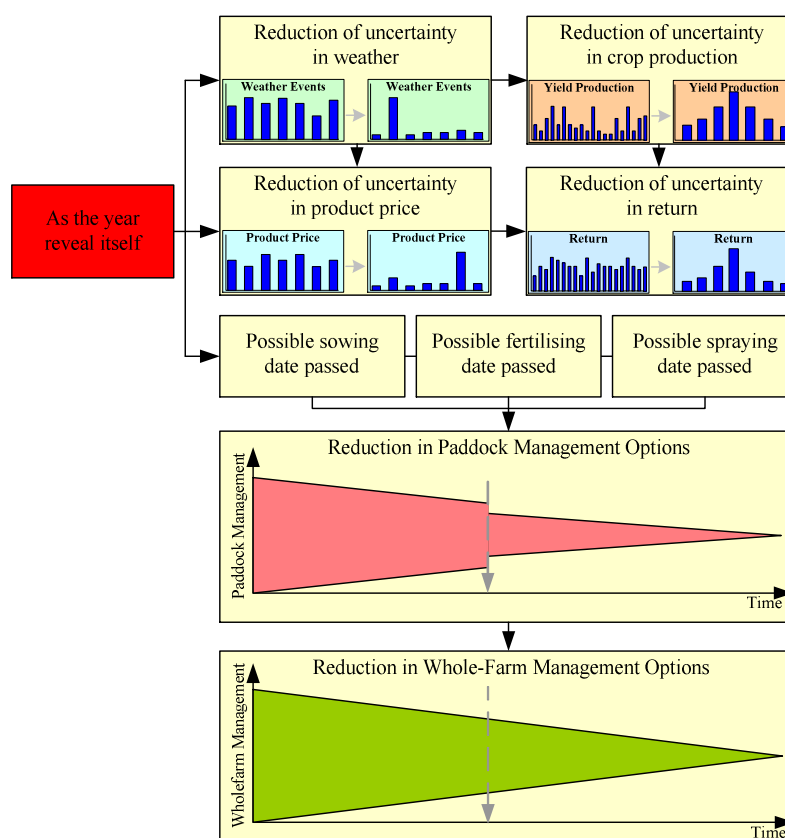

Figure 6.1 Foot print of the changes that happen during the year

Typically, at the beginning of the planning year, uncertainty is very high due to the lack of knowledge on significant drivers, such as weather and markets. In effect, farmers have a large range of possible land-use and production options. As the year

progresses, the increased confidence in information about weather and the market reduces the possible decision-making space. Coupled with this, as the planning period progresses, decisions have been made (e.g. which crop to sow), which further constrain decisions about the subsequent management and marketing of that crop.

The following specific objectives were identified for this research to develop a suitable LUDSS model to support tactical farm decision-making:

- **Modeling of decision objectives:** This aspect of the research requires identifying factors important in farm management, identifying the problem objective, and developing a decision-making model, which incorporates a trade-off between the two major competing objectives of maximising production and financial returns, while ensuring the environmental sustainability of the farm system to be adopted;
- **Developing a basic LUDSS model:** This aspect of the research initially required a review of the different optimisation techniques and identifying those suitable for the LUDSS model;
- **Incorporating risk and uncertainty:** Analysis and modeling of risk and uncertainty by assessing different risk analysis techniques and incorporating them into the optimisation model;
- **Flexible user interface:** Building a user interface to allow the model to be used by a wide audience ranging from extension officers to farmers.

This research has investigated the development of an innovative approach for an effective Land Use Decision Support System (LUDSS) based on the research objective listed above. Sections 6.2 and 6.3 outline the research outcomes. These research outcomes have led to a hypothesis, and formed a set of recommendations for further development in future research (Section 6.4).

## **6.2 Research Outcomes**

### **6.2.1 Capturing the decision-making environment**

An important aspect of farm management is to identify the farm manager's business objectives. It was determined early in the research that the decision-making model needs to incorporate multiple objectives rather than a single objective focused on profit maximisation alone. Analysis of the decision making environment found that

the most important objectives in whole-farm planning are to maximise the production and financial returns, whilst at the same time ensuring the environmental sustainability of the farm system. Both objectives directly address the long term sustainability of the business. It is recognised that there is a wide range of other family, lifestyle and status objectives. These have been excluded from this research as they are non-commensurate but could be added in the future.

There are a wide range of approaches available for multiple-objective decision-making models. The two major approaches are Multiple Objective Decision-Making (MODM) and Multiple Attribute Decision-Making (MADM). The MODM approach explores the large continuous solution space, in order to find the optimum, or “most satisficing”, solutions. On the other hand, the MADM approach usually has a discrete decision space, in which a set of alternatives and a set of attributes have been pre-specified prior to the commencement of the decision-making procedure. Based on the nature of this research, the search area for the problem objective is a non-discrete solution space. Analysis of the decision making space concluded that the problem was best analysed as a MODM instead of a MADM problem.

The literature review found that there are four suitable MODM approaches. These varied according to the type of preference information and the time *when* the preferences were articulated by the decision-maker: never, prior (*á Priori*), progressively or after (*á Posteriori*) the solution is generated. The *Never* articulate was deemed to be unfit due to its inability to incorporate crucial preference information supplied by the decision-maker. The *á Priori* articulation was discounted because it tends to simplify the multiple criteria problem into a scalar vector and eliminate the dynamic judgemental environment experienced by the decision. The *Progressive* approach was thought to be unsuitable due to its iterative nature. The *á Posteriori* articulation approach was judged to be superior since it allows decision-makers to have the freedom to assert their preference where and when they decide.

The prototype model developed consists of two stages: searching the solution space and subsequently selecting the most satisficing solution(s). Two major search methods have been used: the exhaustive and the evolutionary search methods. The *Exhaustive Search* method has proved a reliable method to ensure that all possible suitable solutions are searched prior to the selection of the optimum solution. On the

other hand, the evolutionary search method, *Evolutionary Algorithm*, is a non-systematic search method that does not explore the problem space completely. It is attractive because a search will reach its “optimum” solution faster and requires less computer processing ability.

Two methods are used to perform the selection of the most satisficing solution: the Pareto Optimisation and the Visualisation approach. The Pareto Optimisation is used to find the most satisficing management options by identifying *superior* solutions among *inferior* solutions based on the problem objective. In this case, *superior* solutions are the whole-farm management option (*WLuM*) solutions that are not dominated by any other solution based on the set of objectives: *Profit (Pt)* and *Reversed Environmental Impact (EI)*. Visualisation approaches are carried out by designing the output visualisation in a manner that aids the decision-maker to select their solution without placing too many constraints on them. Further elaboration can be found in Section 6.2.4.

### 6.2.2 Developing a LUDSS model

This research reviewed different optimisation techniques and identified suitable optimisation methods for the LUDSS model. Sections 2.4, 2.5, 2.6 and 2.8.1 describe the process of determining the most appropriate decision-making approach for the defined problem.

The initial focus of this research was on developing an Evolutionary Algorithm (EA) approach such as Genetic Algorithm (GA), as a possible search engine. An EA is a non-systematic search method. Generally, these methods do not explore the problem space completely which means a typical EA model is capable of reaching its “optimum” solution faster and requires less computer processing. However, it was found that EA model has a number drawbacks:

- EA models are not always able to identify optimal trade-offs, instead they identify a “good approximation” since the basic concept of EA models is to compare any solution discovered to previously identified solutions;
- A typical EA model uses a threshold or condition as the criterion to stop the search. The model will stop searching after a threshold or condition is reached,

such as when a number of search iterations has been reached. Therefore, the “best” solution obtained by the model is not always the optimal solution;

- An EA model requires parameter setting for every different case, for example the number of search iterations allowed. This means that the solution for one case is usually highly influenced by the initial parameter settings. A trivial change to the value of an initial parameter can lead to a significantly different solution. Generally, a suitable parameter can be determined by trial and error, but this process requires a highly-trained user. Self-adaptive approaches have been invented to overcome these problems, but there are still many factors that need to be resolved and developed.

The drawback of the EA model stated above were significant enough to cease further development of the model in this research. The research was then refocused on exhaustive search techniques, which attempt to ensure that all possible suitable solutions are searched prior to the selection of the optimum solution. The main drawback of the exhaustive search techniques is that they consume a massive amount of computer memory space and time. Although it can be argued that with advances in computer technology this weakness is becoming less crucial, it was however, a limiting factor in this research.

### 6.2.3 Analysis and modelling of risk and uncertainty

The farm decision-making environment is one in which there are high levels of risk and uncertainty. Therefore it is crucial for an effective LUDSS model to incorporate risk and uncertainty element.

Monte Carlo is a well-known knowledge-based stochastic simulation approach. Unlike the other methods investigated, Monte Carlo analysis is not restricted to linear, monotonic or continuous events. It is also capable of analysing a system based on a range of possible scenarios. In addition, the approach is able to incorporate the expert subjective knowledge that the farmer is able to bring to the decision space. Therefore, Monte Carlo analysis was used in this research to model risk and uncertainty.



#### 6.2.4 Building a user interface

The *MOLup* model was developed based on the conceptual model presented in Chapter 4 using Visual Basic 6 (Microsoft 2003) and ESRI MapObjects (ESRI 1999). Graphical User Interface (GUI) technology was used to allow a seamless interface between the user and the model. An easy-to-use user interface, including items such as dialog boxes, was developed to allow the user to easily use the application. *MOLup*'s GUI provides a number of menus that allow the user to edit, view, set and analyse data, and to run *MOLup* processes. It allows the user to:

- Establish the initial settings for the farm, such as location, number of paddocks, crop history, commodity market information, soil attributes, fertiliser and pesticide properties, farming activities, simulation date and parameter settings;
- Connect to all of the *MOLup* market, fertiliser and pesticide, weather and crop production databases;
- View and update the settings and dataset utilised by *MOLup* in its simulation process;
- Perform the forecasting of crop production based on the weather conditions;
- Run the *MOLup* simulation processes.

The output from the model is presented as scatter plots, histograms, text and a map (see Section 4.6.3 and Chapter 5). This output allows the user to select the most satisficing solution from all possible optimum solutions based on the user's preferences and circumstances. Figure 6.2 shows us one such output. In this case, it is used to present pre-selected land-use management options for a specific paddock including the profit as well as the environmental impact value for each of the investigated options. This allows the user the chance to visualise a number of options and select a preferred one for that paddock.

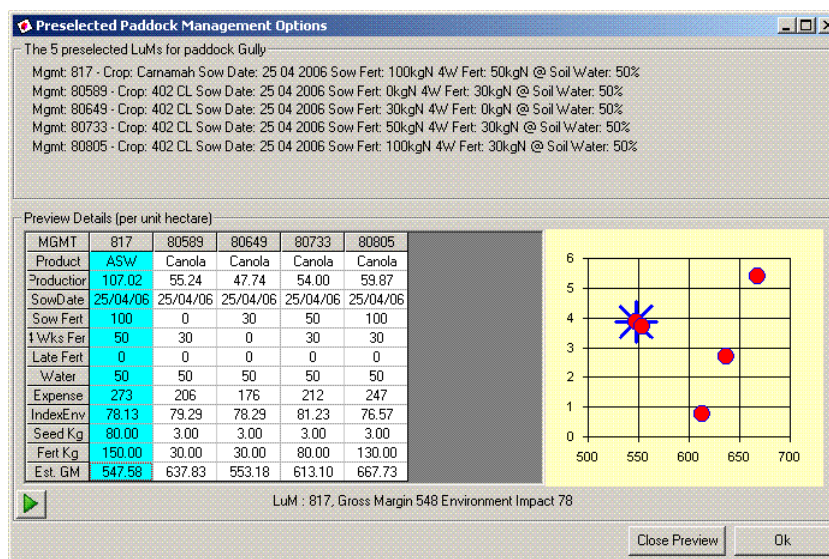

Figure 6.2 Pre-selected land-use management options for *Gully*

### 6.3 *MOLup* as a Tool

*MOLup* is a prototype model developed to help obtain optimum whole-farm management strategies involving an interactive tactical decision-making process. The prototype mimics the way in which a farm manager and/or a consultant would search for optimal solutions at a paddock-by-paddock and whole-farm level. It incorporates the elements that influence the decision-making process at different times of the year. It also takes into account the risk and uncertainty associated with the key drivers of farm production, like weather and market information, which influence the course of management strategies. The model maximises profit and minimises the negative environmental impacts that may result from the production system selected.

*MOLup* can run at any point in time to determine possible optimum solutions for any provided scenario. The prototype is developed in such a way that it is able to freely incorporate different scenarios, such as weather, market, crop choice, paddock history and management actions within season. This allows the user to run *MOLup* with many different possible scenarios and obtain the potential optimum whole-farm management strategies accordingly. This ability is a crucial feature as it provides flexibility to the farm manager in their decision making when an unexpected event has occurred. It also allows them to explore possibilities on their farm earlier on in the sowing year.

It needs to be acknowledged that a full validation with a real world farming system is outside the scope of this thesis. This is firstly due to the fact that some of the yield production data utilised in the case study were calibrated data, not directly simulated data. WA Wheat is the crop production simulator utilised for the case study. This simulator only provides wheat yield as an output. Subsequently, canola, lupins and barley production values are all derived from a calibration of WA Wheat data. However, the calibration does not directly derive quality parameters in the same way. This means that for these three crops quality is based on assumption only. Secondly, appropriate historical price data which is used as part of the input to estimate the spot cash price of 2006, is unavailable. For these reasons, a validation with a real world situation would be inappropriate.

#### **6.4 Recommendation for Future Work**

This research has developed a prototype model of whole-farm land-use decision-making. It is a prototype model and as such needs further development that was outside the scope of this research.

It is hypothesised that a more comprehensive Land Use Decision Support System (LUDSS) can be realised if the model is improved in three major areas. These major areas of further development that have been identified and should become a focus for future research are:

- Input data improvement;
- Model enhancement;
- Hardware requirement.

##### **6.4.1 Input data improvement**

As stated in the summary of Chapter 5, one of the major shortcomings of the model presented here was the lack of a suitable crop production simulation model. Currently, *MOLup* uses WA Wheat as the crop production simulator. WA Wheat is a wheat production database which uses the Agricultural Production System Simulator (APSIM) to produce Western Australian wheat production in response to a factorial construction of agronomic options for 102 years (Fisher *et al.* 2001b).

Although WA Wheat is a superior crop simulator, it only provides wheat yield as an output. Consequently canola, lupins and barley production values are all derived from calibrations of WA Wheat data. A more generalised simulator such as APSIM, would enable a wider range of crops to be directly simulated and provide a more reliable input to the *MOLup* model.

In addition, in an ideal situation the selling price of yield production is correlated to the quality of the yield production itself. However, for this research, it was impractical to calibrate the quality of the crop based on the data provided by WA Wheat. WA Wheat simulates wheat yield production and its protein level. Since simulator models were not available for the other crops of interest, it was impossible to directly derive quality parameters in the same way. Therefore only one quality is assumed for the rest of the other crops of interest.

The success of *MOLup* in determining the most satisficing whole-farm management options depends on the accurate market information. Due to constraints on time and resources with this project, a set of historical spot price data from 1989 to 2005 was generated based on weather conditions during these years. The generated dataset was then used to estimate the spot cash price of 2006. For a more accurate and comprehensive result, it would be profoundly useful if real world market data were used as part of the *MOLup* input data for the case study.

#### 6.4.2 Model enhancement

There are a number of improvements which relate to more explicitly capturing the real farm management decision-making framework. These include the addition of routines that explicitly incorporate crop rotations; more detailed constraints on available capital, labour and machinery; the incorporation of livestock options; and enhancing the crop marketing component of the model to allow dynamic explanation of the full range of marketing options over the cropping year.

In Section 4.3.1 it was noted that *MOLup* does not explicitly incorporate a dynamic crop rotation capability. Instead, it only takes into account the crop rotation incorporated in the crop production simulator, WA Wheat. This is a major shortcoming and may have caused the lack of variation in the crops selected in the

case study result (see Section 5.6). Two options are proposed for future enhancement:

- Incorporate specific crop rotation constraints in the *MOLup* model;
- As discussed above, develop crop simulator models that explicitly incorporate the flow forward (negative and positive) impacts of rotation decisions.

The second option would be the preferred route for future research as it captures the dynamic nature of the rotation decision.

The current prototype assumes that any machinery, labour and capital required is available and does not impose any constraint to the decisions on land-use and tactical management. Whilst this is an acceptable assumption on many WA Wheatbelt farms, it is not always realistic with labour and machinery allocation at crucial decision points such as seeding and harvest. This could be rectified by the inclusion of a detailed database on the farm's machinery and labour position and the capabilities for each to provide services to explicit land-use operations. The database would then be linked to explicit constraints on labour and machinery. The inclusion of capital constraints would require the development of a constrained working capital module with at least monthly time steps.

Livestock has not been included in the current version of the model. Whilst this reflects the trend for WA Wheatbelt farmers to exclude livestock from their production systems because of decreasing returns, the model would be further enhanced by the inclusion of sheep enterprise options. The inclusion of livestock to a crop farm helps spread the risk and also provides an additional income, as well as a fertility transfer option. Ideally the sheep component should be a simulation model that allows a range of production options to be explored; for example wethers, breeding ewes, feed-lotting, *etc.*

The current model has been developed to explore tactical decision making within the growing season. A possible enhancement would be to expand the model into a multiple period whole-farm planning model. A multiple period whole-farm planning model would provide a better understanding on how decisions made in the current season might impact on farm sustainability in the future. This was beyond the scope of the current research and would require a substantial restructuring of the existing

model. Nevertheless, it is recommended that *MOLup* could be extended to handle multiple period whole-farm planning by utilising a “multi-stage” optimisation approach such as Dynamic Programming (DP). In this case, each sowing season of the whole-farm planning process is a sub-problem of the overall (multi-period) whole-farm planning. The sub-problems are then solved successively and thereby form a sequence of decisions which leads to an optimal solution of the problem.

*MOLup* assists the decision maker to obtain the most satisficing whole-farm management solution based on two different marketing options. The marketing of crops has become more complex especially since the removal of the single desk for wheat marketing in Australia. The number of marketing options has increased in range and complexity. Market alternatives can be categorised into three categories: cash contracts, derivative based products (futures and options contracts, commodity swaps, basis contracts), and pools. Currently, *MOLup* incorporates two of the numerous marketing alternatives: spot marketing (post-harvest) and forward contracting (pre-harvest). While the spot cash market is suitable when the price is favourable and at levels anticipated in the marketing plan, forward contracting is only suitable when the storage is tight and crop production is high and the market price reaches the managers target level. With a volatile market, the two marketing alternatives incorporated in *MOLup* are not always suitable to all situations, especially when there is a need to trade and change within the season as market conditions and the production scenarios change. The enhancement to the model would require an integration of more advanced and diverse marketing options (e.g. cash sale, forward contract, hedging with futures or options, commodity swaps, basis contracts, harvest and contract pools, and many others) depending on the grower’s requirements.

One of the main advantages of *MOLup* is its flexibility in expanding the objective. In most farm planning circumstances, risk is one of the most important factors to be considered by farm manager. Therefore, it is proposed that the model is enhanced by incorporating additional objectives and frontiers such as the second moment of profit and environmental impact distributions.

Moreover, although Evolutionary Algorithm (EA) based methods have their drawbacks, EA is not an inferior search algorithm. EA based methods are capable to search and determine an “optimum” solution in much less time than exhaustive search based methods. Moreover, EA models do not need to consider convexity/concavity and continuity of the decision problem. For this reason, EA based model such as *TuGAs* (*Tabu Search-Genetic Algorithm Search*) could be incorporated as a search option for the prototype. Nevertheless, this kind of model needs to be used with caution. Utilising an EA model to determine the optimum solution of a problem may require a number of trials to determine the best search parameters for each particular case study. Consequently, *MOLup* may need to be run by an expert. Moreover, EA search models do not guarantee that optimal trade-offs are found, since they only try to discover a good approximation.

#### 6.4.3 Hardware requirement

The *MOLup* model is a combinatorial optimisation problem which utilises the *Exhaustive Search* method to identify a solution. A typical farm planning decision-making process involves a huge number of potential activities and subsequent impacts. Each of these activities is comprised of a number of different choices, while the formation of the management recommendation for a paddock is done by permutating the choice given by each aspect within the management options. As such, the potential number of activities grows exponentially with each additional option. Any model will therefore be a compromise on reality. The current model attempts to not compromise on reality. Therefore it requires a high powered computer. The ongoing improvement in computer hardware technology and method (such as cloud computing and grid computing) means *MOLup* can easily be run on most personal computers. Moreover, this also means that a larger number of choices for each aspect within the management can be incorporated within *MOLup*.

## REFERENCES

- Abbass, H.A. (2002) The Self-Adaptive Pareto Differential Evolution Algorithm, *Proceedings of the 4th Congress on Evolutionary Computation (CEC'2002)*, Honolulu-Hawaii, USA, pp. 831-836.
- Abbass, H.A. and Sarker, R. (2002) The Pareto Differential Evolution Algorithm, *International Journal on Artificial Intelligence Tools*, Vol. 11, No. 4, pp. 531-552.
- Abrishamchi, A., Ebrahimian, A., Tajrishi, M. and Mariño, M.A. (2005) Case Study: Application of Multicriteria Decision Making to Urban Water Supply, *Journal of Water Resources Planning and Management, ASCE*, Vol. 131, No. 4, pp. 326-335.
- Access Excellence The National Health Museum (1999) *Chromosome (Graphics Gallery)*, [online]: <http://www.accessexcellence.org/RC/VL/GG/chromosome.html>, accessed (29 June 2005).
- Adesina, A.A. and Ouattara, A.D. (2000) Risk and Agricultural Systems in Northern Cote D'ivoire, *Agricultural Systems*, Vol. 66, No. 1, pp. 17-32.
- Adger, W.N. and Vincent, K. (2005) Uncertainty in Adaptive Capacity, *Comptes Rendus Geoscience*, Vol. 337, No. 4, pp. 399-410.
- Adiku, S.K., Carberry, P.S., Rose, C.W., McCown, R.L. and Braddock, R. (1993) Assessing the Performance of Maize (*Zea Mays*-Cowpea (*Vigna Unguiculata*) Intercrop under Variable Soil and Climate Conditions in the Tropics, *Proceedings of the 7th Australian Society of Agronomy Conference*, Adelaide, South Australia, Australia, September 1993, p. 382.
- Akpinar, N. (2003) Determination of Priorities of Land Use Types Using Simos Procedure and ELECTRE 1 Method in Sustainable Land Use Planning, *Journal of Agricultural Sciences*, Vol. 9, No. 2, pp. 234-242.
- Alba, E. and Tomassini, M. (2002) Parallelism and Evolutionary Algorithms, *IEEE Transactions on Evolutionary Computation*, Vol. 6, No. 5, pp. 443-462.
- Altham, W.A. (2003) *Grains Environmental Data Tool*, Pipeline, No. 4, December 2003.
- Anderle, C., Fedrizzi, M., Giove, S. and Fuller, R. (1994) Fuzzy Multiple Objective Programming Techniques in Modeling Forest Planning, *Proceedings of the 2nd European Congress on Fuzzy and Intelligent Technologies (EUFIT'94)*, Aachen, Germany, 20-23 September 1994, pp. 1500-1503.
- Andersson, J. (2001) Multiobjective Optimization in Engineering Design: Applications to Fluid Power Systems, *Doctor of Philosophy Thesis*, Division



of Fluid and Mechanical Engineering Systems, Department of Mechanical Engineering, Linköpings Universitet, Linköping, Sweden, 201 pp.

- Andersson, J. (2000) A Survey of Multiobjective Optimization in Engineering Design, *LiTH-IKP-R-1097*, Linköping University (Department of Mechanical Engineering), Linköping, Sweden, pp. 1-34.
- Angelidis, M.O. and Kamizoulis, G. (2005) Rapid Decision-Making Method for the Evaluation of Pollution-Sensitive Coastal Areas in the Mediterranean Sea, *Environmental Management*, Vol. 35, No. 6, pp. 811-820.
- Anselin, L. (1992) Spatial Data Analysis with GIS: An Introduction to Application in the Social Sciences, *Technical Report 92-10*, National Center for Geographic Information and Analysis, University of California, Santa Barbara, USA.
- Apland, J., Grainger, C. and Strock, J. (2004) Modelling Agricultural Production Considering Water Quality and Risk, *Staff Paper P04-13*, University of Minnesota (Department of Applied Economics, College of Agricultural, Food, and Environmental Sciences), Minnesota, USA.
- Asseng, S., Bar-Tal, A., Bowden, J.W., Keating, B.A., van Herwaarden, A., Palta, J.A., Huth, N.I. and Probert, M.E. (2002) Simulation of Grain Protein Content with Apsim-Nwheat, *European Journal of Agronomy*, Vol. 16, No. 25-42
- Asseng, S., Fillery, I.R.P., Anderson, G.C., Dolling, P.J., Dunin, F.X. and Keating, B.A. (1998a) Use of the Apsim Wheat Model to Predict Yield, Drainage, and N<sub>2</sub>O Leaching for a Deep Sand, *Australian Journal of Agricultural Research*, Vol. 49, No. 3, pp. 363-377.
- Asseng, S., Keating, B.A., Fillery, I.R.P., Gregory, P.J., Bowden, J.W., Turner, N.C., Palta, J.A. and Abrecht, D.G. (1998b) Performance of the Apsim-Wheat Model in Western Australia, *Field Crops Research*, Vol. 57, No. 2, pp. 163-179.
- Australian Banker's Association Inc. (2004) A Practical Guide to Farm Financial Planning and Management, *Financing Your Farm*, Australian Banker's Association Inc., Australia.
- AWB (2005) AWB Limited Wheat Quality Standards 2005-2006 Graincorp Primary Chart, AWB.
- Bäck, T., Eiben, A.E. and Vaart, v.d. (2000) An Empirical Study on Gas "Without Parameters", *Proceedings of the 6th International Conference on Parallel Problem Solving from Nature (PPSN VI)*, Paris, France, 18-20 September 2000, pp. 315-324.
- Bäck, T., Hammel, U. and Schwefel, H.P. (1997) Evolutionary Computation: Comments on the History and Current State, *IEEE Transactions on Evolutionary Computation*, Vol. 1, No. 1, pp. 3-17.

- Bäck, T. and Schwefel, H.P. (1996) Evolutionary Computation: An Overview, *Proceedings of the 3rd IEEE International Conference on Evolutionary Computation (IEEE/ICEC'96)*, Nagoya University, Japan, 20-22 May 1996, pp. 20-29.
- Baesler, F.F. and Sepúlveda, J.A. (2001) Healthcare II: Multi-Objective Simulation Optimization for a Cancer Treatment Center, *Proceedings of the 33rd Winter Simulation Conference*, Arlington, Virginia, USA, 9 -12 December 2001, pp. 1405-1411.
- Baker, S.W. (1997) Risk Management in Major Projects, *Doctor of Philosophy Thesis*, Department of Civil and Environmental Engineering, University of Edinburgh, Edinburgh, UK, 328 pp.
- Balakrishnan, K. (1993) Parallel Genetic Algorithms, Premature Convergence and the Ncube, *Coms 625x Term Project*, pp. 1-19.
- Bana E Costa, C.A., Stewart, T.J. and Vansnick, J.-C. (1997) Multicriteria Decision Analysis: Some Thoughts Based on the Tutorial and Discussion Session of the Esigma Meetings, *European Journal of Operational Research*, Vol. 99, No. 28-37.
- Barao, S.M. and Hughes, J.P. (1999) Decisionmaking Principles for Part-Time Farmers, *Fact Sheet 651*, Cooperative Extension Service, University of Maryland at College Park, Maryland, USA.
- Baroni, P. and Vicig, P. (2005) An Uncertainty Interchange Format with Imprecise Probabilities, *International Journal of Approximate Reasoning*, Vol. 40, No. 3, pp. 147-180.
- Baroni, P. and Vicig, P. (2003) Transformations from Imprecise to Precise Probabilities, *Proceedings of the 7th European Conference on Symbolic and Quantitative Approaches to Reasoning with Uncertainty (ECSQARU'2003)*, Aalborg, Denmark, 2-5 July 2003, pp. 37-49.
- Basnet, B.B., Apan, A.A. and Raine, S.R. (2001) Selecting Suitable Sites for Animal Waste Application Using a Raster GIS, *Environmental Management*, Vol. 28, No. 4, pp. 519-531.
- Beasley, D., Bull, D.R. and Martin, R.R. (1993) An Overview of Genetic Algorithms: Part 2, Research Topics, *University Computing*, Vol. 15, No. 4, pp. 170-181.
- Beim, G. and Lévesque, M. (2004) Selecting Projects for Venture Capital Funding: A Multiple Criteria Decision Approach, *Proceedings of the 17th International Conference on Multiple Criteria Decision Analysis (MCDM 2004)*, Whistler, British Columbia, Canada, 6-11 August 2004.
- Bell, D.E. (1985) Disappointment in Decision Making under Uncertainty, *Operations Research*, Vol. 33., pp. 1-27.

- Bellman, R. (1957) *Dynamic Programming*, Princeton University Press, Princeton, New Jersey, USA, 342 pp.
- Ben Abdelaziz, F. and Krichen, S. (2005) An Interactive Method for the Optimal Selection Problem with Two Decision Makers, *European Journal of Operational Research*, Vol. 162, No. 3, pp. 602-609.
- Benayoun, R., de Montgolfier, J., Tergny, J. and Larichev, O. (1971) Linear Programming with Multiple Objective Functions: Steo Method (Stem), *Mathematical Programming*, Vol. 1, No. 3, pp. 366-375.
- Benayoun, R., Roy, B. and Sussman, N. (1966) *Manual De Reference Du Programme ELECTRE*, Direction Scientifique, SEMA, Paris, France.
- Bessaou, M., Petrowski, A. and Siarry, P. (2000) Island Model Cooperating with Speciation for Multimodal Optimization, *Proceedings of the 6th International Conference on Parallel Problem Solving from Nature (PPSN VI)*, Paris, France, 18-20 September 2000, pp. 437-446.
- Beyer, H.G. and Deb, K. (2001) On Self-Adaptive Features in Real-Parameter Evolutionary Algorithms, *IEEE Transactions on Evolutionary Computation*, Vol. 5, No. 3, pp. 250-270.
- Beyer, H.G., Schwefel, H.P. and Wegener, I. (2002) How to Analyse Evolutionary Algorithms, *CI-139/02*, Fachbereich Informatik, Universitat Dortmund, Germany, Dortmund, Germany, pp. 1-30.
- Bladt, J. (2002) Multiobjective Land Use Optimisation Using Evolutionary Algorithms, *Master of Science in Biology Thesis*, Department of Systematic Botany, University of Aarhus, Institute of Biology, Nordlandsvej, Denmark, 86 pp.
- Blickle, T. and Thiele, L. (1996) A Comparison of Selection Schemes Used in Evolutionary Algorithms, *Evolutionary Computation*, Vol. 4, No. 4, pp. 361-394.
- Blickle, T. and Thiele, L. (1995) A Comparison of Selection Schemes Used in Genetic Algorithms, *TIK-Report No. 11*, Computer Engineering and Networks Laboratory (TIK), Swiss Federal Institute of Technology (ETH), Zurich, Switzerland.
- Blum, C. and Roli, A. (2003) Metaheuristics in Combinatorial Optimization: Overview and Conceptual Comparison, *ACM Computing Surveys (CSUR)*, Vol. 35, No. 3, pp. 268-308.
- Bonham-Carter, G.F. (1996) *Geographic Information System for Geosciences: Modelling with GIS*, Pergamon Press, Oxford, UK.

- Boston, K. and Bettinger, P. (2001) Development of Spatially Feasible Forest Plans: A Comparison of Two Modeling Approaches, *Silva Fennica*, Vol. 35, No. 4, pp. 425-435.
- Brans, J.P. and Vincke, P. (1983) A Preference Ranking Organization Method (the Promethee Method for Multiple Criteria Decision Making), *Management Science*, Vol. 31, pp. 647-656.
- Briassoulis, H. (2000) *Analysis of Land Use Change: Theoretical and Modeling Approaches*, [online]: <http://www.rri.wvu.edu/WebBook/Briassoulis/contents.htm>, accessed (6 May 2003).
- Brownlee, J. (2004) Parallel Niching Genetic Algorithms: A Crowding Perspective, *Minor Thesis*, Australia Centre for Intelligent Systems and Complex Processes (CISCP), Faculty of Information and Communication Technologies (ICT), School of Information Technology, Swinburne University of Technology, Victoria, Australia, 93 pp.
- Brumelle, S., Granot, D., Halme, M. and Vertinsky, I. (1998) A Tabu Search Algorithm for Finding Good Forest Harvest Schedules Satisfying Green-up Constraints, *European Journal of Operational Research*, Vol. 106, No. 2-3, pp. 408-424.
- Bureau of Meterology (2004) *Averages for Beverley*, [online]: [http://www.bom.gov.au/climate/averages/tables/cw\\_010515.shtml](http://www.bom.gov.au/climate/averages/tables/cw_010515.shtml), accessed (18 August 2005).
- Cacho, O.J., Bywater, A.C. and Dillon, J.L. (1999) Assessment of Production Risk in Grazing Models, *Agricultural Systems*, Vol. 60, No. 2, pp. 87-98.
- Cantu-Paz, E. (1995) A Summary of Research on Parallel Genetic Algorithms, *Technical Report IlliGAL 95007*, University of Illinois at Urbana-Champaign (GA Laboratory), Urbana-Champaign, Illinois, USA.
- Carberry, P.S. (2001) Apsim: The Science, the Program and Derivative Products, FARMSCAPE Training and Accreditation documentation, 3.
- Carberry, P.S. and Abrecht, D.G. (1991) "Tailoring Crop Models to the Semi-Arid Tropics", in: *Climatic Risk in Crop Production: Models and Management for the Semi-Arid Tropics and Subtropics*, Muchow, R. C. & Bellamy, J. A. (eds.), CAB International, Wallingford, pp. 157-182.
- Carlton, C., Giove, S., Agostini, P., Critto, A. and Marcomini, A. (2004) The Role of Multi-Criteria Decision Analysis in a Decision Support System for Rehabilitation of Contaminated Sites (the Desyre Software), *Proceedings of the 2nd Biennial Meeting of the International Environmental Modelling and Software Society (iEMSs'2004): Complexity and Integrated Resources Management*, University of Osnabrück, Germany, 14-17 June 2004.

- Carroll, S., Goonetilleke, A. and Dawes, L. (2004) Framework for Soil Suitability Evaluation for Sewage Effluent Renovation, *Environmental Geology*, Vol. 46, No. 2, pp. 195-208.
- Catrinu, M.D. (2006) Decision Aid for Planning Local Energy Systems Application of Multi-Criteria Decision Analysis, Department of Electrical Power Engineering, Faculty of Information Technology, Mathematics and Electrical Engineering, , Norwegian University of Science and Technology, Trondheim, Norway, 198 pp.
- Cavicchio, D.J. (1970) Adaptive Search Using Simulated Evolution, *Doctor of Philosophy Thesis*, Computer and Communication Sciences Department, University of Michigan, Michigan, USA, 206 pp.
- Cedeño, W. and Vemuri, V.R. (1999) Analysis of Speciation and Nicheing in Multi-Niche Crowding Genetic Algorithms, *Theoretical Computer Science*, Vol. 222, pp. 177-197.
- Chakhar, S. and Martel, J.M. (2003) Enhancing Geographical Information Systems Capabilities with Multi-Criteria Evaluation Functions, *Journal of Geographic Information and Decision Analysis*, Vol. 7, No. 2, pp. 47-71.
- Chang, N.B., Wen, C.G. and Chen, Y.L. (1997) A Fuzzy Multi-Objective Programming Approach for Optimal Management of the Reservoir Watershed, *European Journal of Operational Research*, Vol. 99, pp. 289-302.
- Chapman, S.C., Hammer, G.L. and Meinke, H. (1993) A Sunflower Simulation Model: I Model Development, *Agronomy Journal*, Vol. 85, pp. 725-735.
- Chauncey, T.K., Ching, J.F. and Yanagida (1985) *Production Economics: Mathematical Development and Applications*, Transaction Publishers, 400 pp.
- Chen, S.Q. (2000) Comparing Probabilistic and Fuzzy Set Approaches for Design in the Presence of Uncertainty, *Doctor of Philosophy Thesis*, Aerospace Engineering, Virginia Polytechnic Institute and State University, Blacksburg, Virginia, USA, 140 pp.
- Chiwiacowsky, L.D., de Campos Velho, H.F., Preto, A. and Stemphany, S. (2004) Identifying Initial Condition in Heat Conduction Transfer by a Genetic Algorithm: A Parallel Approach, *Proceedings of the XXIV Iberian Latin-american Congress on Computational Methods in Engineering (CILAMCE-2003)*, Ouro Preto (MG), Brazil, 29-31 October 2003.
- Chowdary, B.V. and Slomp, J. (2002) Production Planning under Dynamic Product Environment: A Multi-Objective Goal Programming Approach, *02A12*, University of Groningen (Department of Production Systems Design, Faculty of Management & Organization), Groningen, the Netherlands, pp. 1-48.

- Chuenpichai, K., Chuenpichai, S. and Somrang, A. (2002) GIS and Expert System Integration for Land Development Village, Thailand, *Proceedings of the 22nd Annual ESRI International User Conference*, San Diego, California, USA, 8–12 July 2002.
- Chuvieco, E. (1993) Integration of Linear Programming and GIS for Land-Use Modelling, *International Journal of Geographical Information Systems*, Vol. 7, No. 1, pp. 71-83.
- CIRL (2003) *Search*, [online]: <http://cirl.uoregon.edu/research/search.html>, accessed (11 June 2005).
- Cobb, B.R. and Shenoy, P.P. (2003) A Comparison of Methods for Transforming Belief Function Models to Probability Models, *Proceedings of the 7th European Conference on Symbolic and Quantitative Approaches to Reasoning with Uncertainty (ECSQARU'2003)*, Aalborg, Denmark, 2-5 July 2003, pp. 255-266.
- Cocks, K.D. (1968) Discrete Stochastic Programming, *Management Science*, Vol. 15, No. 1, pp. 72-81.
- Coello Coello, C.A. (2000a) Multiobjective Optimization of Trusses Using Genetic Algorithms, *Computer Structures*, Vol. 75, No. 6, pp. 647-660.
- Coello Coello, C.A. (2000b) An Updated Survey of GA-Based Multiobjective Optimization Techniques, *ACM Computing Surveys (CSUR)*, Vol. 32, No. 2, pp. 109-143.
- Coello Coello, C.A. (1999) An Updated Survey of Evolutionary Multiobjective Optimization Techniques : State of the Art and Future Trends, Special Session on Multiobjective Optimization, *Proceedings of the 1st Congress on Evolutionary Computation (CEC'1999)*, Mayflower Hotel-Washington D.C., USA, July 1999, pp. 3-13.
- Colby, C. (1996) *Introduction to Evolutionary Biology*, [online]: <http://www.talkorigins.org/faqs/faq-intro-to-biology.html>, accessed (21 July 2005).
- Corne, D.W., Knowles, J.D. and Oates, M.J. (2000) The Pareto Envelope-Based Selection Algorithm for Multiobjective Optimisation, *Proceedings of the 6th International Conference on Parallel Problem Solving from Nature (PPSN VI)*, Paris, France, 18-20 September 2000, pp. 839-848.
- Craighurst, R. and Martin, W.N. (1995) Enhancing GA Performance through Crossover Prohibitions Based on Ancestry, *Proceedings of the 6th International Conference on Genetic Algorithms (ICGA'95)*, Pittsburgh, Pennsylvania, USA, 15-19 July 1995, pp. 130-135.
- Cramer, N.L. (1985) A Representation for the Adaptive Generation of Simple Sequential Programs, *Proceedings of the 1st International Conference on*

- Genetic Algorithms (ICGA'85)*, Carnegie Melon University, Pittsburgh, USA, July 1985, pp. 183-187.
- Critto, A., Giove, S., Nadal, N., Samiolo, M., Carlon, C., Silvoni, S., Foramiti, S. and Marcomini, A. (2002) Desyre - Decision Support System for Rehabilitation of Contaminated Sites: Objectives and Structure, *Proceedings of the 1st Biennial Meeting of the International Environmental Modelling and Software Society (iEMSs'2002): Integrated Assessment and Decision Support*, Lugano, Switzerland, 24-27 June 2002, pp. 211-216.
- Cvetkovic, D. (2000) Evolutionary Multi-Objective Decision Support Systems for Conceptual Design, *Doctor of Philosophy Thesis*, School of Computing, University of Plymouth, Plymouth, UK, 108 pp.
- Daniel, M. (2005) On Probabilistic Transformations of Belief Functions, *Technical report No. 934*, Institute of Computer Science, Academy of Sciences of the Czech Republic, Prague, Czech Republic.
- Darwin, C. (1958) *The Origin of Species - by Means of Natural Selection, or, the Preservation of Favoured Races in the Struggle for Life*, W Clowes and Sons, London, UK, 480 pp.
- Das, I. and Dennis, J. (1998) A Closer Look at Drawbacks of Minimizing Weighted Sums of Objectives for Pareto Set Generation in Multicriteria Optimization Problems, *Tech Report 96-36*, Rice University (Department Of Computational and Applied Mathematics), Houston, Texas, USA, pp. 96-36.
- de Jong, K.A. (1975) An Analysis of the Behavior of a Class of Genetic Adaptive Systems, *Doctor of Philosophy Thesis*, Computer and Communication Sciences Department, University of Michigan, Michigan, USA, 256 pp.
- de la Rosa, D. and Cromptvoets, J. (1998) Evaluating Mediterranean Soil Contamination Risk in Selected Hydrological Change Scenarios, *Agriculture, Ecosystems and Environment*, Vol. 67, No. 2-3, pp. 239-250.
- de Leeneer, I. and Pastijn, H. (2002) Selecting Land Mine Detection Strategies by Means of Outranking MCDM Techniques, *European Journal of Operational Research*, Vol. 139, No. 2, pp. 327-338.
- De, S., Pal, S.K. and Ghosh, A. (1998) Genotypic and Phenotypic Assortative Mating in Genetic Algorithm, *Information Sciences*, Vol. 105, No. 1-4, pp. 209-226.
- de Steiguer, J.E., Duberstein, J. and Lopes, V. (2003) The Analytic Hierarchy Process as a Means for Integrated Watershed Management, *Proceedings of the 1st Interagency Conference on Research in the Watersheds*, Benson, Arizona USA.
- de Weck, O.L. (2004) Multiobjective Optimization: History and Promise (Invited Keynote Paper, G12-2), *Proceedings of the 3<sup>rd</sup> China-Japan-Korea Joint*

*Symposium on Optimization of Structural and Mechanical Systems*, Kanazawa, Japan, pp. 30 October - 02 November 2004.

- Deb, K. (2001) *Multi-Objective Optimization Using Evolutionary Algorithms*, John Wiley & Sons, Chichester, UK, 518 pp.
- Deb, K. (1999) Multi-Objective Evolutionary Algorithms: Introducing Bias among Pareto-Optimal Solutions, 99002, Kanpur Genetic Algorithms Laboratory (KanGAL), Kanpur, India.
- Deb, K., Agrawal, S., Pratap, A. and Meyarivan, T. (2000) A Fast Elitist Nondominated Sorting Genetic Algorithm for Multi-Objective Optimization: Nsga-II, *Proceedings of the 6th International Conference on Parallel Problem Solving from Nature (PPSN VI)*, Paris, France, 18-20 September 2000, pp. 849-858.
- Deb, K. and Spears, W.M. (2000) "Speciation Methods", in: *Evolutionary Computation 2: Advanced Algorithms and Operators*, Bäck, T., Fogel, D. B. & Michalewicz, Z. (eds.), Institute of Physics.
- Dempster, A.P. (1968) A Generalization of Bayesian Inference, *Journal of Royal Statistical Society, Series B (Methodological)*, Vol. 30, pp. 205-247.
- Dempster, A.P. (1967a) Upper and Lower Probabilities Induced by a Multivalued Mapping, *Annales of Mathematical Statistics*, Vol. 38, pp. 325-339.
- Dempster, A.P. (1967b) Upper and Lower Probability Inference Based on a Sample from a Finite Univariate Population, *Biometrika*, Vol. 54, pp. 515-528.
- Dewan, T. (1988) Marketing Implications of Wheat Quality, *Proceedings of 17th Riverina Outlook Conference*, Wagga Wagga, New South Wales, Australia.
- Di Luzio, M., Srinivasan, R. and Arnold, J.G. (2000) *Avswat: An Arcview GIS Extension as Tool for the Watershed Control of Point and Non-Point Sources*, [online]: [http://www.giscafe.com/technical\\_papers/Papers/paper038/](http://www.giscafe.com/technical_papers/Papers/paper038/), accessed (23 August 2005).
- Dillon, C.R., Shearer, S.A. and Mueller, T. (2001) A Mixed Integer, Nonlinear Programming Model of Innovative Variable Rate Planting Date with Polymer Seed Coatings, *Proceedings of American Agricultural Economic Association 2001 Annual Meeting*, Chicago, Illinois, USA.
- Dorigo, M. and Di Caro, G. (1999) "The Ant Colony Optimization Meta-Heuristic", in: *New Ideas in Optimization*, Corne, D. W., Dorigo, M., Glover, F., Dasgupta, D., Moscato, P., Poli, R. & Price, K. V. (eds.), McGraw-Hill, London, UK, pp. 11-32.
- Dorigo, M., Maniezzo, V. and Colorni, A. (1996) Ant System: Optimization by a Colony of Cooperating Agents, *IEEE Transactions on Systems, Man, and Cybernetics - B: Cybernetics*, Vol. 26, No. 1, pp. 29-41.



- Doye, D. (2005) Goal Setting for Farm and Ranch Families, *OSU Extension Facts F-244*, Oklahoma Cooperative Extension Service, Division of Agricultural Sciences and Natural Resources, Oklahoma State University, Oklahoma, USA.
- Droste, S., Jansen, T. and Wegener, I. (2000) Dynamic Parameter Control in Simple Evolutionary Algorithms, *Proceedings of the 6th Workshop on the Foundations of Genetic Algorithms (FOGA'2000)*, San Francisco, California, USA, pp. 275-294.
- Drysdale, G. (2002) 'Phd Candidacy: Evaluating the Incorporation of Remote Sensing and Geographic Information Systems for Optimising Farming'.
- Dubois, D. and Prade, H. (2003) Possibility Theory and Its Applications: A Retrospective and Prospective View, *Proceedings of the 12th IEEE International Conference on Fuzzy Systems (FUZZ-IEEE'03)*, pp. 25-28.
- Dubois, D. and Prade, H. (1992) Possibility Theory as a Basis for Preference Propagation in Automated Reasoning, *Proceedings of the 1st IEEE International Conference on Fuzzy Systems (FUZZ-IEEE'92)*, pp. 821-832.
- Dubois, D. and Prade, H. (1989) Fuzzy Sets, Probability and Measurement, *European Journal of Operational Research*, Vol. 40, No. 2, pp. 135-154.
- Dubois, D., Prade, H. and Sandri, S. (1993) "On Possibility/Probability Transformations", in: *Fuzzy Logic: State of the Art*, Lowen, R. & Roubens, M. (eds.), Kluwer Academic Publication, Dordrecht, Amsterdam, the Netherlands, pp. 103-112.
- Ducey, M.J. (2001) Representing Uncertainty in Silvicultural Decisions: An Application of the Dempster-Shafer Theory of Evidence, *Forest Ecology and Management*, Vol. 150, No. 3, pp. 199-211.
- Ducey, M.J. and Larson, B.C. (1999) A Fuzzy Set Approach to the Problem of Sustainability, *Forest Ecology and Management*, Vol. 115, No. 1, pp. 29-40.
- Ducheyne, E. (2003) A Spatial Decision Support System Using Optimisation Techniques and Geographical Information Systems for Multiple Use Forest Management, *Doctor of Philosophy Thesis*, Department of Forest and Water Management, Faculty of Agricultural and Applied Biological Sciences, Ghent University, Ghent, 273 pp.
- Duflo, E. (2003) Poor but Rational?, *MIT Working Paper*, Massachusetts Institute of Technology, Cambridge, Massachusetts, USA.
- Dutta, D. (2000) Avswat- a Spatial Decision Support System for Land and Water Management and Its Application for Watershed Management in Bankura District of West Bengal, *Proceedings of the 3rd Annual International Conference Map India 2000*, New Delhi, India, 9-10 April 2000.

- Eckhardt, K., Breuer, L. and Frede, H.-G. (2003) Parameter Uncertainty and the Significance of Simulated Land Use Change Effects, *Journal of Hydrology*, Vol. 273, No. 1-4, pp. 164-176.
- Eiben, A.E. (1997) "Multi-Parent Recombination", in: *Handbook of Evolutionary Algorithms*, Bäck, T., Fogel, D. B. & Michalewicz, M. (eds.), IOP Publishing Ltd and Oxford University Press, pp. 25-33.
- Eiben, A.E. and Back, T. (1997) An Empirical Investigation of Multi-Parent Recombination Operators in Evolution Strategies, *Evolutionary Computation*, Vol. 5, No. 3, pp. 347-365.
- Eiben, A.E., Hinterding, R. and Michalewicz, Z. (1999) Parameter Control in Evolutionary Algorithms, *IEEE Transactions on Evolutionary Computation*, Vol. 3, No. 2, pp. 124-141.
- Eiben, A.E. and Schoenauer, M. (2002) Evolutionary Computing, *Information Processing Letters*, Vol. 82, pp. 1-6.
- Eiben, A.E. and Smith, J. (2003) *Introduction to Evolutionary Computing*, Springer, 299 pp.
- Eiben, A.E. and van Kemenade, C.H.M. (1995) Performance of Multi-Parent Crossover Operators on Numerical Function Optimization Problems, *TR95-33*, Leiden University (Department of Computer Science), Leiden, the Netherlands.
- Ekman, S. (2002) Modelling Agricultural Production Systems Using Mathematical Programming, *Doctor of Philosophy Thesis*, Swedish University of Agricultural Sciences, Acta Universitatis Agriculturae Sueciae, Uppsala, Sweden, 26 pp.
- Eshelman, L.J. and Schaffer, J.D. (1991) Preventing Premature Convergence in Genetic Algorithms by Preventing Incest, *Proceedings of the 4th International Conference on Genetic Algorithms (ICGA'91)*, University of California-San Diego, California, USA, July 1991, pp. 115-122.
- ESRI (1999) *Mapobjects - Window Edition 20*, [online]: <http://www.esri.com/>, accessed (21 August 2006).
- Falcão, A.O. and Borges, J.G. (2002) Combining Random and Systematic Search Heuristic Procedures for Solving Spatially Constrained Forest Management Scheduling Models, *Forest Ecology and Management*, Vol. 48, No. 3, pp. 608-621.
- Falcão, A.O. and Borges, J.G. (2001) Designing an Evolution Program for Solving Integer Forest Management Scheduling Models: An Application in Portugal, *Forest Science*, Vol. 47, No. 2, pp. 158-168.

- Fawcett, R.H., Nkowani, K. and Smith, C.J.N. (1997) Multiple Objective Socio-Economic Models of Agroforestry Systems, *Agroforestry Forum*, Vol. 8, No. 2, pp. 42-45.
- Fernandes, C., Tavares, R. and Rosa, A.C. (2000) Nigavaps—Outbreeding in Genetic Algorithms, *Proceedings of the 2000 ACM Symposium on Applied Computing*, Como, Milan, Italy, pp. 477–482.
- Fischer, G.W., Makowski, M. and Antoine, J. (1996) Multiple Criteria Land Use Analysis, *WP-96-006*, International Institute for Applied Systems Analysis, Laxenburg, Austria.
- Fisher, J. (2005) *Personal Communication*.
- Fisher, J., Asseng, S., Bowden, B. and Robertson, M.J. (2001a) Enhancing Recommendations of Flowering and Yield in Wheat, *Crop Updates 2001*, Department of Agriculture, Western Australia, Perth, Western Australia, Australia.
- Fisher, J., Asseng, S., Bowden, J.W. and Robertson, M.J. (2001b) Trial-Years without Tears: Enhancing Recommendations of Flowering and Yield in Wheat, *Proceedings of the 10th Australian Agronomy Conference*, Hobart, Australia, 29 January - 01 February 2001.
- Fisher, J., Bowden, B., Scanlan, C., Asseng, S. and Robertson, M.J. (2002) 101 Seasons in One Day: Using the 'WA Wheat' Database to Predict Wheat Yield, *Proceedings of 2002 Cereals Update - Western Australia*, Sheraton Hotel, Perth, Western Australia, Australia, 21-21 February 2002, pp. 21-22.
- Fogel, D.B. (2000) *What Is Evolutionary Computation?*, Spectrum, IEEE Press, No. February, pp. 26-32.
- Fogel, D.B. (1997) "The Advantages of Evolutionary Computation", in: *Bio-Computing and Emergent Computation (Bcec97)*, Sköve, Sweden, Lundh, D., Olsson, B. & Narayanan, A. (eds.), World Scientific Press, Singapore, pp. 1-11.
- Fogel, L.J., Owens, A.J. and Walsh, M.J. (1966) *Artificial Intelligence through Simulation Evolution*, John Wiley & Sons, New York, USA, 170 pp.
- Folino, G., Pizzuti, C., Spezzano, G., Vanneschi, L. and Tomassini, M. (2003) Diversity Analysis in Cellular and Multipopulation Genetic Programming, *Proceedings of the 5th Congress on Evolutionary Computation (CEC'2003)*, Canberra ACT, Australia, 8-12 December 2003.
- Fonseca, C.M. and Flichman, G. (2002) Dynamic Optimisation Problems: Different Resolution Methods Regarding Agriculture and Natural Resource Economics, *Working Paper*, Institut Agronomique Mediterranéen de Montpellier, France, Paris.

- Fonseca, C.M.M. (1995) Multiobjective Genetic Algorithms with Application to Control Engineering Problems, *Doctor of Philosophy Thesis*, Department of Automatic Control and Systems Engineering, University of Sheffield, Western Bank, Sheffield, UK, 172 pp.
- Fonseca, C.M.M. and Fleming, P.J. (1993) Genetic Algorithms for Multiobjective Optimization: Formulation, Discussion and Generalization, *Proceedings of the 5th International Conference on Genetic Algorithms (ICGA'93)*, Urbana-Champaign, Illinois, USA, June 1993, pp. 416-423.
- Fotheringham, A.S. and Rogerson, P. (1994) *Spatial Analysis and GIS*, Taylor & Francis, London, UK, 281 pp.
- Freedman, D. and Diaconis, P. (1981) On the Histogram as a Density Estimator:  $L_2$  Theory, *Zeitschrift für Wahrscheinlichkeitstheorie und verwandte Gebiete*, Vol. 57, No. 453-476
- Gali, V.J. and Brown, C.G. (2000) Assisting Decision-Making in Queensland Barley Production through Chance Constrained Programming, *The Australian Journal of Agricultural and Resource Economics*, Vol. 44, No. 2, pp. 269-287.
- Genome News Network (2003) *What's a Genome*, [online]: [http://www.genomenetwork.org/resources/whats\\_a\\_genome/Chp1\\_1\\_1.shtml#genome1](http://www.genomenetwork.org/resources/whats_a_genome/Chp1_1_1.shtml#genome1), accessed (29 June 2005).
- Glover, F. (1990) Tabu Search - Part II, *ORSA Journal on Computing*, Vol. 2, No. 1, pp. 4-32.
- Glover, F. (1989) Tabu Search - Part I, *ORSA Journal on Computing*, Vol. 1, No. 3, pp. 190-206.
- Gold, M.V. (1999) *Sustainable Agriculture: Definitions and Terms*, [online]: [http://www.nal.usda.gov/afsic/AFSIC\\_pubs/srb9902.htm](http://www.nal.usda.gov/afsic/AFSIC_pubs/srb9902.htm), accessed (31 May 2005).
- Goldberg, D.E. (1991) "A Comparative Analysis of Selection Schemes Used in Genetic Algorithms", in: *Foundations of Genetic Algorithm*, Rawlins, G. (ed.), Morgan Kaufmann, USA, pp. 69-93.
- Goldberg, D.E. (1989) *Genetic Algorithms in Search, Optimization, and Machine Learning*, Addison-Wesley, Reading, Massachusetts, USA.
- Goldberg, D.E., Korb, B. and Deb, K. (1989) Messy Genetic Algorithms: Motivations, Analysis and First Results, *Complex Systems*, Vol. 3, pp. 493-530.
- Goldberg, D.E. and Richardson, J. (1987) Genetic Algorithms with Sharing for Multimodal Function Optimization, *Proceedings of the 2nd International Conference on Genetic Algorithms (ICGA'87)*, Massachusetts Institute of Technology-Cambridge, Massachusetts, USA, pp. 41-49.

- Goodchild, M.F., Haining, R. and Wise, S. (1992) Integrating GIS and Spatial Data Analysis: Problems and Possibilities, *International Journal of Geographical Information Science*, Vol. 6, No. 5, pp. 407-424.
- Gordon, S.V. and Whitley, D. (1993) Serial and Parallel Genetic Algorithms as Function Optimizers, *Proceedings of the 5<sup>th</sup> International Conference on Genetic Algorithms (ICGA'93)*, Urbana-Champaign, Illinois, USA, June 1993, pp. 177-183.
- Grassini, L. and Viviani, A. (2005) A Multicriteria Decision Method to Evaluate Local Transport Service, *Proceedings of the XIth International Symposium on Applied Stochastic Models and Data Analysis (ASMDA 2005)*, 17-18 May 2005.
- Groover, G. and Roberts, M. (2000) Pulling It Together: Risk and Farm Business Management Planning, *Farm Financial Issues and Options*, No. 446-500W, Virginia Cooperative Extension, Virginia, USA.
- Guitouni, A. and Martel, J.M. (1998) Tentative Guidelines to Help Choosing an Appropriate MCDA Method, *European Journal of Operational Research*, Vol. 109, No. 2, pp. 501-521.
- Gupta, A.P., Harboe, R. and Tabucanon, M.T. (2000) Fuzzy Multiple-Criteria Decision Making for Crop Area Planning in Narmada River Basin, *Agricultural Systems*, Vol. 63, No. 1, pp. 1-18.
- Gustafson, S. (2004) An Analysis of Diversity in Genetic Programming, *Doctor of Philosophy Thesis*, School of Computer Science and Information Technology, University of Nottingham, Nottingham, UK, 158 pp.
- Hammer, G.L. and Muchow, R.C. (1994) Assessing Climatic Risk to Sorghum Production in Water-Limited Subtropical Environments I Development and Testing of a Simulation Model, *Field Crops Research*, Vol. 36, No. 3, pp. 221-234.
- Hanson, F.B. and Ryan, D. (1998) Optimal Harvesting with Both Population and Price Dynamics, *Mathematical Biosciences*, Vol. 148, No. 2, pp. 129-146.
- Hardaker, J.B., Huirne, R.B.M. and Anderson, J.R. (1997) *Coping with Risk in Agriculture*, CAB International, Wallingford, UK, 274 pp.
- Hardaker, J.B. and Lien, G. (2005) Towards Some Principles of Good Practice for Decision Analysis in Agriculture, *NILF-notat 2005-1*, Norsk institutt for landbruksøkonomisk forskning (NILF), Norwegian Agricultural Economics Research Institute, Norway.
- Hardaker, J.B., Pandey, S. and Patten, L.H. (1991) Farm Planning under Uncertainty: A Review of Alternative Programming Models, *Review of Marketing and Agricultural Economics*, Vol. 59, No. 1, pp. 9-22.

- Hayashi, K. (2000) Multicriteria Analysis for Agricultural Resource Management: A Critical Survey and Future Perspectives, *European Journal of Operational Research*, Vol. 122, No. 2, pp. 486-500.
- Hayman, P. (2004) Decision Support Systems in Australian Dryland Farming: A Promising Past, a Disappointing Present and Uncertain Future, *Proceedings of the 4th International Crop Science Congress (ICSC2004)*, Brisbane, Australia, 26 September-1 October 2004, p. 1778.
- Haynes, T. (1997) Collective Adaption: Explicit Cooperation in a Competitive Computational Agent Society, *Proposal Thesis*, Department of Mathematics and Computer Science, University of Tulsa, Tulsa, 60 pp.
- Hazell, P.B.R. (1971) A Linear Alternative to Quadratic and Semivariance Programming for Farm Planning under Uncertainty, *American Journal of Agricultural Economics*, Vol. 53, pp. 53-62.
- Hearn, A.B. and Da Rosa, D.A. (1985) A Simple Model for Crop Management Applications for Cotton, *Field Crops Research*, Vol. 12, No. 1, pp. 46-69.
- Herrera, F. and Lozano, M. (1996) "Adaptation of Genetic Algorithm Parameters Based on Fuzzy Logic Controllers", in: *Genetic Algorithms and Soft Computing*, Herrera, F. & Verdegay, J. L. (eds.), Physica-Verlag, pp. 95-125.
- Hess, U., Skees, J., Barnett, B., Stoppa, A. and Nash, J. (2005) Managing Agricultural Production Risk: Innovations in Developing Countries, *32727-GLB*, The International Bank for Reconstruction and Development / The World Bank, Washington, DC, USA.
- Hillier, F.S. and Lieberman, G.J. (2001) *Introduction to Operations Research*, McGraw-Hill, Boston, Massachusetts, USA, 1214 pp.
- Ho, W.H. and Lee, G.W. (2000) Study on Land Use Management with Geographic Information Systems, *Proceedings of the 21<sup>st</sup> Asian Conference on Remote Sensing (ACRS'2000)*, Taipei, Taiwan, 4-8 December 2000.
- Hokkanen, J. and Salminen, P. (1997) ELECTRE III and IV Methods in an Environmental Problem, *Journal of Multi-Criteria Decision Analysis*, Vol. 6, pp. 215-226.
- Holland, J.H. (1975) *Adaptation in Natural and Artificial Systems : An Introductory Analysis with Applications to Biology, Control, and Artificial Intelligence*, University of Michigan, Michigan, USA, 183 pp.
- Holland, J.H., Holyoak, K.J., Nisbett, R.E. and Thagard, P.R. (1986) *Induction: Processes of Inference, Learning and Discovery*, MIT Press, Cambridge, Massachusetts, USA.

- Holsheimer, M. and Siebes, A. (1994) Data Mining: The Search for Knowledge in Databases, *Technical Report CS-R9406*, CWI, Amsterdam, the Netherlands.
- Holton, G.A. (2004) Perspectives: Defining Risk, *Financial Analysts Journal*, Vol. 60, No. 6, pp. 19-25.
- Hoppe, A., Lang, S., Lerch, C. and Marinoni, O. (2005) Towards More Sustainability in Land Use Decisions: Development of a Geology Focused Spatial Decision Support System for the Periphery of Metropolitan Areas, *Proceedings of the ICID 21th European Regional Conference (ERC'2005)*, Frankfurt (Oder) and Slubice - Germany and Poland, 15-19 May 2005.
- Horn, J. and Nafpliotis, N. (1993) Multiobjective Optimization Using the Niche Pareto Genetic Algorithm, *Technical Report IlliGAL 93005*, University of Illinois at Urbana-Champaign (Department of General Engineering), Urbana-Champaign, Illinois, USA.
- Horn, J., Nafpliotis, N. and Goldberg, D.E. (1994) A Niche Pareto Genetic Algorithm for Multiobjective Optimization, *Proceedings of the 1st IEEE International Conference on Evolutionary Computation (IEEE/ICEC'94)*, *IEEE World Congress on Computational Intelligence (WCCI'94)*, Orlando, Florida, USA, 27-29 June 1994, pp. 82-87.
- Huang, W., Luukkanen, O., Johanson, S., Kaarakka, V., Räsänen, S. and Vihemäki, H. (2002) Agroforestry for Biodiversity Conservation of Nature Reserves: Functional Group Identification and Analysis, *Agroforestry Systems*, Vol. 55, No. 1
- Huth, N.I., Snow, V.O. and Keating, B.A. (2001) Integrating a Forest Modelling Capability into an Agric Production Forest Modelling Capability into an Agric Production Future Possibilities, *Proceedings of International Congress on Modelling and Simulation (MODSIM 2001)*, Australian National University (ANU), Canberra ACT, Australia, pp. 1895-1900.
- Hwang, C.L., Lai, Y.J. and Ko, M.D. (1993) Isgp-II for Multiobjective Optimization with Imprecise Objective Coefficients, *Computers and Operations Research*, Vol. 20, No. 5, pp. 503-514.
- Hwang, C.L., Paidy, S.R., Yoon, K. and Masud, A.S.M. (1980) Mathematical Programming with Multiple Objectives: A Tutorial, *Computers and Operations Research*, Vol. 7, No. 1-2, pp. 5-31.
- Hwang, C.L. and Yoon, K.L. (1981) *Multiple Attribute Decision Making: Methods and Applications: A State of the Art Survey*, Springer-Verlag, Berlin, Germany.
- Ignizio, J.P. (1985) *Introduction to Linear Goal Programming*, Sage University Papers, Beverly Hills, California, USA.

- Ignizio, J.P. and Cavalier, T.M. (1994) *Linear Programming*, Prentice Hall, New Jersey, USA.
- Janke, R.R. (2000) Whole-Farm Planning for Economic and Environmental Sustainability, *MF-2403*, Kansas State University Agricultural Experiment Station and Cooperative Extension Service, Kansas State University, Kansas, Manhattan, USA.
- Janke, R.R. and Freyenberger, S.G. (1997) Indicators of Sustainability in Whole Farm Planning: Planning Tools, *Kansas Sustainable Agriculture Series, Paper # 3 (98-124-D)*, Kansas Center for Sustainable Agriculture and Alternative Crops (KCSAAC), Kansas, Manhattan, USA.
- Jaszkiewicz, A. (2001) Multiple Objective Metaheuristic Algorithms for Combinatorial Optimization, *Doctor of Philosophy Thesis*, Poznan University of Technology, Poznan, Poland, 148 pp.
- Jensen, M.T. (2001) Robust and Flexible Scheduling with Evolutionary Computation, *Doctor of Philosophy Thesis*, Department of Computer Science, University of Aarhus, Denmark, 299 pp.
- Joerger, P. (1999) *The Future of Farming and Ranching: Creating a Vision & Mission & Setting Goals*, Ag News & Views, No. December 1999.
- Joerin, F., Theriault, M. and Musy, A. (2001) Using GIS and Outranking Multicriteria Analysis for Land-Use Suitability Assessment, *International Journal of Geographical Information Science*, Vol. 15, No. 2, pp. 153-174.
- Jolliet, O., Margni, M., Charles, R., Humbert, S., Payet, J., Rebitzer, G. and Rosenbaum, R. (2003) Impact 2002+: A New Life Cycle Impact Assessment Methodology, *International Journal of Life Cycle Assessment*, Vol. 8, No. 6, pp. 324-330.
- Jones, D. and Barnes, E.M. (2000) Fuzzy Composite Programming to Combine Remote Sensing and Crop Models for Decision Support in Precision Crop Management, *Agricultural Systems*, Vol. 65, No. 3, pp. 137-158.
- Jones, R.D. and Fogleman, S.L. (2005) Farm and Ranch Strategic Planning (Visioning and Goal Setting), *MF-2695*, Kansas State University Agricultural Experiment Station and Cooperative Extension Service, Kansas State University, Kansas, Manhattan, USA.
- Jorgensen, E. (2001) *Model-Based Decision Support Systems in Agriculture*, [online]: <http://www.jbs.agrsci.dk/~ejo/models.html>, accessed (29 April 2003).
- Julstrom, B.A. (1997) Adaptive Operator Probabilities in a Genetic Algorithm That Applies Three Operators, *Proceedings of the 1997 ACM Symposium on Applied Computing*, Hyatt Sainte Claire Hotel-San Jose, California, USA, pp. 233-238.



- Just, D.R., Wolf, S. and Zilberman, D. (2003) Principles of Risk Management Service Relations in Agriculture, *Agricultural Systems*, Vol. 75, No. 2-3, pp. 199-213.
- Just, R.E. (2003) Risk Research in Agricultural Economics: Opportunities and Challenges for the Next Twenty-Five Years, *Agricultural Systems*, Vol. 75, No. 2-3, pp. 123-159.
- Kandaswamy, S. (2001) The Basics of Monte Carlo Simulation: A Tutorial, *Proceedings of the Project Management Institute Annual Seminars & Symposium*, Nashville, Tennessee, USA, 1-10 November 2001.
- Kangas, A.S., Kangas, J. and Pykalainen, J. (2001a) Outranking Methods as Tools in Strategic Natural Resources Planning, *Silva Fennica*, Vol. 35, No. 2, pp. 215-227.
- Kangas, J. and Kangas, A.S. (2005) Multiple Criteria Decision Support in Forest Management-the Approach, Methods Applied, and Experiences Gained, *Forest Ecology and Management*, Vol. 207, No. 1-2, pp. 133-143.
- Kangas, J., Kangas, A.S., Leskinen, P. and Pykalainen, J. (2001b) MCDM Methods in Strategic Planning of Forestry on State-Owned Lands in Finland: Applications and Experiences, *Journal of Multi-Criteria Decision Analysis*, Vol. 10, No. 5, September/October 2001, pp. 257-271.
- Kangas, J. and Pukkala, T. (1992) A Decision Theoretic Approach Applied to Goal Programming of Forest Management, *Silva Fennica*, Vol. 26, No. 1, pp. 51-58.
- Kantor, S. (1999) Moving toward Sustainable Farming Practices, *Agriculture and Natural Resources Fact Sheet #533*, Washington State University, Washington, DC, USA.
- Karni, E. (2005) Foundations of Bayesian Theory, *Working Papers No.524*, The John Hopkins University (Department of Economics), Baltimore, UK.
- Keating, B.A., Carberry, P.S., Hammer, G.L., Probert, M.E., Robertson, M.J., Holzworth, D., Huth, N.I., Hargreaves, J.N.G., Meinke, H. and Hochman, Z. (2003) An Overview of Apsim, a Model Designed for Farming Systems Simulation, *European Journal of Agronomy*, Vol. 18, No. 3-4, pp. 267-288.
- Keating, B.A., Meinke, H., Probert, M.E., Huth, N.I. and Hills, I.G. (2001) Nwheat: Documentation and Performance of a Wheat Module for Apsim, *Tropical Agriculture Technical Memorandum*, Vol. 9, No. 6
- Keating, B.A., Robertson, M.J., Muchow, R.C. and Huth, N.I. (1999) Modelling Sugarcane Production Systems I Development and Performance of the Sugarcane Module, *Field Crops Research*, Vol. 61, No. 3, pp. 253-271.

- Kemp, L. (1996) Successful Whole Farm Planning: Essential Elements Recommended by the Great Lakes Basin Farm Planning Network, The Minnesota Project, St. Paul, Minnesota, USA.
- Khalil, W.A.-S., Goonetilleke, A., Kokot, S. and Carroll, S. (2004) Use of Chemometrics Methods and Multicriteria Decision-Making for Site Selection for Sustainable on-Site Sewage Effluent Disposal, *Analytica Chimica Acta*, Vol. 506, No. 1, pp. 41-56.
- Kim, J.K. and Choi, S.H. (2001) A Utility Range-Based Interactive Group Support System for Multiattribute Decision Making, *Computers and Operations Research*, Vol. 28, No. 5, pp. 485-503.
- Kingwell, R.S. and Pannell, D.J. (1987) *Midas, a Bio-Economic Model of a Dryland Farm System*, PUDOC Wageningen, the Netherlands, 207 pp.
- Kingwell, R.S., Pannell, D.J. and Robinson, S.D. (1993) Tactical Responses to Seasonal Conditions in Whole-Farm Planning in Western Australia, *Agricultural Economics*, Vol. 8, No. 3, pp. 211-226.
- Kirkpatrick, S., Gelatt, C.D. and Vecchi, M.P. (1983) Optimization by Simulated Annealing, *Science*, Vol. 220, No. 4598, May, pp. 671-680.
- Klauer, B. and Brown, J.D. (2004) Conceptualising Imperfect Knowledge in Public Decision Making: Ignorance, Uncertainty, Error and Risk Situations, *Environmental Research, Engineering and Management*, Vol. 27, No. 1, pp. 124-128.
- Klauer, B., Drechsler, M. and Messner, F. (2002) Multicriteria Analysis under Uncertainty with Ianus - Method and Empirical Results, *UFZ-discussion papers 2002-02*, Departments of Economics, Sociology and Law (OEKUS) and Ecological Modelling, UFZ Centre for Environmental Research, Leipzig, Germany, pp. 1-32.
- Klauer, B., Messner, F. and Herzog, F. (2000) Evaluating Land-Use Management Strategies-an Integrated Ecological-Economic Decision-Making Approach Transitions Towards a Sustainable Europe: Ecology, Economy, Policy, *Proceedings of the 3rd Biennial Conference of the European Society for Ecological Economics*, Vienna, 3-6 May 2000.
- Knight, F.H. (1921) *Risk, Uncertainty and Profit*, Hart, Schaffner & Marx; Houghton Mifflin Company, Boston, Massachusetts, USA, 381 pp.
- Knowles, J.D. (2002) Local-Search and Hybrid Evolutionary Algorithms for Pareto Optimization, *Doctor of Philosophy Thesis*, Department of Computer Science, University of Reading, Reading, UK, 335 pp.
- Köksalan, M. and Ulu, C. (2003) An Interactive Approach for Placing Alternatives in Preference Classes, *European Journal of Operational Research*, Vol. 144, No. 2, pp. 429-439.

- Koza, J.R. (1997) "Genetic Programming", in: *Encyclopedia of Computer Science and Technology*, Vol. 39, Williams, J. G. & Kent, A. (eds.), Marcel Dekker, pp. 29-43.
- Kumar, R. and Rockett, P. (2002) Improved Sampling of the Pareto-Front in Multiobjective Genetic Optimization by Steady-State Evolution: A Pareto Converging Genetic Algorithm, *Evolutionary Computation*, Vol. 10, No. 3, pp. 283-314.
- Kurtener, D. and Badenko, V. (2000) A GIS Methodological Framework Based on Fuzzy Sets Theory for Land Use Management, *Journal of the Brazilian Computer Society*, Vol. 6, No. 3, pp. 26-32.
- Lau, H.C., Ng, K.M. and Wu, X.W. (2004) Transport Logistics Planning with Service-Level Constraints, *Proceedings of the 19th National Conference on Artificial Intelligence and the 16th Conference on Innovative Applications of Artificial Intelligence*, San Jose, California, USA, pp. 519-524.
- Laughlin, G. and Clark, A. (2000) Drought Science and Drought Policy in Australia: A Risk Management Perspective, *Proceedings of an Expert Group Meeting*, Lisbon, Portugal., 5-7 September 2000, pp. 32-44.
- Laumanns, M. (2003) Analysis and Applications of Evolutionary Multiobjective Optimization Algorithms, *Doctor of Science Thesis*, Computer Engineering and Networks Laboratory, Swiss Federal Institute of Technology, Zurich, Switzerland, 114 pp.
- Leach, P. (2005) *Late and over Budget: Why Projects Always Seem to Take Longer and Cost More Than Planned*, Tomorrow's Forecast: The online Newsletter for Risk Analysis and Spreadsheet Forecasting, 11 February 2005.
- Lee, C.H., Park, S.H. and Kim, J.H. (2000) Topology and Migration Policy of Fine-Grained Parallel Evolutionary Algorithms for Numerical Optimization, *Proceedings of the 2nd Congress on Evolutionary Computation (CEC'2000)*, San Diego, California, USA, 16-19 July 2000, pp. 70-76.
- Lerch, C., Marinoni, O., Lang, S. and Hoppe, A. (2003) Geology and Land Use: Sustainability in the Surroundings of Urban Areas (Southern Hesse, Germany), *Proceedings of the 4th European Congress on Regional Geoscientific Cartography and Information Systems*, Bologna, 17-20 June 2003, pp. 108-109.
- Levy, J.K., Hipel, K.W. and Kilgour, D.M. (2000) Using Environmental Indicators to Quantify the Robustness of Policy Alternatives to Uncertainty, *Ecological Modelling*, Vol. 130, No. 1-3, pp. 79-86.
- Lewontin, R.C. (1992) "Genotype and Phenotype", in: *Keywords in Evolutionary Biology*, Keller, E. R. & Lloyd, E. (eds.), Harvard University Press, Cambridge, Massachusetts, USA.

- Lieberman, G.J. (2005) *Avoiding Decision Traps*, [online]: <http://www.decisionstrategies.com/documents/AvoidingDecisionTraps.pdf>, accessed (15 June 2005).
- Lilburne, L. (1996) The Integration Challenge, *Proceedings of the 8th Colloquium of the Spatial Information Research Centre*, University of Otago, New Zealand, 9-11 July 1996.
- Linkov, I., Varghese, A., Jamil, S., Seager, T.P., Kiker, G.A. and Bridges, T.S. (2004) "Multi-Criteria Decision Analysis: A Framework for Structuring Remedial Decision at Contaminated Sites", in: *Comparative Risk Assessment and Environmental Decision Making* Vol. 38, Linkov, I. & Ramadan, A. B. (eds.), Kluwer, Rome(Anzio), Italy, pp. 15-54.
- Lisson, S.N., Mendham, N.J. and Carberry, P.S. (2000a) Development of a Hemp (Cannabis Sativa L) Simulation Model: I General Introduction and the Effect of Temperature on the Pre-Emergent Development of Hemp, *Australian Journal of Experimental Agriculture*, Vol. 40, No. 3, pp. 405-411.
- Lisson, S.N., Mendham, N.J. and Carberry, P.S. (2000b) Development of a Hemp (Cannabis Sativa L) Simulation Model: II the Flowering Response of Two Hemp Cultivars to Photoperiod, *Australian Journal of Experimental Agriculture*, Vol. 40, No. 3, pp. 413-417.
- Lisson, S.N., Mendham, N.J. and Carberry, P.S. (2000c) Development of a Hemp (Cannabis Sativa L) Simulation Model: III the Effect of Plant Density on Leaf Appearance, Expansion and Senescence, *Australian Journal of Experimental Agriculture*, Vol. 40, No. 3, pp. 419-423.
- Lisson, S.N., Mendham, N.J. and Carberry, P.S. (2000d) Development of a Hemp (Cannabis Sativa L) Simulation Model: IV Model Description and Validation, *Australian Journal of Experimental Agriculture*, Vol. 40, No. 3, pp. 425-432.
- Lisson, S.N., Robertson, M.J., Keating, B.A. and Muchow, R.C. (2000e) Modelling Sugarcane Production Systems II Analysis of System Performance and Methodology Issues, *Field Crops Research*, Vol. 68, No. 1, pp. 31-48.
- Luce, R.D. (1992) Where Does Subjective Expected Utility Fail Descriptively?, *Journal of Risk and Uncertainty*, Vol. 5, No. 1, pp. 5-27.
- Luke, S., Hamahashi, S. and Kitano, H. (1999) "Genetic" Programming, *Proceedings of the 1st Genetic and Evolutionary Computation Conference (GECCO'1999)*, Orlando, Florida, USA, 13-17 July 1999.
- Luke, S. and Spector, L. (1998) A Revised Comparison of Crossover and Mutation in Genetic Programming, *Proceedings of the 3rd Annual Conference on Genetic Programming (GP-98)*, University of Wisconsin-Madison, Wisconsin, USA, 22-25 July 1998, pp. 208-213.

- Maatman, A., Schweigman, C., Ruijs, A. and van der Vlerk, M.H. (2002) Modeling Farmers' Response to Uncertain Rainfall in Burkina Faso: A Stochastic Programming Approach, *Operations Research*, Vol. 50, No. 3, pp. 399-414.
- Mahfoud, S.W. (1995) Niching Methods for Genetic Algorithms, *Doctor of Philosophy Thesis*, Department of Computer Science, University of Illinois at Urbana-Champaign, Urbana, Illinois, USA, 251 pp.
- Mahfoud, S.W. (1992) Crowding and Preselection Revisited, *Proceedings of the 2nd International Conference on Parallel Problem Solving from Nature (PPSN II)*, Brussels, Belgium, 28-30 September 1992, pp. 27-36.
- Mahner, M. and Kary, M. (1997) What Exactly Are Genomes, Genotypes and Phenotypes and What About Phenomes?, *Journal of Theoretical Biology*, Vol. 186, No. 1, pp. 55-63.
- Malczewski, J. (1999) *GIS and Multicriteria Decision Analysis*, John Wiley & Sons, New York, USA.
- Malczewski, J., Moreno-Sanchez, R., BojÓrquez-Tapia, L.A. and Ongay-Delhumeau, E. (1997) Multicriteria Group Decision-Making Model for Environmental Conflict Analysis in the Cape Region, Mexico, *Journal of Environmental Planning and Management*, Vol. 40, No. 3, pp. 349-374.
- Maleka, P. (1993) An Application of Target Motad Model to Crop Production in Zambia: Gwembe Valley as a Case Study, *Agricultural Economics*, Vol. 9, No. 1, pp. 15-35.
- Manderick, B. and Spiessens, P. (1989) Fine-Grained Parallel Genetic Algorithms, *Proceedings of the 3rd International Conference on Genetic Algorithms (ICGA'89)*, George Mason University-Fairfax, Virginia, United States, June 1989, pp. 428-433.
- Mansouri, S.A., Moattar Hussein, S.M. and Newman, S.T. (2000) A Review of the Modern Approaches to Multi-Criteria Cell Design, *International Journal of Production Research*, Vol. 38, No. 5, pp. 1201-1218.
- Marler, R.T. and Arora, J.S. (2004) Survey of Multi-Objective Optimization Methods for Engineering, *Structural and Multidisciplinary Optimization*, Vol. 26, pp. 369-395.
- Mateu, A.V. (2002) Clusdm: A Multiple Criteria Decision Making Method for Heterogeneous Data Sets, *Doctor of Philosophy Thesis*, Departament de Llenguatges i Sistemes Informàtics, Universitat Politècnica de Catalunya, Tarragona, Spain, 179 pp.
- Matthews, K.B. (2001) Applying Genetic Algorithms to Multi-Objective Land-Use Planning, *Doctor of Philosophy Thesis*, The Robert Gordon University, Craigiebuckler, Aberdeen, UK, 156 pp.

- Matthews, K.B., Buchan, K., Sibbald, A.R. and Craw, S. (2004) Combining Deliberative and Computer-Based Methods for Multi-Objective Land-Use Planning, *Agricultural Systems*
- Mayer, D.G., Belward, J.A. and Burrage, K. (2001) Robust Parameter Settings of Evolutionary Algorithms for the Optimisation of Agricultural Systems Models, *Agricultural Systems*, Vol. 69, No. 3, pp. 199-213.
- Mayer, D.G., Belward, J.A. and Burrage, K. (1999) Performance of Genetic Algorithms and Simulated Annealing in the Economic Optimization of a Herd Dynamics Model, *Environment International*, Vol. 25, No. 6-7 SU -, pp. 899-905.
- Mayer, D.G., Belward, J.A. and Burrage, K. (1998a) Optimizing Simulation Models of Agricultural Systems, *Annals of Operations Research*, Vol. 82, No. 0, pp. 219-232.
- Mayer, D.G., Belward, J.A. and Burrage, K. (1998b) Tabu Search Not an Optimal Choice for Models of Agricultural Systems, *Agricultural Systems*, Vol. 58, No. 2, pp. 243-251.
- Mayer, D.G., Kinghorn, B.P. and Archer, A.A. (2005) Differential Evolution - an Easy and Efficient Evolutionary Algorithm for Model Optimisation, *Agricultural Systems*, Vol. 83, No. 3, pp. 315-328.
- McConnell, D.J. and Dillon, J.L. (1997) Farm Management for Asia: A Systems Approach, *FAO Farm Systems Management Series 13*, Food and Agriculture Organization of the United Nations, Rome, Italy.
- McGregor, M.J., Rola-Rubzen, M.F. and Murray-Prior, R. (2001) Micro and Macro-Level Approaches to Modelling Decision Making, *Agricultural Systems*, Vol. 69, No. 1-2, pp. 63-83.
- McKay, M.D., Conover, W.J. and Beckman, R.J. (1979) A Comparison of Three Methods for Selecting Values of Input Variables in the Analysis of Output from a Computer Code, *Technometrics*, Vol. 21, pp. 239-245.
- McMaster, L.C. and McMaster, J.S. (2002) Developing an Environmental Management Systems Framework for Processing Tomatoes Literature Review of Sustainable Agriculture to June 2001: Part a-Theoretical Considerations, *Proceedings of the VIII International Symposium on the Processing Tomato*, Istanbul, Turkey.
- Meinke, H., Hammer, G.L. and Chapman, S.C. (1993) A Sunflower Simulation Model: II Simulating Production Risks in a Variable Sub-Tropical Environment, *Agronomy Journal*, Vol. 85, pp. 735-742.
- Meinke, H., Hammer, G.L., van Keulen, H. and Rabbinge, R. (1998a) Improving Wheat Simulation Capabilities in Australia from a Cropping System

- Perspective II: Testing Simulation Capabilities of Wheat Growth, *European Journal of Agronomy*, Vol. 8, No. 1, pp. 83-99.
- Meinke, H., Hammer, G.L., van Keulen, H. and Rabbinge, R. (1998b) Improving Wheat Simulation Capabilities in Australia from a Cropping System Perspective III: The Integrated Wheat Model (I\_Wheat), *European Journal of Agronomy*, Vol. 8, No. 1, pp. 101-116.
- Mendola, M. (2005) Farm Households Production Theories: A Review of 'Institutional' and 'Behavioural' Responses, *Working Paper No. 1*, Dipartimento di Economia Politica e Aziendale, Università degli Studi di Milano, Milano, Italy.
- Mendoza, G.A., Anderson, A.B. and Gertner, G.Z. (2002a) Integrating Multi-Criteria Analysis and GIS for Land Condition Assessment: Part I – Evaluation and Restoration of Military Training Areas, *Journal of Geographic Information and Decision Analysis*, Vol. 6, No. 1, pp. 1-16.
- Mendoza, G.A., Anderson, A.B. and Gertner, G.Z. (2002b) Integrating Multi-Criteria Analysis and GIS for Land Condition Assessment: Part II – Allocation of Military Training Areas, *Journal of Geographic Information and Decision Analysis*, Vol. 6, No. 1, pp. 17-30.
- Mendoza, G.A. and Prabhu, R. (2000a) Development of a Methodology for Selecting Criteria and Indicators of Sustainable Forest Management: A Case Study on Participatory Assessment, *Environmental Management*, Vol. 26, No. 6, pp. 659-673.
- Mendoza, G.A. and Prabhu, R. (2000b) Multiple Criteria Decision Making Approaches to Assessing Forest Sustainability Using Criteria and Indicators: A Case Study, *Forest Ecology and Management*, Vol. 131, No. 1-3, pp. 107-126.
- Mengshoel, O.J. and Goldberg, D.E. (1999) Probabilistic Crowding: Deterministic Crowding with Probabilistic Replacement, *Technical Report IlliGAL 99004*, Department of Computer Science, University of Illinois at Urbana-Champaign, Urbana, Illinois, USA, pp. 1-13.
- Metropolis, N., Rosenbluth, A., Rosenbluth, M., Teller, A. and Teller, E. (1953) Equation of State Calculation by Fast Computing Machines, *Journal of Chemical Physics*, Vol. 21, pp. 1087-1092.
- Metternicht, G.I. (1999) Change Detection Assessment Using Fuzzy Sets and Remotely Sensed Data: An Application of Topographic Map Revision, *ISPRS Journal of Photogrammetry and Remote Sensing*, Vol. 54, No. 4, pp. 221-233.
- MIA (2001) *The Muresk Farm*, [online]: <http://www.curtin.edu.au/curtin/muresk/about2.htm>, accessed (07 April 2003).

- Michalewicz, Z. (1996) *Genetic Algorithms + Data Structures = Evolution Programs*, (3<sup>rd</sup> edn), Springer-Verlag, Berlin, Germany.
- Michalewicz, Z., Xiao, J. and Trojanowski, K. (1996) Evolutionary Computation: One Project, Many Directions, *Proceedings of the International Symposium on Methodologies for Intelligent Systems*, pp. 189-201.
- Microsoft (2003) *Microsoft*, [online]: <http://www.microsoft.com/>, accessed (21 May 2003).
- Miettinen, K. (2001) Some Methods for Nonlinear Multi-Objective Optimization, *Proceedings of the 1st International Conference on Evolutionary Multi-Criterion Optimization (EMO 2001)*, Zurich, Switzerland, 7-9 March 2001, pp. 1-20.
- Miller, B.L. and Goldberg, D.E. (1995) Genetic Algorithms, Tournament Selection, and the Effects of Noise, *Technical Report IlliGAL 95006*, Department of General Engineering, University of Illinois at Urbana-Champaign, Urbana-Champaign, Illinois, USA.
- Moran, L. (1993a) *Random Genetic Drift*, [online]: <http://www.talkorigins.org/faqs/genetic-drift.html>, accessed (24 July 2005).
- Moran, L. (1993b) *What Is Evolution?*, [online]: <http://www.talkorigins.org/faqs/evolution-definition.html>, accessed (24 July 2005).
- Moreddu, C. (2000) Overview of Farm Household Strategies and Government Intervention, *Proceedings of the Organisation for Economic Co-operation and Development (OECD) Workshop on Income risk management in agriculture*, Paris, France, 15-16 May 2000, pp. 17-61.
- Moscato, P. and Cotta, A. (1999) "A Gentle Introduction to Memetic Algorithms", in: *Handbook of Metaheuristics*, Glower, F. & Kochenberger, G. (eds.), Kluwer, pp. 1-56.
- Muchow, R.C., Hammer, G.L. and Vanderlip, R.L. (1994) Assessing Climatic Risk to Sorghum Production in Water-Limited Subtropical Environments II Effects of Planting Date, Soil Water at Planting, and Cultivar Phenology, *Field Crops Research*, Vol. 36, No. 3, pp. 235-246.
- Munn, R.E. (ed.) (1979) *Environmental Impact Assessment*, UNEP, Environment Canada and UNESCO, Toronto, Ontario.
- Muttiah, R., Srinivasan, R. and Engel, B. (1996) Development and Application of Neural Network Interface for Grass GIS, *Proceedings of the Third International Conference/Workshop on Integrating GIS and Environmental Modeling*, Santa Fe, NM, USA 21 - 26 January 1996.



- Narayanaswamy, V., Altham, W.A., van Berkel, R. and McGregor, M.J. (2004) Environmental Life Cycle Assessment (LCA) Case Studies for Western Australian Grains Products, *Report on the project funded by the GRDC covering wheat-to-bread, barley-to-beer and canola-to-cooking oil value chains*, Curtin University of Technology, Perth, Western Australia, Australia.
- Narayanaswamy, V., Altham, W.A., van Berkel, R. and McGregor, M.J. (2003) Methodological Framework for Application of Environmental Life Cycle Assessment (LCA) to Australian Grains, *Report on the project funded by the GRDC covering wheat-to-bread, barley-to-beer and canola-to-cooking oil value chains*, Curtin University of Technology, Perth, Western Australia, Australia.
- Narayanaswamy, V., van Berkel, R., Altham, W.A. and McGregor, M.J. (2005) Application of Life Cycle Assessment to Enhance Eco-Efficiency of Grains Supply Chains, *Proceedings of the 4th ALCAS Conference*, Sydney, New South Wales, Australia.
- National Center for Biotechnology Information (2004) *A Basic Introduction to the Science Underlying NCBI Resources: What Is a Genome?*, [online]: [http://www.ncbi.nlm.nih.gov/About/primer/genetics\\_genome.html](http://www.ncbi.nlm.nih.gov/About/primer/genetics_genome.html), accessed (29 June 2005).
- Nau, R.F. (2006) "Extensions of the Subjective Expected Utility Model", in: *Advances in Decision Analysis: From Foundations to Applications*, Edwards, W., Miles, R. J. & von Winterfeldt, D. (eds.), Cambridge University Press.
- NeuroDimension (2002) *What Are Genetic Algorithms?*, [online]: <http://www.nd.com/genetic/whatisga.html>, accessed (25 June 2003).
- Nievergelt, J. (2000) Exhaustive Search, Combinatorial Optimization and Enumeration: Exploring the Potential of Raw Computing Power, *Proceedings of the 27th Conference on Current Trends in Theory and Practice of Informatics (SOFSEM'2000)*, Milovy, Czech Republic, 25 November - 2 December 2000, pp. 18-35.
- Nievergelt, J., Gasser, R.U., Maser, F. and Wirth, C. (1995) "All the Needles in a Haystack: Can Exhaustive Search Overcome Combinatorial Chaos?", in: *Computer Science Today, Lecture Notes in Computer Science 1000*, van Leeuwen, J. (ed.), Springer-Verlag, Berlin, Germany, pp. 254-274.
- Nigel, G. (2002) Complexity and Heuristics in Rule-Based Algorithmic Music Composition, *Doctor of Philosophy Thesis*, The Department of Computer Science, Louisiana State University and Agricultural and Mechanical College, Louisiana, USA, 199 pp.
- O'Brien, R.A. (2004) Spatial Decision Support for Selecting Tropical Crops and Forages in Uncertain Environments, *Doctor of Philosophy Thesis*, Spatial Science Department, Curtin University of Technology, Perth, Western Australia, Australia, 278 pp.

- Odum, E.P. (1971) *Fundamentals of Ecology*, (3rd edn), Saunders, Philadelphia, USA, 574 pp.
- Ogryczak, W. and Ruszczyński, A. (1997) From Stochastic Dominance to Mean–Risk Models: Semideviations as Risk Measures, *Interim Report IR-97-027*, International Institute for Applied Systems Analysis, Laxenburg, Austria.
- Ohman, K. and Eriksson, L.O. (2002) Allowing for Spatial Consideration in Long-Term Forest Planning by Linking Linear Programming with Simulated Annealing, *Forest Ecology and Management*, Vol. 161, No. 1-3, pp. 221-230.
- Ohman, K. and Eriksson, L.O. (1998) The Core Area Concept in Forming Contiguous Areas for Long-Term Forest Planning, *Canadian Journal of Forest Research*, Vol. 28, No. 7, pp. 1032-1037.
- Oliver, R.M. and Smith, J.Q. (1990) *Influence Diagrams, Belief Nets and Decision Analysis*, John Wiley & Sons, Chichester, UK.
- OMAFRA (2002) Agronomy Guide for Field Crops - Publication 811, Land Use Planning Program, Ontario Ministry of Agriculture, Food And Rural Affairs, Ontario, Ottawa, Canada, pp. 1-36.
- Palisade Corporation (2000) *Guide to Using @Risk, Risk Analysis and Simulation Add-in for Microsoft® Excel, Version 4*, Palisade Corporation,, Newfield, New York, USA, 474 pp.
- Pan, J. (1999) Madm Framework for Strategic Resource Planning of Electric Utilities, *Doctor of Philosophy Thesis*, Electrical and Computer Engineering, Faculty of the Virginia Polytechnic Institute and State University, Blacksburg, Virginia, USA, 124 pp.
- Pan, J., Teklu, Y. and Rahman, S. (2000) An Interval-Based Madm Approach to the Identification of Candidate Alternatives in Strategic Resource Planning, *IEEE Transactions on Power Systems*, Vol. 15, No. 4, pp. 1441-1446.
- Pannell, D.J. (1997) Sensitivity Analysis of Normative Economic Models: Theoretical Framework and Practical Strategies, *Agricultural Economics*, Vol. 16, pp. 139-152.
- Pannell, D.J. (1995) Economic Aspects of Legume Management and Legume Research in Dryland Farming Systems of Southern Australia, *Agricultural Systems*, Vol. 49, No. 2-3, pp. 110-129.
- Pannell, D.J., Malcolm, B. and Kingwell, R.S. (2000) Are We Risking Too Much? Perspectives on Risk in Farm Modelling, *Agricultural Economics*, Vol. 23, No. 1, pp. 69-78.

- Pannell, D.J. and Nordblom, T.L. (1998) Impact of Risk Aversion on Whole-Farm Management in Syria, *The Australian Journal of Agricultural and Resource Economics*, Vol. 42, No. 3, pp. 227-247.
- Pareto, V. (1971) *Manual of Political Economy*, Augustus M. Kelley, New York, USA, 504 pp.
- Parsons, J. (2002) Agland Decision Tool: A Multicriteria Decision Support System for Agricultural Property, *Proceedings of the 1st Biennial Meeting of the International Environmental Modelling and Software Society (iEMSs'2002): Integrated Assessment and Decision Support*, Lugano, Switzerland, 24-27 June 2002, pp. 181-186.
- Patterson, P.E., Gray, C.W. and Rimbey, N.R. (2005) 2005-06 Long Range Planning Prices for Idaho Crops & Livestock, *Departmental Working Paper Series - A. E. Extension Series No. 05-05*, Department of Agricultural Economics and Rural Sociology, College of Agricultural and Life Sciences, University of Idaho, University of Idaho Cooperative Extension System, Moscow, Idaho, USA.
- Paulo, S. (2003) *He Will Help You Decide: Mathematician Thomas Saaty*, Exame magazine, 23 April 2003.
- Pearl, J. (1990) "Bayesian Decision Methods", in: *Readings in Uncertain Reasoning*, Shafer, G. & Pearl, J. (eds.), Morgan Kaufmann, San Mateo, California, USA, pp. 345-352.
- Petty, C.B., Leuze, M.R. and Grefenstette, J.J. (1987) A Parallel Genetic Algorithm, *Proceedings of the 2nd International Conference on Genetic Algorithms (ICGA'87)*, Massachusetts Institute of Technology-Cambridge, Massachusetts, USA, 28-31 July 1987, pp. 155-161.
- Pierce, V. and Parcell, J.L. (1999) Setting Farm and Family Goals, *Farm Income Response Strategy Team*, University of Missouri, Missouri, USA.
- Prato, T. (2000) Multiple Attribute Evaluation of Landscape Management, *Journal of Environmental Management*, Vol. 60, No. 4, pp. 325-337.
- Probert, M.E., Keating, B.A., Thompson, J.P. and Parton, W.J. (1995) Modelling Water, Nitrogen, and Crop Yield for a Long-Term Fallow Management Experiment, *Australian Journal of Experimental Agriculture*, Vol. 35, No. 7, pp. 941-950.
- Probert, M.E., Robertson, M.J., Poulton, P.L., Carberry, P.S., Weston, E.J. and Lehane, K.J. (1998) Modelling Lucerne Growth Using Apsim, *Proceedings of the 9th Australian Agronomy Conference*, Wagga Wagga, Australia, pp. 247-250.

- ProFarmer (2005) Making Harvest Decisions: A Grain Growers Guide, *Information Booklet No. 1 (Harvest 2004/05)*, ProFarmer, Grain Growers Association, North Ryde, New South Wales, Australia.
- Pukkala, T. and Miina, J. (1997) A Method for Stochastic Multiobjective Optimization of Stand Management, *Forest Ecology and Management*, Vol. 98, No. 2 SU -, pp. 189-203.
- Rabin, M. (2000) Risk Aversion and Expected-Utility Theory: A Calibration Theorem, *Econometrica*, Vol. 68, No. 5, pp. 1281-1292.
- Rae, A.N. (1971) Stochastic Programming, Utility, and Sequential Decision Problems in Farm Management, *American Journal of Agricultural Economics*, Vol. 53, pp. 448-460.
- Rao, T.R. (2000) *Lis - Issues, Technologies and Standardization (Lis 2000)*, [online]: <http://www.gisdevelopment.net/application/lis/overview/lisrp0011.htm>, accessed (6 May 2003).
- Rasheed, K. (1999) Guided Crossover: New Operator for Genetic Algorithm Based Optimization, *Proceedings of the 1st Congress on Evolutionary Computation (CEC'1999)*, Mayflower Hotel-Washington D.C., USA, pp. 1535-1541.
- Rasheed, K. and Hirsh, H. (1997) Guided Crossover: A New Operator for Genetic Algorithm Based Optimization, *Technical Report HPCD-TR-50*, Rutgers University (Department of Computer Science), New Brunswick, New Jersey, USA.
- Ravan, S. (2002) *Spatial Decision Support System for Biodiversity Conservation*, GIS@development, No. April 2002.
- Rechenberg, I. (1965) Cybernetic Solution Path of an Experimental Problem, *Library translation No. 1122*, Royal Aircraft Establishment, Farnborough, Hants., UK.
- Reeves, G.R. and Hedin, S.R. (1993) A Generalized Interactive Goal Programming Procedure, *Computers and Operations Research*, Vol. 20, No. 7, pp. 747-753.
- Replicators: Evolutionary Powerhouses (2000) *Natural Selection*, [online]: <http://library.thinkquest.org/C004367/be2.shtml>, accessed (22 July 2005).
- Ridley, M. (1993) *Evolution*, Blackwell Scientific, Boston, Massachusetts, USA, 670 pp.
- Rivington, M., Bellocchi, G., Matthews, K.B., Buchan, K. and Donatelli, M. (2004) An Integrated Modelling Approach to Conduct Multi-Factorial Analyses on the Impacts of Climate Change on Whole-Farm Systems, *Proceedings of the 2nd Biennial Meeting of the International Environmental Modelling and Software Society (iEMSs'2004): Complexity and Integrated Resources Management*, University of Osnabrück, Germany, 14-17 June 2004.

- Rivington, M., Matthews, K.B., Sibbald, A.R. and Stöckle, C.O. (2001) Integrating Cropsyst with a Multiple-Objective Land Use Planning Tool (Ladss), *Proceedings of the 2<sup>nd</sup> International Symposium Modelling Cropping Systems*, Florence, Italy, 16-18 July 2001, pp. 171-172.
- Robertson, M.J., Carberry, P.S., Chauhan, Y.S., Ranganathan, R. and O'Leary, G.J. (2001a) Predicting Growth and Development of Pigeonpea: A Simulation Model, *Field Crops Research*, Vol. 71, No. 3, pp. 195-210.
- Robertson, M.J., Carberry, P.S., Huth, N.I., Turpin, J.E., Probert, M.E., Poulton, P.L., Bell, M.J., Wright, G.C., Yeates, S.J. and Brinsmead, R.B. (2002) Simulation of Growth and Development of Diverse Legume Species in Apsim, *Australian Journal of Agricultural Research*, Vol. 53, No. 4, pp. 429-446.
- Robertson, M.J., Holland, J.F., Cawley, S., Bambach, R.W., Cocks, B. and Watkinson, A.R. (2001b) Phenology of Canola Cultivars in the Northern Region and Implications for Frost Risk, *Proceedings of Agronomy Conference*, Hobart, Tasmania, Australia.
- Robertson, M.J., Holland, J.F., Kirkegaard, J.A. and Smith, C.J.N. (1999) Simulating Growth and Development of Canola in Australia, *Proceedings of the 10th International Rapeseed Congress*, Canberra ACT, Australia, 26-29 September 1999.
- Ronald, E.M.A. (1995) When Selection Meets Seduction, *Proceedings of the 6<sup>th</sup> International Conference on Genetic Algorithms (ICGA'95)*, Pittsburgh, Pennsylvania, USA, 15-19 July 1995, pp. 167-173.
- Rowe, J.E., Vinsen, K. and Marvin, N. (1996) Parallel Gas for Multiobjective Functions, *Proceedings of the 2<sup>nd</sup> Nordic Workshop on Genetic Algorithms and their Applications (2NWGA)*, Vaasa, Finland, 21- 23 August 1996, pp. 61-70.
- Rudolphi, W. and Haider, W. (2004) Visitor Management and Ecological Integrity: One Example of an Integrated Management Approach Using Decision Analysis, *Journal for Nature Conservation*, Vol. 11, No. 4, pp. 346-354.
- Rural Policy and Communications Division Agricultural, Fisheries and Forestry (AFFA), (2000) D2 an Overview of Income Risk Management Practise and Policies in Australia, *Proceedings of the Organisation for Economic Co-operation and Development (OECD) Workshop on Income Risk Management in Agriculture*, Paris, France, 15-16 May 2000, pp. 139-146.
- Ryan, C. (1996) Reducing Premature Convergence in Evolutionary Algorithms, *Doctor of Philosophy Thesis*, Computer Science Department, University College Cork, Cork, Ireland, 132 pp.
- Ryan, C. (1995) Racial Harmony and Function Optimization in Genetic Algorithms-the Races Genetic Algorithm, *Proceedings of the 4th Annual Conference on*

- Evolutionary Programming (EP'1995)*, San Diego, California, USA, 1-3 March 1995, pp. 109-125.
- Saaty, T.L. (1997) That Is Not the Analytic Hierarchy Process: What the AHP Is and What It Is Not, *Journal of Multi-Criteria Decision Analysis*, Vol. 6, No. 6, pp. 324-335.
- Sadras, V. and Roget, D. (2002) Rainfall Forecasting Rule Benefits Crop Plans, *Farming Ahead No.127*, CSIRO Land and Water, Canberra ACT, Australia, pp. 28-30.
- Sahinidis, N.V. (2004) Optimization under Uncertainty: State-of-the-Art and Opportunities, *Computers and Chemical Engineering*, Vol. 28, pp. 971-983.
- Saliby, E. (1997) Descriptive Sampling: An Improvement over Latin Hypercube Sampling, *Proceedings of the 29th Winter Simulation Conference*, Atlanta, Georgia, USA, 7 - 10 December 1997, pp. 230-233.
- Saliby, E. (1990) Descriptive Sampling: A Better Approach to Monte Carlo Simulation, *Journal of Operational Research Society*, Vol. 41, pp. 1133-1142.
- Saliby, E. and Pacheco, F. (2002) An Empirical Evaluation of Sampling Methods in Risk Analysis Simulation: Quasi-Monte Carlo, Descriptive Sampling, and Latin Hypercube Sampling, *Proceedings of the 34th Winter Simulation Conference*, San Diego, California, USA, 9 - 12 December 2001, pp. 7-16.
- Saltelli, A., Chan, K. and Scott, E.M. (eds.) (2000) *Sensitivity Analysis*, John Wiley & Sons, New York, USA.
- Sareni, B. and Krahenbuhl, L. (1998) Fitness Sharing and Niching Methods Revisited, *IEEE Transactions on Evolutionary Computation*, Vol. 2, No. 3, pp. 97-106.
- Savage, L.J. (1954) *Foundations of Statistics*, John Wiley & Sons, New York, USA.
- Scanlan, C., Fisher, J., Bowden, B., Asseng, S. and Robertson, M.J. (2003) Fitting 101 Seasons into One Day - a Database of Predicted Wheat Yield, *Proceedings of the 11th Australian Agronomy Conference*, Geelong, Victoria, Australia, 2-6 February 2003.
- Schaffer, J.D. (1985) Multiple Objective Optimization with Vector Evaluated Genetic Algorithms, *Proceedings of the 1st International Conference on Genetic Algorithms (ICGA'85)*, Carnegie Mellon University, Pittsburgh, USA, July 1985, pp. 93-100.
- Schilizzi, S.G.M. and Kingwell, R.S. (1999) Effects of Climatic and Price Uncertainty on the Value of Legume Crops in a Mediterranean-Type Environment, *Agricultural Systems*, Vol. 60, No. 1, pp. 55-69.
- Schlierkamp-Voosen, D. and Mühlenbein, H. (1996) Adaptation of Population Sizes by Competing Subpopulations, *Proceedings of the 3rd IEEE International*

- Conference on Evolutionary Computation (IEEE/ICEC'96)*, Nayoya University, Japan, 20-22 May 1996, pp. 330-335.
- Schoknecht, N. (2002) Soil Groups of Western Australia : A Simple Guide to the Main Soils of Western Australia, *Resource Management Technical Report 246*, Department of Agriculture, Perth, Western Australia.
- Schwefel, H.P. (1981) *Numerical Optimization of Computer Models*, John Wiley & Sons, Chichester, UK, 389 pp.
- Sen, P. (2001) Communicating Preferences in Multiple-Criteria Decision-Making: The Role of the Designer, *Journal of Engineering Design*, Vol. 12, No. 1, pp. 15-24.
- Seppälä, J. (2003) Life Cycle Impact Assessment Based on Decision Analysis, *Doctor of Science in Technology Thesis*, Department of Engineering Physics and Mathematics: Systems Analysis Laboratory, Helsinki University of Technology, Espoo, Finland.
- Shafer, G. (1992) "The Dempster-Shafer Theory", in: *Encyclopedia of Artificial Intelligence, Second Edition*, Shapiro, S. C. (ed.), John Wiley & Sons, pp. 330-331.
- Shafer, G. (1976a) *A Mathematical Theory of Evidence*, Princeton University Press, Princeton, New Jersey, USA.
- Shafer, G. (1976b) *A Mathematical Theory of Evidence*, Princeton University Press, Princeton, New Jersey, USA, 297 pp.
- Simons, R. (1995) *Planning and Scheduling Bp's Oil Refineries — New and Old Approaches*, The Newsletter of Mathematical Programming in Industry and Commerce.
- Sinha, S.M. (2006) 'Mathematical Programming: Theory and Methods', Elsevier Science, p. 572.
- Smets, P. (1997) "Imperfect Information : Imprecision - Uncertainty", in: *Uncertainty Management in Information Systems from Needs to Solutions*, Motro, A. & Smets, P. (eds.), Kluwer Academic Publishers, pp. 225-254.
- Smets, P. (1991) Varieties of Ignorance and the Need for Well-Founded Theories, *Information Sciences*, Vol. 57-58, pp. 135-144.
- Smets, P. (1990) "Constructing the Pignistic Probability Function in a Context of Uncertainty", in: *Uncertainty in Artificial Intelligence 5*, Vol. 10, Henrion, M., Shachter, R. D., Kanal, L. N. & Lemmer, J. F. (eds.), North-Holland, Amsterdam, The Netherlands, pp. 29-39.
- Smith, R.E., Forrest, S. and Parelson, A.S. (1992) Searching for Diverse, Cooperative Population with Genetic Algorithms, *TCGA Report NO. 92002*, The

Clearinghouse for Genetic Algorithms, Department of Engineering Mechanics, The University of Alabama.

- Söderberg, H. and Kärrman, E. (2003) *Mika - Methodologies for Integration of Knowledge Areas: The Case of Sustainable Urban Water Management, Rapport 2003:15*, Department of Built Environment & Sustainable Development, Chalmers Architecture, Chalmers University of Technology, Göteborg, Sweden.
- Spears, W.M. (1994) Simple Subpopulation Schemes, *Proceedings of the 3rd Annual Conference on Evolutionary Programming (EP'1994)*, San Diego, California, USA, pp. 296-307.
- Spears, W.M., de Jong, K.A., Bäck, T., Fogel, D.B. and de Garis, H. (1993) An Overview of Evolutionary Computation, *Proceedings of the European Conference on Machine Learning*, pp. 442-459.
- Spradlin, T. (1997) *A Lexicon of Decision Making*, [online]: <http://faculty.fuqua.duke.edu/daweb/lexicon.htm>, accessed (25 April 2003).
- Srinivas, N. and Deb, K. (1994) Multiobjective Function Optimization Using Nondominated Sorting Genetic Algorithms, *Evolutionary Computation Journal*, Vol. 2, No. 3, pp. 221-248.
- Srinivasa Raju, K. and Duckstein, L. (2004) Integrated Application of Cluster and Multicriterion Analysis for Ranking Water Resources Planning Strategies: A Case Study in Spain, *Journal of Hydroinformatics*, Vol. 6, No. 4, pp. 295-307.
- Steinbrunn, M., Moerkotte, G. and Kemper, A. (1997) Heuristic and Randomized Optimization for the Join Ordering Problem, *Very Large Data Bases (VLDB) Journal*, Vol. 6, No. 3, pp. 191-208.
- Strange, N. (2000) *Studies in Methods for Decision Making in Multi-Use Forestry, Doctor of Philosophy Thesis*, Department of Economics and Natural Resources, The Royal Veterinary and Agricultural University, Copenhagen, Denmark, 266 pp.
- Suhaedi, E., Metternicht, G. and Lodwick, G. (2002) Geographic Information Systems and Multiple Goal Analysis for Spatial Land Use Modelling in Indonesia, *Proceedings of the 23<sup>rd</sup> Asian Conference on Remote Sensing (ACRS'2003)*, Kathmandu, Nepal, 23-25 November 2002.
- Suzuki, H. (1998) Evolution of a Novel Function Facilitated by Genetic Recombination in Genetic Algorithms, *Doctor of Science in Biology Thesis*, Division of Science, Kyushu University, Kyushu, Japan, 105 pp.
- Swayne, D.A. and Shi, J. (2004) Possible Courses: Multi-Objective Modelling and Decision Support Using a Bayesian Network Approximation to a Nonpoint Source Pollution Model, *Proceedings of the 2nd Biennial Meeting of the International Environmental Modelling and Software Society (iEMSs'2004)*:



*Complexity and Integrated Resources Management*, University of Osnabrück, Germany, 14-17 June 2004.

- Syswerda, G. (1989) Uniform Crossover in Genetic Algorithms, *Proceedings of the 3rd International Conference on Genetic Algorithms (ICGA'89)*, George Mason University-Fairfax, Virginia, United States, June 1989, pp. 2-9.
- Tanese, R. (1989) Distributed Genetic Algorithms, *Proceedings of the 3rd International Conference on Genetic Algorithms (ICGA'89)*, George Mason University-Fairfax, Virginia, United States, June 1989, pp. 434-439.
- Tauer, L. (1983) Target Motad, *American Journal of Agricultural Economics*, Vol. 65, pp. 606-610.
- Teclé, A., Duckstein, L. and Korhonen, P.J. (1994) Interactive Multiobjective Programming for Forest Resources Management, *Applied Mathematics and Computation*, Vol. 63, pp. 75-93.
- Teclé, A. and Fogel, M. (1987) Multicriterion Forest Watershed Resources Management, *Proceedings of the Vancouver Symposium: Forest Hydrology and Watershed Management*, August 1987, pp. 617-625.
- Teo, J.T.W. (2003) Pareto Multi-Objective Evolution of Legged Embodied Organisms, *Doctor of Philosophy Thesis*, School of Computer Science, University of New South Wales, New South Wales, Australia, 281 pp.
- Thompson, W.A., Vertinsky, I., Scheier, H. and Blackwell, B.A. (1998) Using Forest Fire Hazard Modelling in Multiple Use Forest Management Planning, *WP 1998-11*, Sustainable Forest Management Network, Vancouver, British Columbia, Canada, pp. 1-26.
- Thomsen, R. and Krink, T. (2002) Self-Adaptive Operator Scheduling Using the Religion-Based Ea, *Proceedings of the 7th International Conference on Parallel Problem Solving from Nature (PPSN VII)*, Granada, Spain, 7-11 September 2002, pp. 214-223.
- Ting, C.K., Li, S.T. and Lee, C. (2003) On the Harmonious Mating Strategy through Tabu Search, *Information Sciences*, Vol. 156, No. 3-4, pp. 189-214.
- Ting, C.K., Li, S.T. and Lee, C. (2001) TGA: A New Integrated Approach to Evolutionary Algorithms, *Proceedings of the 3rd Congress on Evolutionary Computation (CEC'2001)*, Seoul, South Korea, 27-30 May 2001, pp. 917-924.
- Torkamani, J. (2005) Using a Whole-Farm Modelling Approach to Assess Prospective Technologies under Uncertainty, *Agricultural Systems*, Vol. 85, No. 2, pp. 138-154.
- Tozer, P.R. and Stokes, J.R. (2001) A Multi-Objective Programming Approach to Feed Ration Balancing and Nutrient Management, *Agricultural Systems*, Vol. 67, No. 3, pp. 201-215.

- Treasury Board of Canada Secretariat (1998) *Benefit Cost Analysis Guide*, [online]: [http://www.tbs-sct.gc.ca/fin/sigs/Revolving\\_Funds/bcag/BCA2\\_e.asp](http://www.tbs-sct.gc.ca/fin/sigs/Revolving_Funds/bcag/BCA2_e.asp), accessed (18 October 2005).
- Tuson, A.L. and Ross, P. (1998) Adapting Operator Settings in Genetic Algorithms, *Evolutionary Computation*, Vol. 6, No. 2, pp. 161-184.
- U.S. EPA (1997) Guiding Principles for Monte Carlo Analysis, *EPA 540-R97-006*, US Environmental Protection Agency, National Center for Environmental Assessment, Washington, DC, USA.
- University of Michigan (2005) *Evolution and Natural Selection*, [online]: <http://www.globalchange.umich.edu/globalchange1/current/lectures/selection/selection.html>, accessed (21 July 2005).
- USDA-ARS (1998) *GPFARM Information System*, [online]: <http://infosys.ars.usda.gov/>, accessed (7 May 2003).
- USDA-NRCS (1997) *Land Use Planning: It All Comes Down to Soil Building a Comprehensive, Sustainable Community Plan with NRCS Soils Data and Other Natural Resource Information*, [online]: <http://www.il.nrcs.usda.gov/engineer/LUPBro.html>, accessed (5 May 2003).
- Valderrama, D. and Engle, C.R. (2000) A Risk Programming Model for Shrimp Farming in Honduras, *Proceedings of the International Institute of Fisheries Economics and Trade (IIFET 2000)*, Corvallis, Oregon, USA, July 10-15, 2000.
- van Oosterom, E.J., Carberry, P.S., Hargreaves, J.N.G. and O'Leary, G.J. (2001a) Simulating Growth, Development, and Yield of Tillering Pearl Millet: II Leaf Area Profiles on Main Shoots and Tillers, *Field Crops Research*, Vol. 72, No. 1, pp. 51-66.
- van Oosterom, E.J., Carberry, P.S., Hargreaves, J.N.G. and O'Leary, G.J. (2001b) Simulating Growth, Development, and Yield of Tillering Pearl Millet: II Simulation of Canopy Development, *Field Crops Research*, Vol. 72, No. 1, pp. 67-91.
- van Oosterom, E.J., Carberry, P.S., Hargreaves, J.N.G. and O'Leary, G.J. (2001c) Simulating Growth, Development, and Yield of Tillering Pearl Millet: III Biomass Accumulation and Partitioning, *Field Crops Research*, Vol. 72, No. 1, pp. 85-106.
- van Veldhuizen, D.A. (1999) Multiobjective Evolutionary Algorithms: Classifications, Analyses, and New Innovations, *Doctor of Philosophy Thesis*, Department of Electrical and Computer Engineering Graduate School of Engineering, Air Force Institute of Technology, Wright-Patterson AFB, Ohio, USA.

- van Veldhuizen, D.A. and Lamont, G.B. (2000a) Multiobjective Evolutionary Algorithms: Analyzing the State-of-the-Art, *Evolutionary Computation*, Vol. 8, No. 2, pp. 125-147.
- van Veldhuizen, D.A. and Lamont, G.B. (2000b) Multiobjective Optimization with Messy Genetic Algorithms, *Proceedings of the 2000 ACM Symposium on Applied Computing*, Como, Milan, Italy, pp. 470-476.
- Vanderbei, R.J. (2001) *Linear Programming: Foundations and Extensions*, (2nd edn), Kluwer.
- Varis, O. (1997) Bayesian Decision Analysis for Environmental and Resource Management, *Environmental Modelling and Software*, Vol. 12, pp. 177-185.
- Vemuri, V.R. and Cedeño, W. (1996) A New Genetic Algorithm for Multi-Objective Optimization in Water Resource Management, *Proceedings of the 1996 Knowledge-based Computer Systems KBCS*, Bombay, India, December 1996.
- Vere, D.T., Jones, R.E. and Griffith, G.R. (1997) An Integrated Economic Methodology for Evaluating the Impacts of Weeds in Agricultural Production Systems and the Farm and Industry Benefits of Improved Weed Management, *CRC for Weed Management Systems Technical Series No. 2, January 1997*, Cooperative Research Centre for Weed Management Systems (Established and supported under the Commonwealth Government's Cooperative Research Centres Program, CRC).
- Vincke, P. (1992) *Multicriteria Decision-Aid*, John Wiley & Sons, Chichester, UK, 152 pp.
- von Mises, L. (1978) *The Ultimate Foundation of Economic Science: An Essay on Method*, (2<sup>nd</sup> edn), Sheed Andrews and McMeel, Kansas City, Kansas, USA.
- von Neumann, J. and Morgenstern, O. (1953) *Theory of Games and Economic Behaviour*, (3<sup>rd</sup> edn), Princeton University Press, Princeton, New Jersey, USA, 641 pp.
- Voorbraak, F. (1989) A Computationally Efficient Approximation of Dempster-Shafer Theory, *International Journal of Man-Machine Studies*, Vol. 30, No. 5, pp. 525-536.
- WA Department of Agriculture (Undated) *An Introduction to Midas*, [online]: <http://agspsrv34.agric.wa.gov.au/progserv/market/midas/index.htm>, accessed (15 June 2006).
- Walley, P. (2000) "Imprecise Probabilities", in: *The Encyclopedia of Statistical Sciences*, Read, C. B., Banks, D. L. & Kotz, S. (eds.), Wiley, New York, USA.
- Walley, P. and de Cooman, G. (2001) A Behavioral Model for Linguistic Uncertainty, *Information Sciences*, Vol. 134, No. 1-4, pp. 1-37.

- Wang, E., Hammer, G.L., Meinke, H., Carberry, P.S., Holzworth, D., Robertson, M.J., Huth, N.I., Chapman, S. and McLean, G. (2001) Development of a Generic Crop Module Template in Apsim, *Proceedings of the 2nd International Symposium on Modelling Cropping Systems*, Florence, Italy, 15-18 July 2001, pp. 231-232.
- Wang, H., Cai, G. and Cheng, Q. (2002) Data Integration Using Weights of Evidence Model: Applications in Mapping Mineral Resource Potentials, *Proceedings of the ISPRS Commission IV 2002 Symposium*, Ottawa, Canada, pp. 268-273.
- Warren, G. (2007) Developing Land Management Units Using Geospatial Technologies: An Agricultural Application., *Doctor of Philosophy Thesis*, Department of Spatial Science, Curtin University of Technology, Perth, 329 pp.
- Warren, G., Metternicht, G. and Speijer, J. (2006) Use of a Spatially Weighted Multivariate Classification of Soil Properties, Terrain and Remote Sensing Data to Form Land Management Units, *Proceedings of American Society for Photogrammetry and Remote Sensing Annual Conference*, Reno, Nevada, USA, 1-5 May 2006, p. 12.
- Watkins, D.W., McKinney, D.C., Maidment, D.R. and Lin, M.D. (1996) Use of Geographic Information Systems in Ground-Water Flow Modeling, *Journal of Water Resources Planning and Management*, ASCE, Vol. 122, pp. 88-96.
- Weerakoon, K.G.P.K. (2002) Integration of GIS Based Suitability Analysis and Multi Criteria Evaluation for Urban Land Use Planning; Contribution from the Analytic Hierachy Process, *Proceedings of the 23<sup>rd</sup> Asian Conference on Remote Sensing (ACRS'2003)*, Birendra International Convention Centre, Kathmandu, Nepal, 25-29 November 2002.
- Weinzierl, S. (2000) Introduction to Monte Carlo Methods, *NIKHEF-00-012, hep-ph/0006269*, Research School Subatomic Physics, Amsterdam, the Netherlands.
- White, D.J. (1984) *Optimality and Efficiency*, John Wiley & Sons, New York, USA, 583-599 pp.
- Wierzbicki, A.P. and Makowski, M. (1992) Multi-Objective Optimization in Negotiation Support, *WP-92-007*, International Institute for Applied Systems Analysis, Laxenburg, Austria, pp. 1-27.
- Winkler, R.L. (1996) Uncertainty in Probabilistic Risk Assessment, *Reliability Engineering and System Safety*, Vol. 54, No. 2-3, pp. 127-132.
- Wright, J. and Loosemore, H. (2001) The Multi-Criterion Optimization of Building Thermal Design and Control, *Proceedings of the 7th International IBPSA Conference*, Rio de Janeiro, Brazil, 13-15 August 2001, pp. 873-880.

- Young, D.L. (1984) "Risk Concepts and Measures for Decision Analysis", in: *Risk Management in Agriculture*, Barry, P. J. (ed.), Iowa State University Press, Iowa, USA, pp. 31-42.
- Yu, P.L. (1985) *Multiple-Criteria Decision Making: Concepts, Techniques, and Extensions*, Plenum Publisher Corporation, New York. USA.
- Yu, P.L. (1973) A Class of Decisions for Group Decision Problems, *Management Science*, Vol. 19, pp. 936-946.
- Zadeh, L.A. (1978) Fuzzy Sets as a Basis for a Theory of Possibility, *Fuzzy Sets and Systems*, Vol. 1, pp. 3-28.
- Zadeh, L.A. (1965a) Fuzzy Sets, *Information and Control*, Vol. 8, pp. 338-353.
- Zadeh, L.A. (1965b) "Fuzzy Sets and Systems", in: *Systems Theory*, Fox, J. (ed.), Polytechnic Press, Brooklyn, New York, USA, pp. 29-37.
- Zanakis, S.H., Solomon, A., Wishart, N. and Dublish, S. (1998) Multi-Attribute Decision Making: A Simulation Comparison of Select Methods, *European Journal of Operational Research*, Vol. 107, No. 3, pp. 507-529.
- Zeleny, M. (1982) *Multiple Criteria Decision Making*, McGraw-Hill, New York, USA.
- Zeleny, M. (1976) "The Theory of the Displaced Ideal", in: *Multi-Criteria Decision Making*, Zeleny, M. (ed.), Springer-Verlag, Berlin, Germany.
- Zeleny, M. (1973) *Compromise Programming-Multiple Criteria Decision Making*, Columbia: University of South Carolina Press.
- Zhaksilikov, M. and Harris, F.C.J. (1996) Comparison of Different Implementations of Parallelization of Genetic Algorithms, *Proceedings of the ISCA International Conference on Intelligent Systems (IS '96)*, Reno, NV, June 1996.
- Zhao, Z. (2002) Design Decision Making in Gloable Manufacturing Enterprise in 2020, *Proceedings of NSF Student Design Essay Competition Paper, ASME Design Engineering Technical Conferences and Computers and Information in Engineering Conference*, Montreal, Canada, September 2002.
- Zhu, M., Taylor, D.B., Sarin, S. and Kramer, R.A. (1994) Chance Constrained Programming Models for Risk-Based Economic and Policy Analysis of Soil Conservation, *Agriculture and Resource Economics Review*, Vol. 23, pp. 58-65.
- Zitzler, E. (1999) Evolutionary Algorithms for Multiobjective Optimization: Methods and Applications, *Doctor of Philosophy Thesis*, Computer Engineering and Networks Laboratory (TIK), Swiss Federal Institute of Technology (ETH), Swiss Federal Institute of Technology, Zurich, Switzerland, 132 pp.

- Zitzler, E., Laumanns, M. and Thiele, L. (2002) Spea2: Improving the Strength Pareto Evolutionary Algorithm for Multiobjective Optimization, *Proceedings of Evolutionary Methods for Design, Optimisation, and Control (CIMNE)*, Barcelona, Spain, 19-21 September 2001, pp. 95-100.
- Zitzler, E. and Thiele, L. (1999) Multiobjective Evolutionary Algorithms: A Comparative Case Study and the Strength Pareto Approach, *IEEE Transactions on Evolutionary Computation*, Vol. 3, No. 4, pp. 257-271.
- Zitzler, E., Thiele, L., Laumanns, M., Fonseca, C.M.M. and da Fonseca, V.G. (2003) Performance Assessment of Multiobjective Optimizers: An Analysis and Review, *IEEE Transactions on Evolutionary Computation*, Vol. 7, No. 2, pp. 117-132.
- Zydallis, J.B., Lamont, G.B. and van Veldhuizen, D.A. (2000) Messy Genetic Algorithm Based Multi-Objective Optimization: A Comparative Statistical Analysis, *Proceedings of Workshop on Multiobjective Problem Solving from Nature*, Paris, France.

*Every reasonable effort has been made to acknowledge the owners of copyright material. I would be pleased to hear from any copyright owner who has been omitted or incorrectly acknowledged*

This page is intentionally blank