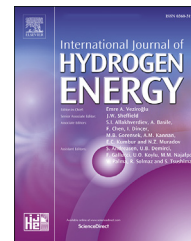

Available online at www.sciencedirect.com

ScienceDirect

journal homepage: www.elsevier.com/locate/hydro

Application of hydrides in hydrogen storage and compression: Achievements, outlook and perspectives

Jose Bellostá von Colbe^a, Jose-Ramón Ares^b, Jussara Baraleⁱ,
 Marcello Bariccoⁱ, Craig Buckley^f, Giovanni Capurso^a, Noris Gallandat^e,
 David M. Grant^j, Matylda N. Guzik^k, Isaac Jacobⁿ, Emil H. Jensen^k,
 Torben Jensen^g, Julian Jepsen^a, Thomas Klassen^a,
 Mykhaylol V. Lototskyy^p, Kandavel Manickam^j, Amelia Montone^h,
 Julian Puszkiel^{a,l}, Sabrina Sartori^k, Drew A. Sheppard^f, Alastair Stuart^j,
 Gavin Walker^j, Colin J. Webb^o, Heena Yang^{c,d}, Volodymyr Yartys^m,
 Andreas Züttel^{c,d}, Martin Dornheim^{a,*}

^a Department of Nanotechnology, Helmholtz-Zentrum Geesthacht, Max-Planck-Str. 59, 21502 Geesthacht, Germany

^b Departamento de Física de Materiales, Facultad de Ciencias, Universidad Autónoma de Madrid, 28049, Madrid, Spain

^c Laboratory of Materials for Renewable Energy (LMER), Institute of Chemical Sciences and Engineering (ISIC), Basic Science Faculty (SB), École Polytechnique Fédérale de Lausanne (EPFL) Valais/Wallis, Energypolis, Sion, Switzerland

^d Empa Materials Science & Technology, Dübendorf, Switzerland

^e GRZ Technologies Ltd., Rue de l'Industrie 17, 1950 Sion, Switzerland

^f Department of Physics and Astronomy, Fuels and Energy Technology Institute, Curtin University, GPO Box U1987, Perth, WA 6845, Australia

^g Department of Chemistry, Aarhus University, Langelandsgade 140, Building 1512, 316, 8000 Aarhus C, Denmark

^h ENEA, Materials Technology Division, Research Centre of Casaccia, Via Anguillarese, 301, 00123 Rome, Italy

ⁱ Chemistry Department and NIS, University of Turin, Via Pietro Giuria, 7, 10125, Torino, Italy

^j Advanced Materials Research Group, Faculty of Engineering, Department of Mechanical, Materials and Manufacturing Engineering, University of Nottingham, University Park, Nottingham, NG7 2RD, UK

^k Department of Technology Systems, University Oslo, P.O. Box 70, NO-2027 Kjeller, Norway

^l Department of Physicochemistry of Materials, Consejo Nacional de Investigaciones Científicas y Técnicas (CONICET) and Centro Atómico Bariloche, Av. Bustillo km 9500 S.C. de Bariloche, Argentina

^m Institute for Energy Technology, Kjeller, NO-2027, Norway

ⁿ Faculty of Engineering Sciences, Ben-Gurion University of the Negev, P.O.B. 653 Beer-Sheva, Israel

^o Queensland Micro- and Nanotechnology Centre, Griffith University, Nathan, Australia

^p HySA Systems (Hydrogen South Africa), University of the Western Cape, Bellville, 7535, South Africa

ARTICLE INFO

Article history:

Received 5 October 2018

Received in revised form

10 January 2019

ABSTRACT

Metal hydrides are known as a potential efficient, low-risk option for high-density hydrogen storage since the late 1970s. In this paper, the present status and the future perspectives of the use of metal hydrides for hydrogen storage are discussed. Since the early 1990s, interstitial metal hydrides are known as base materials for Ni – metal hydride

* Corresponding author.

E-mail address: martin.dornheim@hzg.de (M. Dornheim).

<https://doi.org/10.1016/j.ijhydene.2019.01.104>

0360-3199/© 2019 The Authors. Published by Elsevier Ltd on behalf of Hydrogen Energy Publications LLC. This is an open access article under the CC BY-NC-ND license (<http://creativecommons.org/licenses/by-nc-nd/4.0/>).

Accepted 11 January 2019
Available online 13 February 2019

Keywords:

Hydrogen storage
Hydrogen compression
Metal hydrides

rechargeable batteries. For hydrogen storage, metal hydride systems have been developed in the 2010s [1] for use in emergency or backup power units, i. e. for stationary applications.

With the development and completion of the first submarines of the U212 A series by HDW (now Thyssen Krupp Marine Systems) in 2003 and its export class U214 in 2004, the use of metal hydrides for hydrogen storage in mobile applications has been established, with new application fields coming into focus.

In the last decades, a huge number of new intermetallic and partially covalent hydrogen absorbing compounds has been identified and partly more, partly less extensively characterized.

In addition, based on the thermodynamic properties of metal hydrides, this class of materials gives the opportunity to develop a new hydrogen compression technology. They allow the direct conversion from thermal energy into the compression of hydrogen gas without the need of any moving parts. Such compressors have been developed and are nowadays commercially available for pressures up to 200 bar. Metal hydride based compressors for higher pressures are under development. Moreover, storage systems consisting of the combination of metal hydrides and high-pressure vessels have been proposed as a realistic solution for on-board hydrogen storage on fuel cell vehicles.

In the frame of the “Hydrogen Storage Systems for Mobile and Stationary Applications” Group in the International Energy Agency (IEA) Hydrogen Task 32 “Hydrogen-based energy storage”, different compounds have been and will be scaled-up in the near future and tested in the range of 500 g to several hundred kg for use in hydrogen storage applications.

© 2019 The Authors. Published by Elsevier Ltd on behalf of Hydrogen Energy Publications LLC. This is an open access article under the CC BY-NC-ND license (<http://creativecommons.org/licenses/by-nc-nd/4.0/>).

Introduction

Hydrogen storage is a key enabling technology for the development of a hydrogen and fuel cell based economy. Hydrogen has the highest energy density per unit mass of any fuel; however, its low volumetric density at ambient temperature and pressures correspondingly results in a rather low energy density per unit volume.

Metal hydride materials research focuses on improving both the volumetric and gravimetric capacities, hydrogen absorption/desorption kinetics, and reaction thermodynamics of potential material candidates. Furthermore, long-term cycling effects have to be taken into account for the development of hydrogen-based technologies [2–4].

Materials suitable for hydrogen storage in solid-state have to meet specific requirements in order to be used for the development of hydrogen based technologies, in particular storage. The material has to retain its performances in terms of kinetics and total hydrogen capacity, even after cycling. The reaction of the material with hydrogen must be reversible even after repeated absorption and desorption runs, but in practice powders tend to pack and sinter after long term cycling, reducing the efficiency of the system. One possible solution, which was proven successful more than once [5,6], is compacting the hydride powder into high-density pellets. Powders of hydrides are generally compacted in cylindrical shape, after mixing with additives for enhancing thermal conductivity and mechanical stability (for example Al, Cu or carbon-based materials). It has been reported that compacted systems tend to disaggregate during cycling, thus returning to the initial status of powder in the loose form [7]. This

phenomenon is accompanied by an increase in volume. This swelling mechanism causes rapid slowdown of the kinetics and all the other problems related to the use of powders. Moreover, compacted powders can be much more safely handled and are less prone to deterioration due to contaminations, in particular by moisture and oxygen from air. A procedure to further improve the stability of metal hydrides is to include or embed the hydride in a polymer, as it has been recently studied in the frame of the HyScore project: “Efficient hydrogen storage through novel hierarchical porous core-shell structures with incorporated light metal hydrides” [8]. The deposition of a thin layer of a metal on the surface of the pellet was advantageous, too: coated MgH_2 pellets demonstrated, after 50 hydrogenation/dehydrogenation cycles, variations of dimension eight times lower in comparison to those obtained on pellets prepared without coating [9].

Future prospects to improve efficient gas storage systems should take into account the relationship between structural characteristics of materials such as composition, structure and morphology, and their thermodynamic and kinetic properties obtained by different characterization processes and the methods existing for suitable materials. In particular, proposing novel synthesis routes for energy storage materials and improving the knowledge in advanced materials characterization techniques should be a target of these developments. Additionally, the use of computational tools for the research and development of materials and systems, ought to be more extensive. For very large amounts of material, numerical simulations are necessary to reproduce and then predict the dynamic responses and to compute the macroscopic properties of a system. The materials discovery

approaches based on machine learning techniques, that are used to scan efficiently very large amounts of data and replicate the materials' characteristics in a virtual environment are of special interest in this frame [10]. In order to introduce hydrogen technology to mass markets, a dependence on the availability of critical raw materials (CRMs) for the industry has to be considered. Moreover, the widespread implementation of a hydrogen-based economy is hindered, among other factors, by some technical hurdles, which need to be overcome. Given appropriate materials as described above, the paradigm of hydride usage for hydrogen storage is a completely different one than that of other hydrogen storage forms. Whereas gaseous or liquid hydrogen can be both refueled and used without a direct interaction between the storage and the rest of the host system (aside from the necessary piping to transport hydrogen), the hydride paradigm requires a close coupling of the store and its host system at the heat transfer level. Hydrides, needing a heat supply in order to release hydrogen, have to take it from the waste energy associated with any hydrogen consumer, no matter whether it is a fuel cell, turbine or other type of energy converter. This is the only way to generate a synergy, in which the waste heat emissions are reduced (by using part of it to desorb hydrogen) and correspondingly provide hydrogen from the hydride at a rate suited to the application. Since the rate of hydrogen desorption from the hydride is tied to the amount of heat it receives, the usage of hydrides shows the way for self-regulating systems in the future.

In a recent review, Lototsky et al. [11] have given an overview on hydrogen storage systems, based on storage tanks integrated with fuel cells, realized in recent years using hydrides as solid-state hydrogen carriers (MH). The definition of a hydrogen storage system, aiming to meet the needs required by specific applications, is mainly related to the selection of the proper MH properties and to the design of the container [11]. However, the selected design strongly influences gravimetric and volumetric capacities of the storage system. These two parameters represent the amount of hydrogen stored, respectively, over the weight and volume base of the system. First of all, it is necessary to define the boundaries of the system, which can be described as the tank, the H₂-carrier and the thermal fluid necessary for the heat transfer, neglecting piping and valves used as auxiliaries. The main parameters that influence gravimetric and volumetric density of the hydrogen storage systems are MH properties (i.e. the hydrogen gravimetric and volumetric density of the hydrogen carrier) and the tank geometry. The most common tank geometry is tubular, but it can be also planar or disc-shaped [11]. All variations in geometry are considered to optimize the heat management necessary for the hydrogen sorption reactions. Indeed, the optimization of heat management is crucial [12], since it affects the speed and the efficiency of the H₂ uptake and release. Thus, modelling of the heat management is fundamental, considering MH thermal conductivity properties and the tank geometry [13].

The simplest storage tank consists of two concentric tubes, with the solid-state hydrogen carrier in the inner tube and thermal exchange fluid in the outer one. As an example, a hydrogen storage tank based on LaNi_{4.8}Al_{0.2} to be integrated with a Low Temperature-PEM (LT-PEM) has been realized [1].

The selected hydrogen carrier has a maximum gravimetric density of about 1.4 wt.% H₂. Water was used as the thermal fluid and the working conditions were close to 1 atm of H₂ and 60 °C. The system can operate for 6 h at an average power of 0.76 kW and delivers a total energy of 4.8 kWh, consuming about 3120 Nl of H₂. [1]. Tanks such as this will be described in the following, with particular focus on the requirements and special characteristics associated with the use of hydrides in different applications.

Examples of companies, spin offs, etc. using metal hydrides for stationary applications that are looking at the introduction of hydride technology in various markets are: GRZ Technologies AG, GKN Sinter Metal, Microtek, SSDS: Small scale demonstrator SION, Tomodachi [14] and McPhy-Energy to name just a few.

In the following, applications of hydrides will be divided in two main groups: stationary and mobile ones. They place different requirements on the hydrogen supply and therefore some hydrides are better suited to one or the other. Moreover, the technical solutions to achieve the aforementioned synergies between host and storage system are also different depending on the type of application considered.

Hydrogen storage for stationary applications

Stationary applications do not place demanding requirements on the weight of the storage systems used to supply hydrogen in the majority of cases. Since in most scenarios they can be situated on the ground, the weight of such systems is only limited by the amount of hydrogen that needs to be stored. In these applications, the main advantage of hydrides, namely their compactness, can be used to the full extent. Another advantage is the low pressure operation, especially for off-grid systems. In this regard, off-grid systems are by definition in places where the access is difficult and should not require expert personnel, intensive maintenance and/or repair, as is the case with high-pressure systems. For grid-connected applications, this compactness opens the possibility of storing large amounts of energy in relatively small pieces of real estate. More importantly, they allow the decoupling of the power and energy characteristics of the energy supply system, unlike batteries. Therefore, for a given amount of required power, the increase of stored energy is not associated with an increase of power, which makes the hydrogen-based system more easily expandable and ultimately more cost-effective than its battery counterpart does. Heat storage, is an especially suitable use of hydride, because the aforementioned advantage is coupled to the use of the reaction enthalpy of the hydrogen-hydride reaction to achieve a more compact design than the extant alternatives by orders of magnitude. A niche stationary application is hydrogen compression. Ever since the discovery of hydrogen, mechanical compression was the only available method of increasing the density of gaseous hydrogen, but it is associated with sealing problems in reciprocating or rotating machinery, as hydrogen is a small molecule able to diffuse through extremely small gaps. A completely different approach, free from rotating or reciprocating machinery, is the chemical compression of hydrogen using hydrides. In the following, both theoretical simulation

and experimental, applied results will show to advantage the characteristics of such innovative systems, which offer a promising outlook for low temperature hydrides.

Metal hydrides for off-grid systems

One of the objectives of energy storage via hydrogen is to demonstrate the feasibility of using hydrogen to support integration of renewable energy sources into the energy systems. Hydrogen storage, handling and distribution have to be optimized to allow storage of hydrogen at central or distributed production plants and delivery to the customer base.

There are many locations around the world not connected to the electric energy grid such as remote islands [15] and less-developed countries [16], in addition to public institutions (e.g. hospitals), for which any disruption in electric energy supply could result in serious consequences involving human life. Even though, in most of these places, the use of diesel generators as reliable on-demand power source is still very common, the current energy trends favour implementation of off-grid renewable energy-based technologies. Considering the intermittence of renewable energy sources (RESs) one of the main challenges is the need for storage. Hydrogen storage devices based on metal hydrides have been considered as one viable solution for enabling off-grid installations for power generation and energy storage, as demonstrated by some recent demonstration projects.

One of the first studies discussed the use of metal hydrides for off-grid energy generation/storage systems for farms and mining operations in remote areas of the Australian outback [17], though with a high estimated cost for its implementation. Biemann et al. [18] proposed an energy system for a stand-alone independent living unit (SELF). The electricity generation and storage covered all aspects of living, i.e. space heating and cooking, purified rainwater supply and wastewater treatment. The energy generation unit included PV panels, while energy storage consisted of a PEM electrolyser, a hydrogen storage tank with AB₅-type metal hydrides and a Li-ion battery. The selection of the system components was determined based on the general energy generation/consumption analysis specific for the geographical location of SELF. Various combinations of components in the system were tested. The results demonstrated that hydrogen-based options, with their high energy density, were perfect for the long-term seasonal energy storage, while the battery performed better when used for a short-term storage application.

One of the first systems which coupled a MgH₂-based hydrogen storage tank and a solid-oxide fuel cell (SOFC) was reported by Delhomme et al. [19]. In the tested rig, the high temperature necessary for hydrogen desorption (300–350 °C), was achieved by a heat transfer from the SOFC unit. The setup was operated successfully, but the study underlined the essential role of the heat management system. Its optimization was crucial in reducing undesired pressure and temperature fluctuations, which turned out to be the most destabilizing factors for the system efficiency. Simulations regarding this type of coupling have also been successfully carried out [20], showing that the configuration of the system can be varied considerably, thus influencing the effectiveness of the coupling and therefore the efficiency of the system.

A system based on commercial PEM fuel cell integrated with hydrogen storage tanks filled with 29 kg of LaNi_{4.8}Al_{0.2} was studied by Rizzi et al. [1]. By optimization of the system heat management, the setup was able to produce 4.8 kWh of electricity, at an average power of 0.76 kW, over a period of 6 h. Parra et al. [21] presented an even more advanced system design for seven dwellings. It included PV panels for power generation combined with a PEM electrolyser, a hydrogen storage tank and a PEM fuel cell. In this case, an extra variable was added – a grid connection. It was assumed that the system could benefit from the grid electricity supplied during the off-peak hours, due to much lower electricity import prices. The commercial metal hydride tank was filled with MgH₂ to store up to 4 kg of H₂. The tank was designed to work under pressure of 12 bar H₂ and temperatures up to 390 °C. The system was tested and evaluated mostly in terms of efficiency for a mid- and long-term energy storage and from the perspective of the H₂-storage implementation. The results identified the main obstacles related to the efficiency loss as due to the internal components limitations. The study emphasised the important role on the grid connection that significantly improved the performance of the electrolyser and, in turn, increased the system efficiency.

Bhogilla et al. [22] proposed a totalized hydrogen energy utilization system (THEUS), which comprised a unitized reversible fuel cell (URFC) coupled to a storage tank filled with MmNi₅ hydride. In this case, two heat reservoirs were used to ensure the stability of working temperatures. The setup was operated by using simulated wind power data from 1.1 kW to 1.1 MW wind turbines as well as a 50 MW wind farm, and tested in both water electrolyser (output power: 4.4 kW) and fuel cell (output power: 0.68 kW) modes. The performance of URFC was investigated in terms of stack efficiency and system efficiency, also including heat recovery from the URFC in both modes of operation. The results demonstrated the suitability of URFC and the tested hydride tank for systems with dynamic variations of the input power and showed a strong dependence of the hydrogen production on the latter.

The application of off-grid integrated energy generation and storage systems appears crucial also for industry. Song et al. [23] tested a system for a mobile light tower used on construction sites. Four hydride tanks, with the total H₂-storage capacity of 12 kg, were used together with a 5 kW PEM fuel cell. This allowed for a continuous system operation over a period of 58 h. The heat generated by the fuel cell was used for desorption of hydrogen. The refueling time varied between 3 and 8 h depending on atmospheric conditions. When compared to the commonly used diesel counterpart, the hydrogen storage system was quieter, lasted longer, and reduced significantly the CO₂ emission. However, the setup refueling time was longer, and its total cost was significantly higher.

The Sir Samuel Griffith Centre at Griffith University in Brisbane is a demonstration building for clean energy which uses MH reservoirs supplied by Japan Steel Works to store 120 kg H₂. Power is provided by PV panels on the roof with a peak effective output of 320 kW. Inverters use this power for the building and run electrolysers to generate hydrogen when there is spare PV power. 2 × 30 kW PEM fuel cells provide

power from the hydrogen store when required. When complete, it will also have a fully instrumented control system for monitoring and for research projects [24].

In 2016, Toshiba Corporation launched a hydrogen-based autonomous energy supply system called H2One™ [25]. The unit integrated a photovoltaic power generation system (62 kW) with batteries for storing output power, an electrolyser, a hydrogen storage metal hydride tank, also supplied by Japan Steel Works, and a fuel cell (54 kW). H2One™ was installed as an environmentally friendly energy supply for 12 hotel rooms. The energy management system was optimized to ensure that intermittent power generation would satisfy energy demand (electricity and hot water) regardless of the season. The entire system was modularized and housed in shipping containers, enabling easy transport to remote areas or for emergency relief.

For much larger energy storage needs, Kubo et al. [26] proposed a tank with a hydrogen storage capacity of 1000 Nm³. Vessels were filled with 7.2 tons of polymer-enhanced AB₅-based alloy. This allowed for a uniform distribution of metal hydrides and reduced the strain in the tank material. The system operating temperatures oscillated between 25 and 35 °C and hydrogen desorption rates reached 70 Nm³/h.

Metal hydrides for smart-grid energy storage

Off-grid systems, as those presented in the previous paragraph, pose peculiar challenges, including following the availability of Renewable Energy Sources (RESs). They need to rely completely on the energy stored, but can work independently. Energy storage integrated into a network, on the other hand, has to balance the production and fulfil demand with a management system. This is required to optimize the overall efficiency and to minimize the operational losses.

An example of such a management system in a smart-grid involving the use of hydrogen and hydrides is described in the HyLab laboratory experiment [27]. In this setup, a 7 Nm³ hydrogen storage tank is completely integrated in a small smart-grid together with PEM electrolyser, PEMFC and a battery. Interestingly, in addition to the safety and the low-pressure operation, the metal hydride tank did not display any loss of its original storage capacity, while a remarkable loss of capacity in the battery bank was observed.

In larger stationary applications as well, the volume occupied by the storage system can be more of a concern than its mass. In this situation, hydrides present interesting features, and even intermetallic alloys could be a promising and competitive solution [28].

One case study, where this advantage is carefully evaluated to assess the feasibility of large energy storages, is proposed in the work by Lohner et al. [29]. This is also an example, in which hydrogen would not be processed only in a fuel cell, but mainly in a coal gasification unit with pre-combustion carbon capture and storage, and in a Molten Carbonate Fuel Cell (MCFC) as backup. The integration of the hydrogen storage system allows the accumulation of energy produced in excess (due to the intermittent nature of renewable sources or to the oscillating power demand) and its use when needed, reaching higher load factors and efficiency levels. In the study,

the use of hydride (AB₅, NaAlH₄, and especially MgH₂) drastically reduce the volume required to store 300 GWh of energy [29]. Another instance, where the storage of hydrogen in different metal hydrides is coupled within a natural gas combined cycle plant, has been simulated using Na₃AlH₆ or MgH₂ [30]. Here, the focus is rather on the increased flexibility of such a system, to match energy demand fluctuations.

Regenerative fuel cells coupled to a hydrogen reservoir can also be used for electrical energy storage in an analogous system to the one described above (THEUS) [31], incorporated in the grid. Similar to what was observed before for independent living units [18], the use of hydrogen in comparison with batteries becomes competitive in a long term seasonal storage and, therefore, hydrides and their high useful energy density are an appealing solution.

Solid-state hydrogen storage solutions have been developed also by McPhy-Energy, using MgH₂ based composites in modular systems [32]. The hydrogen can be reversibly stored and re-injected in the grid, in units in the scale from kWh to GWh of energy. This effort would become meaningful in industrial applications with the use of CO₂-free hydrogen produced with electrolysis [33].

In a larger scenario, where bulk hydrogen storage is needed for reasons of energy security (when relying on renewable sources), the most suitable methods include metal or chemical hydrides, among others [34]. Massive storage would be necessary prior to local distribution; therefore, given the huge amount of hydrogen and storage material that would be needed, material availability could become the main issue in this case.

Hydrides for hydrogen storage in heat storage applications

Stationary applications that require hydrogen storage in low-temperature metal hydrides (LTMH) have recently been reviewed [11,35]. One main application of LTMHs for stationary hydrogen storage is as part of a closed thermochemical heat storage system in Concentrating Solar Power (CSP) plants. In this scenario, hydrogen is neither created nor consumed, but it is cycled between the hydrogen store, a LTMH, and the heat storage/generation system, a highly endothermic/exothermic high-temperature metal hydride, HTMH [36–49]. A further area of current research on hydrogen storage in LTMHs is exploring their potential to store hydrogen produced from a renewably-powered sources. It is interesting when the hydrogen can be released, as needed, to a fuel cell to generate electricity [11,35].

A number of different types of low-temperature metal hydrides show promise for stationary hydrogen storage as part of either a heat storage cycle or an electrolyser/fuel cell cycle (Table 1). Intermetallic hydrides, typically based on titanium, such as AB₂ type Hydralloy C5 [50] and AB type TiFeH_x [51], have favorable kinetic behavior as well as thermodynamics and hydrogen equilibrium pressures that can easily be tailored via elemental substitution, to match the requirements of a particular application [52]. Their main drawbacks are that they suffer from a low gravimetric hydrogen capacity (<2 wt.% H₂) and high cost [53]. In some cases, harsh activation processes are necessary to use them [54]. They often

Table 1 – Properties of various low-temperature metal hydrides candidates for stationary hydrogen storage applications.

Hydride Materials	Theor. H ₂ capacity (wt.%)	$\Delta H_{des}/\Delta H_{abs}$ (kJ/mol.H ₂)	$\Delta S_{des}/\Delta S_{abs}$ (J/mol.H ₂ .K)	Hydride Crystal Density (g/cm ³)	Theor. kg-H ₂ /m ³ wrt to hydride	Cost of H ₂ Storage (US\$/kg-H ₂) ^a	1 bar H ₂ Desorption Temperature (°C)
<i>Complex Hydrides</i>							
NaAlH ₄ ↔ 1/3Na ₃ AlH ₆ + 2/3Al + H _{2(g)}	3.73	38.4/-35.2 [66]	126.3/-118.1 [66]	1.251	46.7	107.2	31 ^b
Na ₃ AlH ₆ ↔ 3NaH + Al + 3/2H _{2(g)}	2.96	47.6/-46.1 [66]	126.1/-123.8 [66]	1.455	43.1	120.6	104
NaAlH ₄ ↔ Na ₃ AlH ₆ ↔ NaH + Al + 3/2H _{2(g)}	5.60	n.a.	n.a.	1.251	70.1	71.4	n.a.
Na ₂ LiAlH ₆ ↔ 2NaH + LiH + Al + 3/2H _{2(g)}	3.52	54.95/n.a [67,68].	135/n.a [67,68].	1.405	49.4	n.a.	134
K ₂ LiAlH ₆ ↔ 2 KH + LiH + Al + 3/2H _{2(g)}	2.56	n.a.	n.a.	1.571	40.2	n.a.	n.a.
KAlH ₄ +LiCl ↔ KCl + LiH + Al+3/2H _{2(g)} [69]	2.69	37.6/-37.6 ^c	97.9/-97.9 ^c	1.457 ^d	39.2	n.a.	111
Mg(NH ₂) ₂ + 2LiH ↔ Li ₂ Mg(NH) ₂ + 2H _{2(g)}	5.58	38.9/n.a [70].	112.0/n.a [70].	1.182 ^d	65.9	n.a.	75
<i>Intermetallic Hydrides</i>							
AB ₂ type - Hydralloy C5: Ti _{0.909} Zr _{0.052} Mn _{1.498} V _{0.439} Fe _{0.086} Al _{0.016} H ₃ [50]	1.88	28.3/-22.5 [50]	111.9/-97.2 [50]	5.0 ^e	93.8	n.a.	-20.7
Ti _{1.2} Mn _{1.8} H ₃	1.90	28.7/n.a [52].	114/n.a [52].	5.23 ^f	99.2	321.5	-21.4
TiFeH _{2.0} ↔ TiFeH _{1.04} [51]	0.91	n.a. ^g	n.a. ^g	5.47 [51]	50.0	n.a.	n.a. ^g
TiFeH _{1.04} ↔ TiFeH _{0.1} [51]	0.90	28.1/n.a [51].	106.3/n.a [51].	5.88 [51]	53.2	n.a.	-9
TiFeH _{2.0} ↔ TiFeH _{1.04} ↔ TiFeH _{0.1} [51]	1.81	n.a.	n.a.	5.47	99.1	n.a.	n.a.

“n.a.” = Either the field not applicable, the data not available or the data was not obtained from the literature.

^a Based on theoretical gravimetric hydrogen capacity. Raw material alloy cost of US\$6.10/kg taken from Ref. [39] based on use of Ti-sponge as a starting material. Raw material cost of US\$3.20/kg for NaAlH₄ and US\$4.00/kg for NaH were taken from Ref. [62].

^b The 1 bar H₂ desorption pressure is calculated based on the thermodynamics of the system. In practise, however, temperatures above -100 °C are required for reasonable kinetics.

^c There are some discrepancies in the reported thermodynamics for KAlH₄. The enthalpy of formation of KAlH₄, $\Delta H_f^\circ = -175.4$ kJ/mol, was taken as the average of the values reported in Refs. [71,72] while the entropy of KAlH₄, $S^\circ = 120.9$ J/mol.H₂.K, was taken as the average of the values reported in Refs. [71,73].

^d Calculated using the molar volume of Mg(NH₂)₂ [74] and LiH [75], stoichiometry and total molar mass of the hydride reagents.

^e Calculated using the reported density, 6.1 g/cm³, for hydrogen-free intermetallic Hydralloy C5 [64] and assuming a volume expansion of 22% upon hydriding [76].

^f Derived using crystal density of 6.38 g/cm³ calculated from reported lattice constants of Ti_{1.2}Mn_{1.8} [52] and assuming a volume expansion of 22% upon hydriding [76].

^g Reaction is associated with a sloping plateau with variable enthalpy and entropies of hydrogen desorption. Upon hydrogen cycling, the equilibrium pressure of this plateau increases to impractically high pressures.

also exhibit plateau slope and pressure hysteresis between absorption and desorption, both of which reduce performance in practical applications [55,56]. Despite this, a number of small- and large-scale systems have demonstrated their feasibility [11,55,57,58]. If efforts to reduce the cost of refining titanium metal from various ores can be realized [59–61], titanium-based intermetallic hydrides would become attractive materials for stationary hydrogen storage. More recently, complex metal hydrides that operate below 200 °C, such as NaAlH_4 and $\text{Mg}(\text{NH}_2)_2 + 2\text{LiH}$, have been investigated for the same purpose. These complex metal hydrides typically possess a gravimetric hydrogen capacity between ~2.5 and 6 wt.% H_2 (Table 1) and, in some cases, have the potential for reduced cost of the raw material [62]. However, the kinetics and thermodynamics of complex metal hydrides mean that they typically need to operate at 100 °C and above. The enthalpy of hydrogen absorption/desorption of complex hydrides compared to near-ambient intermetallics places greater demands on heat management of the hydride bed which increases the engineering cost of the hydride vessel and heat exchangers.

Table 1 shows the cost to store hydrogen for a low-cost titanium based intermetallic, $\text{Ti}_{1.2}\text{Mn}_{1.8}$, compared to some low-cost complex hydride systems based on NaAlH_4 . This shows that the raw material costs, in US\$/kg of H_2 , for the NaAlH_4 -based systems are between 2.5 and 4.5 times lower than the $\text{Ti}_{1.2}\text{Mn}_{1.8}$. While the cost of a hydride raw material is obviously an important factor in determining its feasibility for a particular application, additional factors that affect the associated engineering costs are also important. These include the practical gravimetric hydrogen capacity, the practical volumetric capacity, the enthalpy of hydrogen absorption/desorption and the kinetics of hydrogen absorption/desorption [53]. Both intermetallic and complex hydrides typically have practical gravimetric hydrogen capacities that are between ~80 and 90% of their theoretical values and, when mixed with expanded natural graphite (ENG), can be compacted into pellets with comparable thermal conductivities and densities that are between ~70 and 85% of their respective crystalline densities [63,64]. This means that practical volumetric hydrogen capacities are typically between ~55 and ~75% of the theoretical values and, despite the fact that complex hydrides have higher gravimetric hydrogen capacities, the high density of intermetallic hydrides means that their volumetric hydrogen capacities exceed those of complex hydrides by a percentage between ~30 and ~140%, as seen in Table 1. When considering the commercially available Hydralloy C5, the volumetric advantage of intermetallic hydrides is further enhanced considering that the enthalpy of hydrogen absorption for this alloy is at least 65% less exothermic than for any of the complex metal hydrides. These two factors combined infer that, for intermetallic hydrides, the engineering costs associated with the hydride containment vessel and the heat exchangers would in general be appreciably less than for complex hydrides [65]. This means that, despite the difference in raw material cost and hydrogen capacity between intermetallic and complex hydrides, choosing the most cost-effective hydride for a particular application is not straight forward, as it would first appear.

Nuclear application of hydrides

An interesting application of hydrides is found in small research nuclear reactors, originally designed in a team headed by Edward Teller and Freeman Dyson and built originally by General Atomics (GA) in 1958 [77–79]. In these TRIGA (Training, Research, Isotopes, General Atomics) reactors the fuel and the moderator are contained in one fuel-moderator rod, which is composed of a zirconium-uranium hydride. A typical composition of such a rod is 91 wt% (weight percent) Zr, 8 wt% U with 20% ^{235}U enrichment and 1 wt% H. The neutrons are moderated by the hydrogen in the hydride. The moderation of the neutrons in the fuel rod itself implies an inherent safety of these reactors according to the warm neutron principle: If the temperature of the fuel rises for some reason, the temperature of the moderated neutrons raises immediately, i.e. their kinetic energy increases, then their fission ability (cross section) instantly decreases and the reactor shuts down. This feature allows for power bursts up to 22000 MW in TRIGA reactors, although their steady state operation is up to the tens MW region. GA has built 66 such reactors around the globe. Today other countries, e.g. China, design and build this kind of reactors [80].

Metal hydride hydrogen compressors

The advantages of a metal hydride compressor are the high purity of hydrogen released and the compression carried out with heat instead of work. Moreover, as mentioned above, there are no moving parts and the pressure is high only during operation but not when the compressor is switched off. In the following a lab scale compressor is presented, that allows to produce high pressure hydrogen on demand in the lab and refills automatically from the low-pressure hydrogen line when it is not used.

Many applications require high purity hydrogen at elevated pressures of up to 1000 bar. The most prominent example of high-pressure hydrogen storage application is certainly to be found in automotive applications. In fact, the storage of hydrogen in high-pressure cylinders (35 MPa for heavy-duty vehicles and 70 MPa for light-weight cars) seems to have become the standard method, such as in the latest Toyota Mirai [81]. Experimental results will also be shown to be conducive to the set-up of a compressor delivering pressures up to 1000 bar addressing the operational range of refueling pressure of those vehicles. Currently, there exist three main types of technologies to compress hydrogen: mechanical compressors, ionic liquid piston compressors and metal hydrides compressors. Mechanical compressors compress hydrogen with a piston – the so-called p-V work. The actual compression work ranges between the isothermal and adiabatic limits. However, maintaining high hydrogen purity with mechanical compressors is a challenge, mainly because of the lubrication and the abrasion of the piston. Ionic liquid compressors are based on an ionic liquid piston instead of a metal piston as in a piston-metal diaphragm compressor. It takes advantage of two properties of ionic liquids: their virtually non-measurable vapor pressures and large temperature window for the liquid phase in combination with the low solubility of some gases (e.g. hydrogen). This technology

allows a reduction in the total number of parts in a compressor and has been successfully applied to hydrogen fueling station for delivery pressures up to 700 bar [82]. Metal hydride hydrogen compressors appear to be a very promising alternative to the above-mentioned technologies for several reasons, as outlined above. First, the compression only uses thermal energy instead of mechanical energy. Thus, the compression exergetic efficiency might exceed that of a mechanical compressor [55]. Furthermore, the lack of moving parts ensures a silent and vibration less operation. The use of metal hydrides allows purifying the hydrogen and ensuring the delivery of ultra-pure (99.9999%) hydrogen [83]. Finally, metal hydrides compressors allow storing hydrogen at low pressure, offering a very safe buffer and increasing the flexibility of the overall system.

Concept of metal hydrides hydrogen compression

The concept of metal hydride based hydrogen compression is based on the thermodynamics of the system. It follows a 4-step process, shown schematically in Fig. 1. First, hydrogen is absorbed at a low pressure and low temperature and forms a hydride (e.g. $\text{LaNi}_5 + 3\text{H}_2 \rightarrow \text{LaNi}_5\text{H}_6$). Thereby, it generates the heat $\Delta Q_1 = T_1 \cdot \Delta S$. This can be approximated by using the standard entropy of formation ($\Delta S \approx \Delta S^0(\text{H}_2) = 130 \text{ J mol}^{-1}\text{K}^{-1}$) and corresponds to $38.74 \text{ kJ mol}^{-1}\text{H}_2$. This approximation yields reasonable results for moderate pressures (< 200 bar). In the second step, the hydride is heated up until the desired pressure is reached. The energy necessary to heat a solid element from T_1 to T_2 is approximated by $\Delta Q_2 = C_v \cdot (T_2 - T_1)$. In the case of LaNi_5H_6 , it is $\Delta Q_2 = 9,5 R \cdot (T_2 - T_1) = 78.98 \cdot (T_2 - T_1) \text{ J} \cdot \text{K}^{-1} \cdot \text{mol}^{-1}\text{H}_2$ [84]. The third step consists of the desorption of hydrogen at high pressure p_2 and high temperature T_2 . During that process, the system requires heat to compensate for the endothermic desorption. The amount of heat required during desorption, $\Delta Q_3 = T_2 \cdot \Delta S$, is typically similar to the amount of heat generated during absorption. Finally, the last step consists of the cooling of the system to the initial temperature T_1 . Thereby, the alloy releases the heat $\Delta Q_4 = 6 R \cdot (T_1 - T_2) = 49.9 \cdot (T_2 - T_1) \text{ J} \cdot \text{K}^{-1} \cdot \text{mol}^{-1}\text{H}_2$. The compression process therefore requires a total of $\Delta Q_2 + \Delta Q_3 = 9,5 R \cdot (T_2 - T_1) + T_2 \cdot \Delta S$. It

is noticed that the main part of the energy required by the metal hydride compressor is the heat to desorb the hydrogen, while the heat required to heat up the hydride is less than 10% of the overall energy consumption. The equilibrium pressure of the hydride is a function of the temperature according to the van't Hoff equation, as shown in Eq. (1). The van't Hoff plot for a typical metal hydrides alloy is shown in Fig. 1, right.

$$R \ln \left(\frac{p_1}{p_0} \right) = \frac{\Delta H}{T} + \Delta S \quad (1)$$

The hydrogen compression using metal hydrides is essentially a batch process. However, a continuous stream of compressed hydrogen can be reached by combining two or more systems in parallel, as demonstrated in Ref. [85]. Further fundamentals of the materials and systems for the thermally driven compression of hydrogen using metal hydrides were considered in earlier reviews by the authors [55,86].

In chemical and metallurgical industries where inexpensive low-pressure hydrogen is produced in large amounts while the sources of low-potential heat as steam at $T \leq 150^\circ\text{C}$ are available, MHCs (Metal Hydride Compressors) can be profitably used [55,86]. Industrial-scale prototypes characterized by H_2 discharge pressures up to 150–200 bar and productivities of several $\text{Nm}^3 \text{H}_2/\text{h}$ are available at HYSTORSYS AS, Norway [87] and University of the Western Cape, South Africa [88]. Special Design Engineering Bureau in Electrochemistry, Russia [89], University of Birmingham, U.K. [90], Hystore Technologies Ltd, Greece [91] and a team of researchers from USA funded by a DoE project also report developments in the field [92].

Another important application of the MHC concept is its use in the design of high-pressure Sieverts devices to characterize the thermodynamic and kinetic properties of high equilibrium pressure hydrides. As an example for this application, a high-pressure Sieverts device at Moscow University works at pressures up to 2500 bar. This special Sieverts device consists of a purification system, a high-pressure generator, a buffer and a sample holder. Two pressure transducers with upper limits of 250 bar and 3000 bar are used to record the drop and increase of hydrogen pressure upon absorption and desorption, respectively. The hydrogen supply is connected to

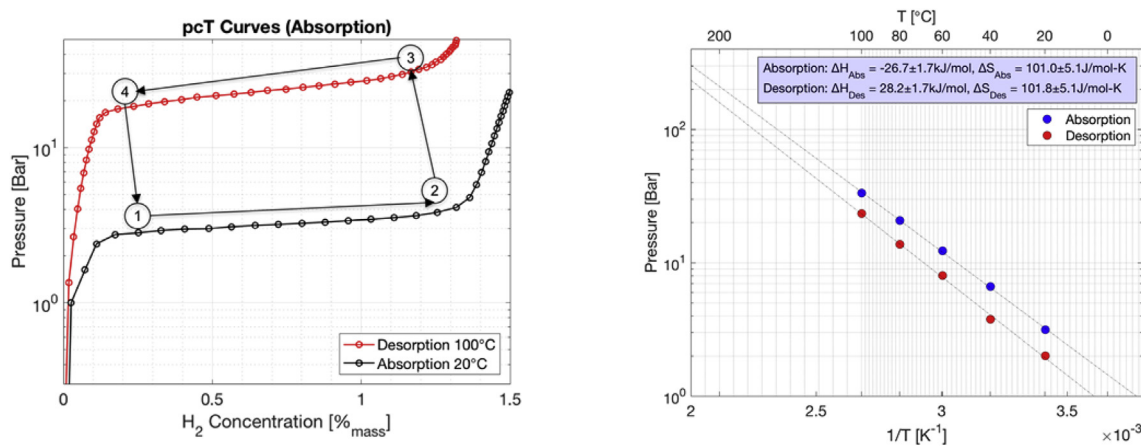

Fig. 1 – Working principles of the metal hydrides hydrogen compressor (left) and van't Hoff plot for a typical AB_5 alloy (from Ref. [85]).

the purification units composed of two vessels filled with AB₅-type alloy (LaNi₅) and AB₂-type alloy (Ti–Zr–C–Mn), preventing any contamination of the high-pressure generator. The high-pressure generator contains VH₂ to provide the required high pressure based on the MHC concept discussed above [93].

Modelling metal hydride compressors

As mentioned above, a metal hydride based solid-state compressor potentially offers significant advantages over mechanical compressor systems. In order to translate these advantages into commercially viable solid-state compressor systems there are key engineering challenges relating to heat management, material properties and system operation which must be addressed [86].

Impact of thermal performance

Generally, a key factor in the performance of all metal hydride applications is the thermal properties of the metal hydride, which include the thermal conductivity, enthalpy of reaction (as explained in detail above) and reaction kinetics. The majority of metal hydride empirical studies available in the literature have utilized relatively small amounts of storage material from which to generate data [94,95]. Although this is the most practical approach to the characterization of metal hydride candidates, it does not necessarily yield reliable insight into the actual performance of the larger scale systems that are being envisaged for commercial applications [13,19,96]. It cannot be assumed that as the size of a system is increased then the material properties that dominated the performance of small sample of material will also be the most dominant properties when the material is utilized on a larger scale. This has been shown to be the case with complex hydrides [97]. Using a numerical modelling, the variation in impact, that effective thermal conductivity, reaction enthalpy

and reaction kinetics has on the system performance, has been investigated by comparing two reactors containing an AB₅ alloy. Reactor (i) represents a typical size of sample system used for the characterization of metal hydrides, 0.2 g of metal powder, and reactor (ii) represents the scale of system required for a specific commercial thermal storage application, 30 kg of metal powder. The impacts of the mentioned parameters are explained in the following.

Effective thermal conductivity. A sensitivity study on the effective thermal conductivity using a numerical model indicated that small improvements in the thermal conductivity of the bed material would have significant effects on the store performance up to a value of ca. $1.5 \text{ Wm}^{-1}\text{K}^{-1}$. For example increasing the effective thermal conductivity, by the use of fillers or the incorporation of fins, from 0.1 to $1.2 \text{ Wm}^{-1}\text{K}^{-1}$ resulted in a significant decrease in the time it took for both reactors to reach 90% of their stored energy capacity and is illustrated in Fig. 2 left and right. There is an experimental and theoretical evidence that the achievable effective thermal conductivity of powdered metal hydrides is about $1\text{--}1.5 \text{ Wm}^{-1}\text{K}^{-1}$ [98], which in itself shows a promising path in future developments.

Although the same trend is observed for both reactors there is a much higher impact on the performance of the large scale system. Over the initial increases in effective thermal conductivity, from 0.1 to $1.2 \text{ Wm}^{-1}\text{K}^{-1}$, the small scale reactor increases the time to reach 90% of its thermal storage capacity by a factor of 1.7 (320 s reducing to 190 s), whereas for the large scale system the improvement in performance is increased by a factor of 5 (5.3 h reducing to 1 h).

Enthalpy of reaction. For metal hydride powders, there is the opportunity to tune the reaction enthalpy so that the equilibrium pressures of the material match the desired operating conditions of a specific application. In the case of metal

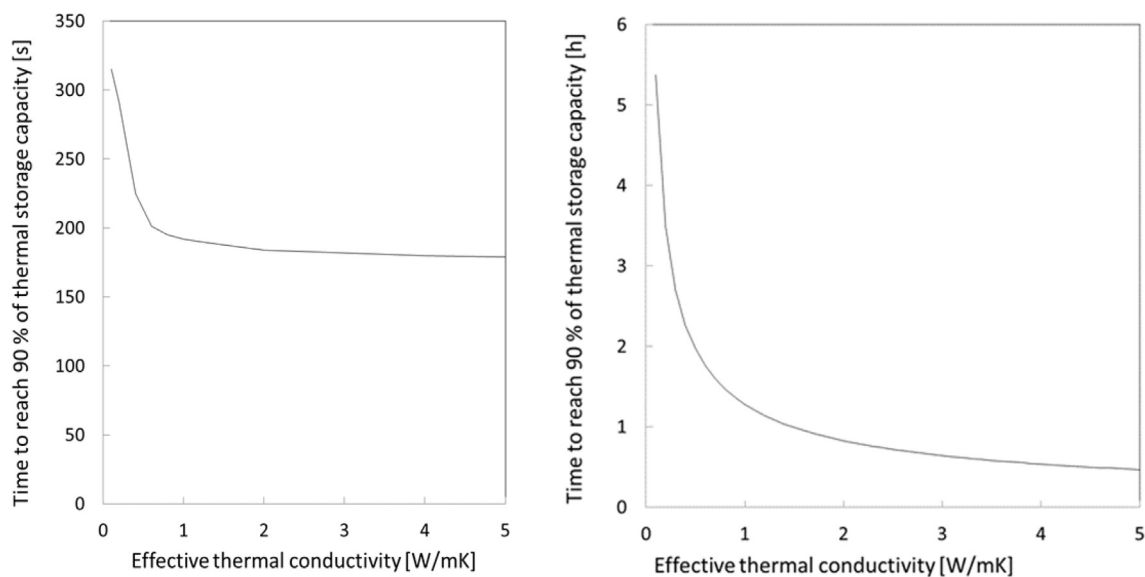

Fig. 2 – The impact on the system performance due to increases in effective thermal conductivity for 0.2 g (left) and 30 kg (right) of metal powder. Beyond an effective thermal conductivity of ca. $1.2 \text{ Wm}^{-1}\text{K}^{-1}$, only modest increases in system performance are obtained for comparatively large increases in effective thermal conductivity.

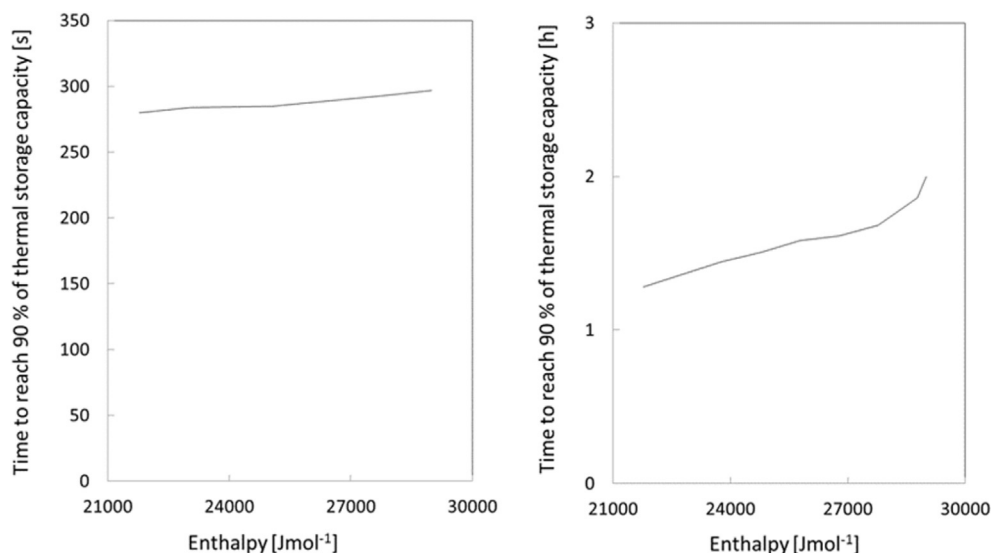

Fig. 3 – The impact on system performance due to increases reaction enthalpy for 0.2 g (left) and 30 kg (right) of metal powder. Increasing reaction enthalpy has a greater degree of impact on the larger system (b) than on the smaller system (a).

hydride compressors, this may allow a better match to be made between the available heat source and the resultant over pressure of the hydrogen gas. The reaction enthalpy also governs the thermal energy capacity of the storage system per kg of storage medium and so changes to the reaction enthalpy lead to changes in the system thermal capacity. Using the numerical model and assuming that changing the reaction enthalpy has no impact on the equilibrium pressure it can be seen that for reactor (i), changes in reaction enthalpy have a relatively small impact on the system performance, as can be seen in Fig. 3 (left). For reactor (ii), the large scale system, the same changes in reaction enthalpy result in much greater changes in system performance where the time taken to reach

90% thermal storage capacity increased by a factor of 2, as can be seen in Fig. 3(right).

Reaction kinetics. Finally, the impact of reaction kinetics on system performance was compared and for this study, it was imagined that incremental increases in the rate of reaction were achieved through staged enhancement of the kinetic properties of the material. It was found that a significant increase in the rate of reaction had a large impact on the system performance of reactor (i). In Fig. 4 (left) the time to reach 90% of thermal storage capacity is reduced by a factor of almost 3 through kinetic enhancement. In contrast applying the same enhancement to the kinetics of the large scale system, reactor

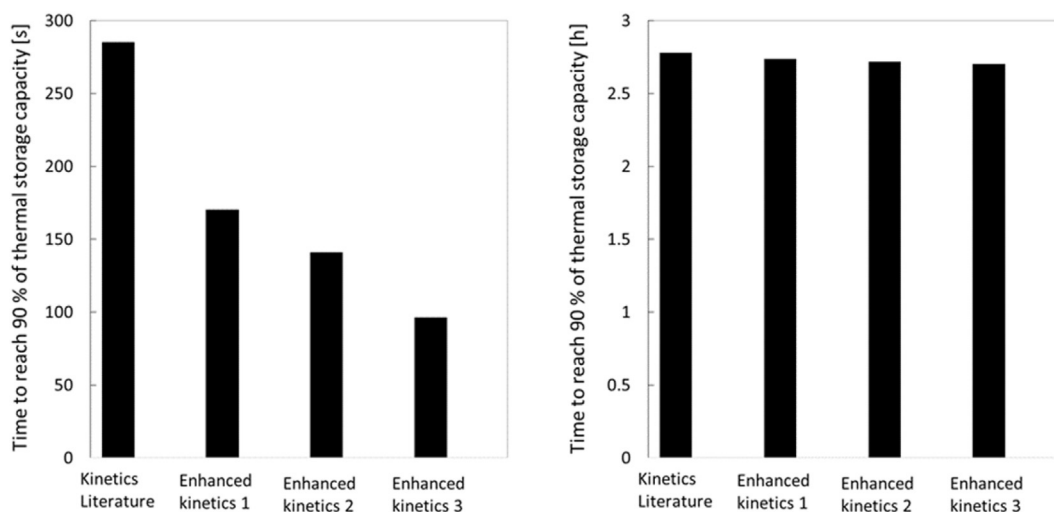

Fig. 4 – The impact on the system performance due to enhancement of reaction kinetics for 0.2 g (left) and 30 kg (right) of metal powder. Increasing the rate of reaction has a significantly greater impact on the smaller system (a) than on the larger system (b).

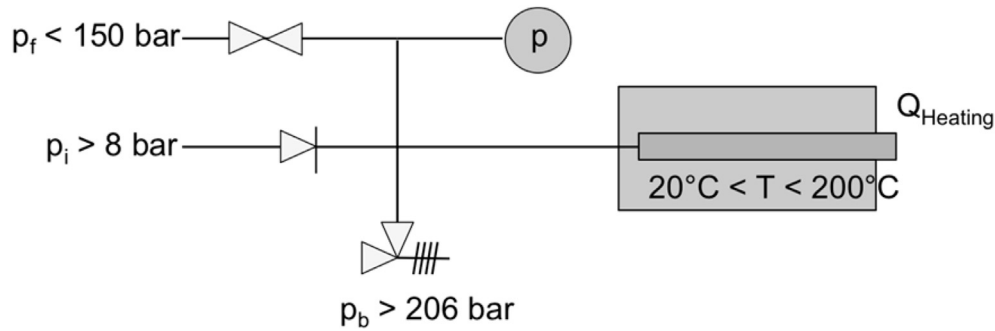

Fig. 5 – Schematic of the metal hydride compressor HyCo.

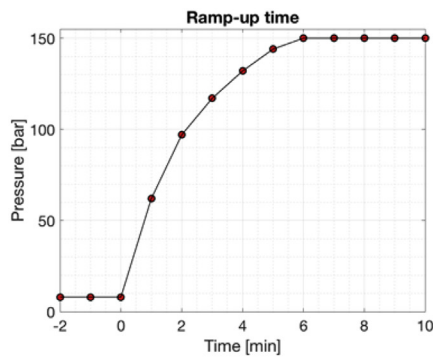

Fig. 6 – Ramp-up time (left) and picture of the actual system.

(ii), resulted in almost negligible improvement in system performance, as can be seen in Fig. 4(right).

It is evident that when optimizing both the design of the reactor and the properties of metal hydrides for use in solid-state compressor systems, that consideration must be given to the effect that scaling up has on the overall system performance. As demonstrated in the preceding numerical investigation, increasing the effective thermal conductivity and reaction enthalpy has a considerably greater impact on the performance of a large-scale system than it does on the small-scale system. Conversely, the impact that reaction kinetics have on the performance of a small-scale system is considerably greater than that of the large-scale system, confirming previous results [97]. For relatively large-scale systems, it must not be assumed that enhancements of certain material and thermal properties will deliver proportionate improvements in system performance.

Design of a lab-scale metal hydride compressor (MHC)

A metal hydride hydrogen compressor (HyCo) was developed for laboratory applications. The compressor absorbs hydrogen from a low-pressure source ($p_i < 8$ bar) such as an existing hydrogen line or a small-scale electrolyser. The metal hydride bed is then heated on demand until the required desorption pressure is reached (Fig. 5). The ramp-up time to reach the maximal pressure of 150 bar (200 optional) is less than 6 min, as shown in Fig. 6. A system of check valves ensures that the hydrogen flows in the right direction. A control system then maintains the pressure constant by adjusting the temperature of the system while hydrogen desorbs. Because of the phase transition occurring during desorption, the temperature remains nearly constant during that process. As the compressor is switched off, it cools down to room temperature and the pressure decreases below the pressure from the external source of hydrogen. Thus, the hydrides start to absorb hydrogen and the compressor gets refilled automatically.

The main characteristics of the HyCo MHC system are summarized in Table 2. A particular emphasis is laid on safety, with several passive elements such as pressure relief valve, thermal fuse and redundant sensors embedded in the system. The HyCo complies with the *Pressure Equipment Directive (PED) 2014/68/EU*. This system allows replacing high-pressure cylinders in the laboratory environment, thus increasing the safety level and facilitating the handling of hydrogen.

Table 2 – Main characteristics of the HyCo system.

Maximal Pressure [bar]	150 (200 optional)
Maximal Outlet Flow Rate [Nml/min]	400
Storage Capacity [Nl]	70
Refueling pressure [bar]	8
Ramp-up time [min]	6
Dimensions L x W x H [mm]	350 × 250 × 170

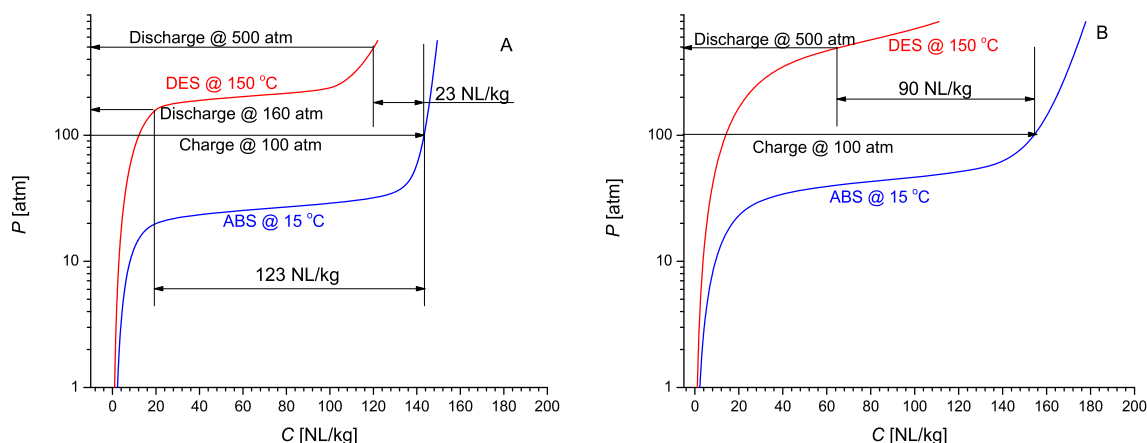

Fig. 7 – Simulated isotherms of H₂ absorption at T = 15 °C and H₂ desorption at T = 150 °C for La_{0.5}Ce_{0.5}Ni₅ (A; PCT data taken from Ref. [89]) and Ti_{0.7}Zr_{0.3}(Cr,Fe,Mn,Ni)₂ (B; PCT unpublished data from V. A. Yartys and M. Lototskyy).

This shows that metal hydrides hydrogen compression is an attractive method to pressurize hydrogen. As said before, also this system can work with waste heat, does not require any mechanical work, delivers highly pure hydrogen and allows storing the hydrogen at low pressure. This is an enormous advantage regarding safety. Finally, the operation is silent and does not cause any vibration – further increasing its usability in the laboratory environment. The laboratory compressor HyCo from GRZ technologies Ltd. is an ideal tool for the experiments that require high-pressure hydrogen. It avoids the installation of high-pressure cylinders in the laboratories. Furthermore, the MHC can be used as a safe source of hydrogen for beam lines in large experimental facilities like neutron sources and synchrotrons.

High discharge pressure metal hydride compressors

Development of MHCs providing high discharge pressures, exceeding 200 bar, which are in demand for the refueling of fuel cell powered utility vehicles and buses (above 400 bar), or passenger cars and unmanned aerial vehicles (above 700 bar), faces challenges from both MH material selection and engineering points of view. Although a successful application of MH for the generation of hydrogen pressures up to several kilobars has been demonstrated a long time ago [55], achieving a reasonably high compression productivities remains unsolved.

An upper limit of the cycle productivity of thermally driven hydrogen compression utilizing MH can be estimated from the analysis of the isotherms of hydrogen absorption in a MH material. A lower operating temperature, T_L , is applied during the cooling of the system and hydrogen desorption from the MH at a higher temperature, T_H , is applied during the heating of the hydride to achieve H₂ compression [55,86,88]. When correctly selected, the productivity of compression will be close to the reversible hydrogen sorption capacity and equal to the difference between hydrogen concentrations in the hydride phase at the temperatures and H₂ pressures corresponding to H₂ suction (absorption at $T = T_L$) and H₂ discharge (desorption at $T = T_H$) processes, as illustrated in Fig. 7.

Two selected examples of intermetallic alloys show the performance of metal hydride materials having enthalpy of desorption around 20–25 kJ/mol H₂ and working in a temperature window $T_L = 15\text{ °C} \leftrightarrow T_H = 150\text{ °C}$. This allows to reach a compression from 100 to 500 bar H₂. The chosen systems are La_{0.5}Ce_{0.5}Ni₅ studied in Ref. [89] and Ti_{0.7}Zr_{0.3}(Cr,Fe,Mn,Ni)₂ (unpublished data by V. A. Yartys and M. Lototskyy) as example systems. The values of ΔH for these hydrides are indeed within the mentioned range of enthalpies of formation/decomposition; for Ti_{0.7}Zr_{0.3}(Cr,Fe,Mn,Ni)₂ based hydride ΔH equals to -23.03 kJ/mol H_2 (see Table 1) while for La_{0.5}Ce_{0.5}Ni₅ the corresponding value is -25.55 kJ/mol H_2 [89]. From comparison of Fig. 7A and B, it can be seen that metal hydride H₂ compression shows a reasonably high productivity only when the selected H₂ discharge pressure is below or at the plateau pressure of hydrogen desorption at $T = T_H$. In contrast, when the discharge pressure exceeds the equilibrium pressure, the cycle productivity dramatically drops to unpractically low values.

Indeed, for La_{0.5}Ce_{0.5}Ni₅ desorption at 500 bar H₂/150 °C results in a release of only 23 NL H₂/1 kg of the alloy (see Fig. 7A). Such low productivity is because the desorption pressure is located above the plateau pressure. In contrast, for Ti_{0.7}Zr_{0.3}(Cr,Fe,Mn,Ni)₂ where the equilibrium desorption pressure is much higher, desorption at 500 bar H₂ results in 4 times higher productivity, 90 NL H₂/kg (Fig. 7B)

When considering H₂ compression to high hydrogen pressures exceeding 500 bar at available convenient heating temperatures of $\leq 150\text{ °C}$, it can be seen that application of AB₅-type intermetallics, even for those containing high amounts of cerium¹ results in a very low H₂ compression cycle productivity. Only 16% of hydrogen absorption capacity of the alloy charged at $T_L = 15\text{ °C}$ and $p_{H_2} = 100\text{ bar}$ (Fig. 7A). Further destabilization of the AB₅-based hydrides by increasing cerium content is not a viable approach because of a significant increase in hysteresis resulting in the decrease of the

¹ Cerium is known to reduce stability of the formed hydride and to increase stability of the intermetallic alloy during prolonged cycling (Tarasov et al. [89]).

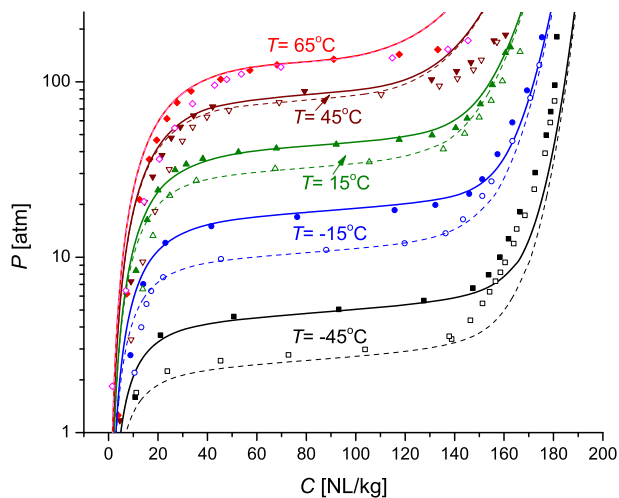

Fig. 8 – Experimental (points) and calculated (lines) isotherms (solid lines/filled symbols for H absorption; dashed lines/empty symbols for H desorption) for C14– $\text{Ti}_{0.7}\text{Zr}_{0.3}(\text{Cr,Fe,Mn,Ni})_2$ (V. Yartys and M. Lototskyy, unpublished data). Parameters of the calculated isotherms listed in Table 3 were obtained by the fitting of the experimental data using model [100].

compression ratio (i.e. higher suction pressures will be needed to achieve the target discharge pressure). Furthermore, this disadvantage is accompanied by another drawback, which is in increased energy consumption required to achieve H_2 compression [55,89].

As is well-known, C14- AB_2 type intermetallics are characterized by a broad range of hydride stabilities, low hysteresis and good cycle stability. Thus, they are most suitable to be used for the high-pressure hydrogen compression and are frequently utilized in the MHC with H_2 delivery pressure

≥ 200 bar [55,86–88]. Quite frequently, the AB_2 -type intermetallics for hydrogen compression are multicomponent alloys comprising of Ti and Zr from A side and Cr, Mn, Fe, Ni and V from B-side. The stability of the AB_2 -based hydrides can be decreased by increasing the Ti:Zr ratio, in parallel with an increase in the content of Fe and Ni, and decrease in the content of V in the alloy. The ratio of the B components, first of all, Cr:Mn:V, also determines the PCT properties, including maximum hydrogen sorption capacity, plateau slope and hysteresis of hydrogen absorption and desorption [90,99]. Thus, selection of appropriate compositions of the AB_2 alloys for hydrogen compression is a difficult task requiring optimization of their composition.

Fig. 8 and Table 3 present experimental data and modelling results [100] describing PCT properties of a multicomponent $\text{Ti}_{0.7}\text{Zr}_{0.3}(\text{Cr,Fe,Mn,Ni})_2$ alloy used in the studies of high pressure H_2 metal hydride compression which were carried out at IFE (Norway) and UWC (South Africa).

Fig. 7B shows that by applying this particular AB_2 -type alloy, it is possible to achieve reasonable cycle productivity (~60% of the H_2 absorption capacity) when compressing H_2 from 100 to 500 bar in the temperature range 15–150 °C. The productivity can be further increased by tailoring the alloy composition, first of all by increasing the critical temperature of the transformation α -solid solution – β -hydride, thus allowing to reduce a residual hydrogen concentration when desorbing high pressure H_2 .

Increase of the reversible hydrogen sorption capacity at the pressure/temperature conditions applied in the H_2 compression process will allow to increase the cycle productivity and is the most important target in the development of the MH materials for the high pressure H_2 compression. Improvement of activation performance and tolerance to the poisoning by gas impurities in H_2 should be also addressed as important operational parameters.

Table 3 – PCT fitting parameters for H– $\text{Ti}_{0.7}\text{Zr}_{0.3}(\text{Cr,Fe,Mn,Ni})_2$ system.

Parameter [units]		Value	Error ^a
Asymptotic H concentration, C_{\max} [NL/kg]		225.6	0.6
Critical temperature, T_c [K]		348.0	0.9
Entropy change for the hydride formation, ΔS [J/(mol H_2 K)]		–108.96	0.06
Enthalpy change for the hydride formation, ΔH [kJ/mol H_2]		–23.03	0.02
Hysteresis energy loss, ΔG_h [J/mol]		1198	22
Distribution parameters: H desorption	Width parameter, w_D [–]	0.156	0.008
	Contribution of Lorentz profile, η_D [–]	0.76	0.03
	Asymmetry, A_D [–]	–1	1
	Slope factor, s_D [–] ¹	1	–
Distribution parameters: H absorption	Width parameter, w_A [–]	0.175	0.009
	Contribution of Lorentz profile, η_A [–]	0.75	0.03
	Asymmetry, A_A [–]	–1	1
	Slope factor, s_A [–] ^b	1	–
Temperature dependence of the distribution parameters	Mixing coefficient, M [–]	0.1	0.1
	Temperature corresponding to the minimum plateau slope, T_0 [K]	380	140
	Pearson correlation coefficient, ρ_{SH} [–]	0.96	0.04

^a According to the modelling procedure [100], errors of the refined fitting parameters were assumed to be equal to their increments or decrements resulting in ~1% increase of the sum of squared distances of the experimental points from the calculated curves plotted in C/C_{\max} – $\ln P$ coordinates.

^b Not refined.

Further to the appropriate materials selection, efficient hydrogen compression requires proper addressing of the engineering problems. The main problem becomes critical when increasing the discharge pressure of the MHC to ≥ 400 –500 bar. Such compression will be much more efficient when reducing the dead space of a MH container for H_2 compression and gas distribution lines, as well as when decreasing the materials heat capacity by reduction of the weight of the MH container. This will obviously minimize the heat losses during its periodic heating and cooling without compromising a safe operation.

In line with the goal to decrease heat capacity of the MH compression system, recently UWC has developed a prototype composite MH container (carbon fiber wound stainless steel liner which comprises a MH cartridge) specially designed for the conditions of hydrogen compression applications (in collaboration with TF Design (Pty) Ltd (South Africa)). The features of the container include burst pressure >1850 bar, test pressure 650 bar, further to the high stability of the fiber winding against delamination during the pressure – temperature cycling.

Performed tests of the container (see Fig. 9) when using steam at temperatures up to $150\text{ }^\circ\text{C}$ showed a feasibility of its application for hydrogen compression to reach a pressure of 500 bar. This maximum pressure can be achieved in less than 10 min after the start of the heating with steam. The MH cartridge contains 1.8 kg of the AB_2 -type material described above which provides about 270–290 NL H_2 of full hydrogen sorption capacity and gives 100–150 NL H_2 released at a pressure of 500 bar.

Finally, the task of further increasing the output pressure of the MH compressor from 500 to 700–800 bar will be more challenging. At these higher pressures and temperatures of around $150\text{ }^\circ\text{C}$ a degradation of the intermetallics on cycling can be envisaged, particularly for the AB_5 type alloys. Therefore, an extra compression step would be required, increasing technical challenges in achieving the high pressure target goal. In conclusion, metal hydride compression has great advantages compared to other alternatives, however, it is a complex process with its efficiency determined by the degree of compression from P_{low} to P_{high} and the productivity of the process, defined as the amount of compressed hydrogen

provided to a supplier at a pressure P_{high} in kg H_2/h . In general, compression via metal hydrides requires several synchronized steps of compression. Additionally, not only the theoretical limits of the process determined by the ideal thermodynamics of the metal-hydrogen systems (van't Hoff Eq. (1)) need to be considered. Their nonideal behavior (hysteresis, slope of the isotherms, partial instead of complete reversibility of hydrogen absorption and desorption, etc.) need to be taken into account. Lastly, equally important effective kinetic parameters of the processes of hydrogen exchange performed in the dynamic conditions and heat transfer constraints determine the characteristics and, ultimately, the design of large-scale MH-based compressor systems.

Hydrogen storage for mobile applications

Mobile applications present a somewhat different spectrum of requirements from stationary ones, in that emphasis is put on characteristics of the hydrogen storage system that were not as important in the other cases. Most noticeably, while weight was of secondary importance, it requires increasing attention depending on the mode of transportation. Waterborne craft and railroad rolling stock are customarily counted among the heaviest transportation machines developed by humankind. The largest ships displace upwards of 440000 tons, as in the case of the TI class supertankers [101]. Trains can transport up to 82000 metric tons, as in the case of the BHP Iron Ore [102]. Road-bound vehicles are usually much lighter (except in very few, selected cases, in which speed is then dramatically reduced, such as the Scheuerle SPMT which, using a special construction, can move weights above 15000 tonnes [103]). Airborne craft demand attention for every gram of weight added to them, no matter their size, but especially in the case of massive airplanes like the Antonov An-225 with its 640 metric tons gross weight [104]. From this impromptu comparison, it is evident that the change from waterborne to rail to road transportation implies a reduction for each step of an order of magnitude in the weight that can be carried around. The switch to airborne transportation, however, diminishes this weight by two full orders of magnitude. Correspondingly, applications in floating or underwater craft will be addressed first, followed by railroad and then road bound applications. There are no known applications at present of hydrides for hydrogen storage in airplanes as the main energy carrier.

Another consideration attached to the usage of hydrides in mobile applications is the engineering associated with the heat exchange between the hydride storage tank and the host system. While in stationary applications, the heat involved both in the charging and discharging of hydrogen can be managed by conventional heat exchangers and liquid heat transfer agents with heat sinks in the form of relatively large vessels, this is not possible in mobile applications. There, the inventory of heat exchange agents has to be kept to a minimum and the heat exchange apparatus should be as compact and efficient as possible, to avoid occupying payload volume and/or producing unwanted aerodynamic or hydrodynamic flow resistance. Moreover, the amount of time required for charging is a variable that, under normal circumstances, is relatively uncritical for stationary applications. It is, however,

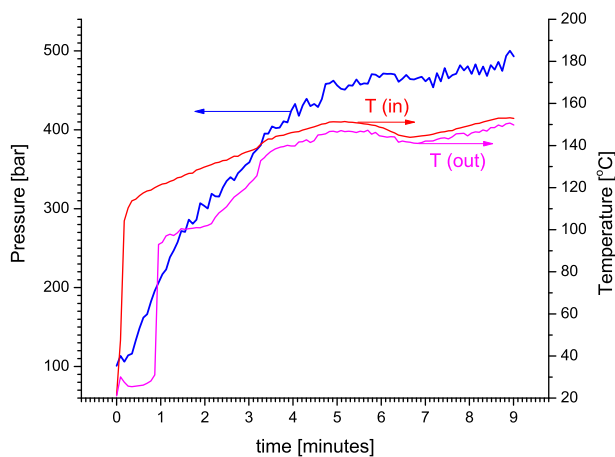

Fig. 9 – H_2 discharge during the heating by steam ($T = 150\text{ }^\circ\text{C}$) after the charge at $P(H_2) = 100$ bar at $T_L = 20\text{ }^\circ\text{C}$.

closely related to the heat exchange mentioned above. This is due to the fact that, for stationary applications, a charging hydrogen source is usually directly attached to the storage system, either in the form of an electrical grid (however small) plus electrolyser, or a reformer for some type of raw material such as natural gas, biogas or other hydrocarbons. This is not the case for mobile applications. By their very nature, such systems are usually away from a recharging point, which means that the craft needs to go on purpose to the charging point in order to refuel and continue its task. Therefore, recharging is a non-revenue generating activity, which should be kept as short as possible. This increases the requirements for the heat exchange systems that are necessary to dissipate the heat liberated by the hydride during charging; to the point that it could be said that they dominate the engineering of such storage systems, especially those for light duty road bound vehicles [105]. This is closely related to the heat storage considerations mentioned in the “Stationary Applications” section.

Underwater and waterborne applications

An underwater application is the largest-scale one for metal hydrides used for hydrogen storage in conjunction with a fuel cell in a mobile application to date: it is the type 212A submarine and its larger derivative, the type 214 [106–111]. The system is also installed in the Dolphin class and available as a so-called “plug” to be inserted abaft the conning tower (or sail) as a refit for older submarines, for instance the Type 209 [111]. In all these submarines, an expansion of capabilities for conventional, diesel-electric powered submarines such as had not been known since the 30s and 40s with the Walter hydrogen peroxide system [112] has been achieved. Indeed, for a generic vessel of about 3000 tons displacement, a nominal 100 MWh is deemed enough to yield the desired benefits using a PEM fuel cell of 600 kW [113]: the underwater range is increased by a factor of almost five in comparison with a single battery charge; the maximum submerged endurance rises to about 14 days. The detectability of the submarine is lowered because, at lower speeds, it does not need to snorkel, while at higher speeds than those allowed by the fuel cell on its own, the range is increased by judiciously coupling together the fuel cell and the battery.

The storage of hydrogen has been, until now, by way of room temperature metal hydrides, because analysis of the conditions on board disqualified other hydrides with higher capacities (or those which can be hydrolyzed) [114,115]. The result of a comparison cannot be in doubt when the criteria to evaluate the hydrides include at least 120 g/liter for the volumetric capacity and, most importantly, an operating temperature between 20 and 50 °C [114]. The storage cylinders for the hydride are located on the outside of the pressure hull, aligned with it and mainly on the lower part of the submarine, to avoid destabilizing it, since their weight is considerable. This arrangement is hardly new, since already the Type XXIX K1, developed in 1944, showed a similar placement, this time for the oxygen cylinders to be used in a closed-loop diesel propulsion scheme [116]. However, the quest for even higher performance in subsequent models has turned the attention towards onboard reforming of hydrocarbons as a source of

hydrogen [117]. Since in this case, operating temperatures of between 250 and 300 °C for the reformer seem to be acceptable, it might be of interest to evaluate high temperature hydrides such as MgH_2 for this application again. The most convincing argument would be, besides the higher gravimetric capacity, the fact that such hydrides still do not need oxygen or water to generate hydrogen, as opposed to the reforming of methanol (the fuel of choice in the reference mentioned above). Since the amount of oxygen that can be transported in the submarine is obviously limited, a new comparison, especially including the use of high-temperature fuel cells might change the whole outlook of these systems. It should not be overlooked that reformer systems require an exhaust of the CO_2 (and other reforming products) to the outside. At depth, this requires the compression of this stream to around 30 bars if operating at 300 m, for instance. At shallow depths, such as those encountered in coastal waters, the exhaust may even be detectable, either visually or chemically. This is the reason for including a specific piece of machinery to dissolve the gaseous exhaust in water prior to pumping the mixture outside of the submarine. This is an additional factor in the overall weight and volume needed by the energy storage system of the vessel. Elimination of these ancillary systems in favour of a larger amount of stored hydrogen using advanced hydrides could lead to a system with improved performance in comparison with the more conventional methanol reforming technology. An even greater change would be the combination of high and low temperature hydride and fuel cell systems for different operational regimes. For instance, a high temperature hydride combined with a medium-sized modular SOFC could provide power during transit to the operational area at speeds up to around 10 knots. A part of the power plant could be then shut down for slow patrolling, which requires little power as demonstrated by the extant PEM technology in the Type 212A. Since this high temperature system is relatively unresponsive, it should be used as a sort of baseload power plant. An additional low temperature, quick-reaction hydride system with PEM fuel cells of relatively high power could be used for combat situations, in which sudden spurts of high speed are needed for attack or evade manoeuvres. Moreover, the tried-and-true “sprint and drift” operation as practiced by the US Navy could, within limits, be used by such future advanced submarines.

It is not only in the realm of military applications that underwater craft have benefitted from the use of metal hydrides for hydrogen storage. Civilian-used submarines, especially the so-called AUVs (Autonomous Underwater Vehicles) have also made use of them, especially in the case of larger craft [118] for which higher endurances are desired. Undoubtedly, the constellation of hydrogen storage compactness together with a relative disregard for weight considerations (due to the fact that underwater craft need larger amounts of ballast to keep submerged and compensate for the buoyancy of the low-density payload spaces), together with their relative insensibility to temperature changes make the room temperature hydrides an attractive proposition [119].

Metal hydrides have proven to be also not only useful, but extremely long lasting in a fluvial environment: the “Ross

Barlow” canal boat, for instance, has performed admirably [120] and is expected to be able to operate for up to 100 years.

Railroad applications

The fact that metal hydrides have proven so effective in the marine environment suggests that usage of hydrides for hydrogen storage in other applications, in which space is at a premium, but weight is a secondary concern, could be equally successful. Such an application is railroads. Here, large amounts of energy need to be supplied to the traction engines for long periods of time when the lines are not electrified. Actually, the usage of hydrogen in railroads, independently of whether the hydrogen is stored in hydrides or not, has been championed since 2004 under the generic term of *hydrail* [121]. Although the advantages of hydrogen in general seem quite obvious [122], the large investments associated to developing new rolling stock, as well as a non-existent supply chain for hydrogen in the necessary amounts have slowed down the deployment of the technology. Until recently, a lot of the work was of a theoretical nature [123,124] or at the scale of prototypes [125,126]. However, the technology seems to be picking up momentum, both in China (CSR Sifang) and in Europe in the form of the much-publicized Coradia iLint [127].

Focusing on the narrower topic of hydride stores in trains, some smaller scale applications have been developed or studied [128–130]; larger scale systems are more scarce [131] but have shown good results, especially regarding cooling during the hydride loading process. Using a large water tank as a heat sink, a cooling rate of 2 MW was achieved in the system by Vehicle Projects LLC in Denver, CO. This allowed a charging time of around 30 min, which is extremely good for such an application: the tank was comprised of 213 kg of Hydralloy C15 (Table 1). The bed gravimetric capacity was 1.4 wt %. It stored 3 kg of hydrogen dispensed at 2–3 bar for a continuous operation of 8 h at the average power of 6 kW. Peak power was 17 kW. It could pull 4 tons of ore-loaded wagons [132]. It seems that the advantages of hydrides for hydrogen storage, as opposed to compressed gas, are compactness, simplicity, low-pressure operation and usage of the relatively high specific weight of the materials to lower the centre of gravity of the vehicles. Especially the low pressure requirements of metal hydrides and their ability to operate for extended periods of time without hydrogen emissions offer an improvement in safety that cannot be ascribed to other hydrogen technologies. Liquid hydrogen tends to be a technique to be used for shorter spans of storage time, since boil-off is always to be considered [133]. Ideally, a use for the boil-off gas should be found. The achievement of zero boil-off tanks has been investigated [134], but is still not a reality, except maybe for niche applications in the aerospace arena [135]. Pressure tanks are, by definition, forced to operate at high pressures, which require safety measures to avoid an explosive release of hydrogen. While pressure vessel explosions are extremely dangerous, no matter which gas is stored in the vessel, hydrogen adds the flammability hazard. The spontaneous ignition of released hydrogen has been studied [136] and shown to be a risk with a direct relationship to the pressure of the vessel releasing the gas [137–142]. This fact alone speaks for the

usage of hydrides whenever a release of gas is especially to be avoided. This is the case for underground rolling stock, since a release of hydrogen in the confined spaces of an underground mine would be devastating. For this specific use, railway systems have been developed, as shown in the example above, that have shown the feasibility of the concept [132,143,144].

Road bound applications

Heavy duty utility vehicle applications

Similar to waterborne applications, where the low gravimetric hydrogen storage capacity/high weight of (inter)metallic hydrides can bring benefits in stabilizing a vessel without carrying additional ballast [145], another important application of H₂ storage and supply systems based on materials with low gravimetric H₂ storage densities is in heavy-duty hydrogen-driven utility vehicles. One successful application is a metal hydride based hydrogen fuel cell forklift which, during its operation, requires the use of a significant weight counterbalance and, at the same time, meets strict space constraints. These constraints determined the success of the fuel cell power module and hydrogen storage system [11,146]. A successful integration of metal hydride hydrogen storage in electric forklift (STILL, GmbH) equipped with fuel cell power module (Plug Power, Inc.) has been demonstrated by HySA Systems Competence Centre in South Africa [147,148] (see Fig. 10).

The forklift (1) utilizes a hybrid (hydrogen fuel cell + battery) power module (2) where the fuel cell is integrated with the MH hydrogen storage system. The H₂ store of the forklift is recharged at the hydrogen refueling system (3) consisting of a low-pressure H₂ supply line and a MH hydrogen compressor used during periodic refueling of the on-board hydrogen storage system of the power module (2).

The “distributed hybrid” hydrogen storage system is described in Ref. [149] and consists of a compact MH hydrogen storage unit with twenty stainless steel containers (ø51.3 × 800 mm each) filled with Ti_{0.65}Zr_{0.35}(Fe, Cr, Mn, Ni)₂ hydrogen storage alloy immersed in a water tank (950 × 120 × 700 mm). In addition, the MH hydrogen storage unit contains a 74.2 L composite cylinder filled with compressed H₂. The power module and the MH unit are placed in the battery compartment of the standard forklift as shown in Fig. 10 (bottom right). Both the forklift and the refueling station have been in operation at Impala Platinum Refineries in South Africa since October 2015. During the 3 years of continuous operation in an industrial environment, both MH-based systems demonstrated excellent performance, meeting the demands from the industrial customer. During operation, hydrogen refueling of the forklift (at dispensing pressures of 150–185 bar) takes no longer than 15 min. The 15 min refueling cycle yields a useable hydrogen storage capacity (MH

² For the standard battery powered version 4 h.

³ Total mass of the commercial power module 1560 kg; with the MH tank and holding pallet 1850 kg; safety limits for the forklift 1800–2000 kg.

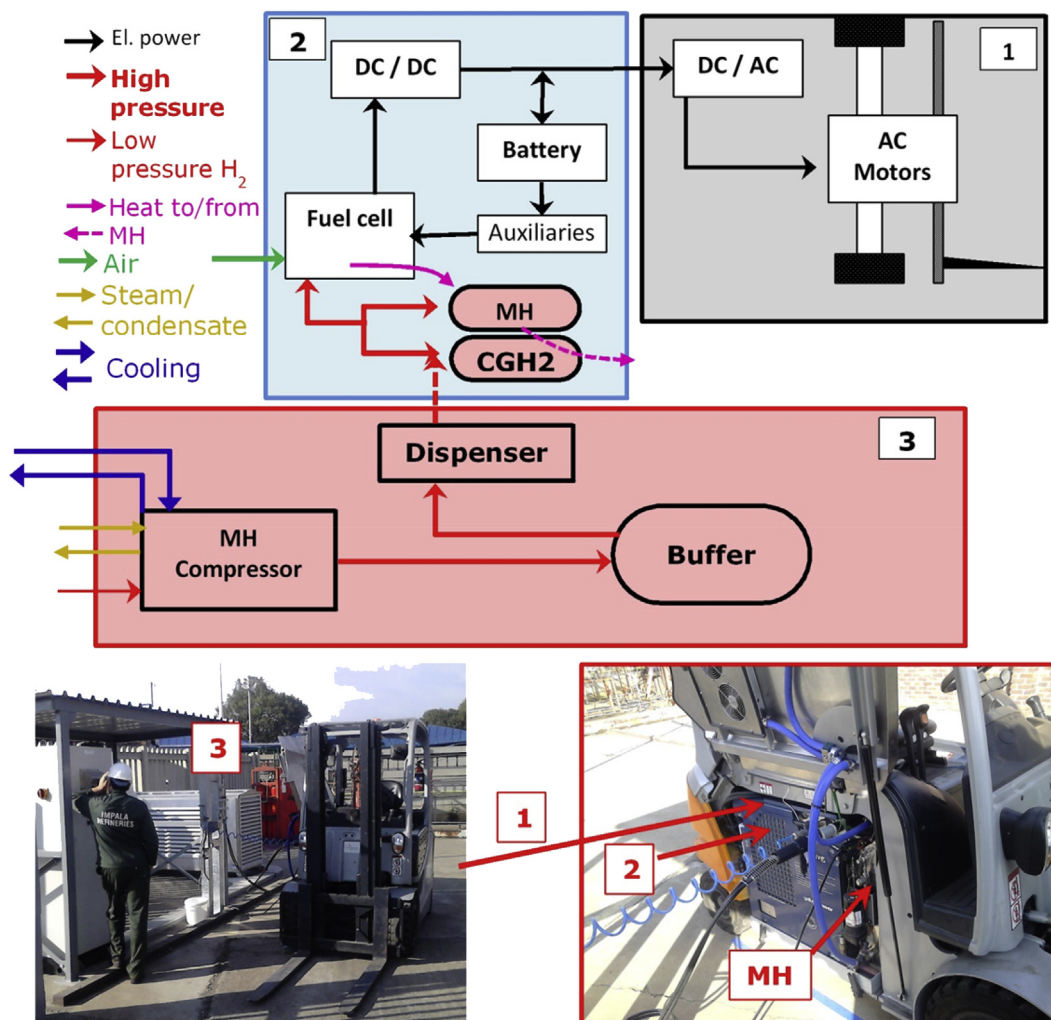

Fig. 10 – Top: general system concept, bottom: prototypes of FC/MH forklift and MH based H₂ refueling station (Implats refineries, South Africa). 1 – forklift, 2 – fuel cell power module with integrated H₂ storage, 3 – refueling system. Technical characteristics: full-load (VDI-60) operation time 3.1 h², average power 10 kW. Mass of the MH system 250 kg³. Useable H₂ capacity 1.83 kg. Hydrogen charging pressure 185 bar. Charging time 6–15 min.

system + compressed H₂) of about 1.83 kg H₂. This is 8% higher than the usable capacity of the standard compressed H₂ tank in the commercial power module (1.69 kg H₂) at the standard refueling pressure of 350 bar. Shortening the refueling time to just 6 min allows recharging of 1.52 kg of H₂, which exceeds 80% of the maximum usable hydrogen storage capacity of the forklift system.

Hydrogen refueling (system 3 in Fig. 10) is provided by a thermally driven hydrogen compressor, which utilizes low pressure H₂ (below 50 bar) produced at a customer site. It compresses the hydrogen to a high pressure (200 bar), at which it is stored in a buffer tank (standard gas cylinder pack). Later, during the operation cycle, hydrogen is dispensed to the H₂ storage system of the vehicle where it is used at operating pressures between 150 and 190 bar H₂. The advantage of using such type of system is that these pressures are significantly lower than the ≥ 350 bar dispensing pressure necessary for the refueling of the standard compressed H₂ system alone, making hydrogen storage more safe and less expensive. Another

advantage of using metal hydride hydrogen compression lies in the fact that it is thermally-driven, with heat supplied by the use of low-grade steam (120–140 °C). Cooling is achieved using circulating cooling water (15–25 °C); both are available at the site of the industrial customer and utilized “for free” without extra capital investments while saving the electrical energy that would otherwise be required for the process.

Light passenger vehicle applications

Hydrogen and fuel cells are internationally recognized as a long-term solution enabling the use of renewable energy for mobile applications providing zero particle emission and a carbon neutral transportation system [150]. Unfortunately, safe, energy- and cost-efficient compression, refueling and on-board storage of hydrogen allowing it to be the successor for gasoline are still lacking [151]. Hydrogen compression is today energy intensive, with insufficient capacity and expensive system components [152]. Secondly, no hydrogen

Table 4 – Properties of room temperature hydride forming materials for the “hybrid concept”. N.A.: Not available.

Materials	ΔH (kJ/mol H ₂)	P _{dehyd.} (bar) (-50 – 25 °C)	P _{hyd.} (bar) (-30 °C)	Gravimetric H ₂ capacity (wt.%)	Hyd./Dehyd. Times (seconds)	Cycling Stability Cycles/loss of capacity in %	Activation Required	Ref.
Ti _{0.5} V _{0.5} Mn ^a	-26.8	2–4 (-30)	60 (20)	1.8 ^d	–	–	Yes	[157]
Ti _{1.1} CrMn ^a	-22.0	2–6 (-40)	30–110 (23)	1.8	60/300 (23 °C)	1000/6%	N.A.	[158]
Ti ₃₅ Cr ₃₄ Mn ₃₁ ^{a,b}	N.A.	40 (25)	50 (25)	1.9 ^{a,d} /1.8 ^b	Hyd. 80% of max. capacity in 300 (25 °C) ^b	N.A.	Yes	[159]
Ti ₂₅ Cr ₅₀ V ₂₀ Mo ₅ ^{a,b}	N.A.	23 (25)	85 (25)	2.5 ^{a,d} /2.4 ^b	Hyd. 72% of max. capacity in 300 (25 °C) ^b	N.A.	Yes	[160]
TiCr _{1.9} Mo _{0.1} ^a	-24.8	8 (-50)	116.5 (20)	1.9 ^d	N.A.	N.A.	Yes	[160]
ZrFe _{1.8} V _{0.2} ^a	-23.6	2 (-30) ^c	15.7 (20)	1.8 ^d	N.A.	N.A.	Yes	[161]
ZrFe _{1.8} Mn _{0.2} ^a	-21.8	2 (-30) ^c	295 (20)	1.8 ^d	N.A.	N.A.	Yes	[161]
Zr _{0.2} Ti _{0.8} Fe _{1.6} V _{0.4} ^a	-19.7	3 (-30) ^c	172 (20)	1.8 ^d	N.A.	N.A.	Yes	[161]
ZrFe _{1.85} V _{0.20} ^c	-22.0	8.5 (-20)	32 (20) ^a	1.7 ^d	N.A.	N.A.	Yes	[162]
Ti _{0.32} Cr _{0.43} V _{0.25} ^a	N.A.	N.A.	0.1–10 (30)	3.3 ^d	N.A.	N.A.	N.A.	[162]
(Ti _{0.85} Zr _{0.15}) ^a	23.7	2.7 (-30)	N.A.	1.8	-/120 (30 °C)	50/0%	Yes	[163]
1.1Cr _{0.9} Mo _{0.1} Mn ^a								
(Ti _{0.85} Zr _{0.15}) ^a	25.4	2.7 (-30)	N.A.	1.6	-/120 (25 °C)	50/0%	Yes	[164]
1.1Cr _{0.925} MnFe _{0.075} ^a								
Ti _{1.02} Cr _{1.1} Mn _{0.3} Fe _{0.6} ^a	17.8	5.5 (-30)	N.A.	1.7 ^a	N.A.	N.A.	Yes	[165]

^a Laboratory scale.

^b Large scale.

^c Calculated from the thermodynamic parameters.

^d From PCI.

storage method has yet been identified that fulfils all the requirements for mobile applications neither in the gas- (high pressure), liquid- (cryogenic) or solid-state. It is still a challenge to find a suitable hydrogen reservoir for the environmentally friendly fuel cell powered vehicles, or at least to reach an optimum trade-off between the requirements for vehicle usage and the characteristics and natural limitations of a hydrogen storage system. In this regard, the cruising range of vehicles is constrained by the amount of hydrogen on-board, since hydrogen has just one tenth of the energy as compared to gasoline in the same volume. In terms of efficiency and safety, it is preferable to keep gaseous hydrogen under low pressure. However, it is not possible to store enough hydrogen under low pressure in vehicles to achieve meaningful driving ranges. Therefore, it is imperative to compress hydrogen gas or to make it absorb into a solid material to increase its density. Neither compressed hydrogen gas technology under 700 bar nor solid-state hydrogen storage systems fulfil all of the demanding requirements in terms of safety, efficiency and cost for vehicular applications [153,154]. In the following, the hybrid solid-state/pressurized gas concept will be presented and then the results of research projects showing promising results with innovative hydrides will be introduced.

Hybrid pressure-hydride hydrogen storage technology for vehicular applications

For on-board hydrogen storage on fuel cell vehicles (FCV), the combination of metal hydrides and 350 bar pressure vessels has been proposed as a realistic solution. This concept is known as “hybrid hydrogen storage vessel” [155,156]. The hydride forming material suitable for this kind of application should have the following properties: (1) hydrogen weight capacity over 3 wt.%, (2) low heat of formation of about 20 kJ/mol, (3) high desorption equilibrium pressure over 10 bar at -30 °C, (4) absorption equilibrium pressure lower than 350 bar at 120 °C and (5) good cycling stability with less than 10% of capacity loss after 1000 cycles [157]. Special efforts were put into designing suitable room temperature hydrides owing to their high volumetric hydrogen capacity. In this regard, high equilibrium pressure Ti–Cr–, Ti–Mn– and Zr–Fe-based alloys (AB₂ alloys, BCC and Laves phase hydrides) were prepared by arc melting and their crystal structures, morphology and thermodynamic and kinetic properties have been studied. The hydrogen capacity and equilibrium pressures of these hydride forming materials can be tuned by changing their compositions and by substituting their main components for metals such as Mo, V, Zr, Mn and Fe, among others [157–165]. The equilibrium pressure (p_{eq}) values of room temperature hydrides depend on the ratio between the bulk modulus (B) and the cell volume (V_o), $\ln(p) \propto B/V_o$ [158]. Thus, for instance, the partial substitution of Ti for Cr or Mn in Ti–Cr–Mn alloy causes a decrease in the equilibrium pressure because the cell volume is increased by the larger size of Ti (metallic radii Ti: 0.147 nm, Cr: 0.119 nm and Mn: 0.118 nm) [158]. Substituting V for Mo in the Ti–Cr–V alloy increases the equilibrium pressure. V and Mo have similar sizes, keeping the same cell volume after the substitution. However, the bulk modulus of Mo (B: 230 GPa) is higher than the one for V (160 GPa) [161]. For the case of Ti–Cr–V alloy the hydrogen capacity can be tailored by

Table 5 – Relevant properties for low-pressure metal hydride, high pressure gas, hybrid (Ti–Cr–Mn and Ti–Cr–V–Mo) and the distributed hybrid hydrogen storage methods. N.A.: Not available.

	Low-pressure metal hydride tank [161]	High pressure gas tank [159,161]	Hybrid tank with Ti–Cr–Mn alloy [159,161]	Hybrid tank with Ti–Cr–V–Mo alloy [159]	Distributed hybrid system [149]
Operative pressure	<10 bar	350 bar	350 bar	350 bar	100 bar
Vessel(s) volume	120 L	180 L	180 L	180 L	~11 L - ~ 18 L ^a
Vessel(s) weight	300 kg	<100 kg	420 kg	420 kg	N.A. ^b
Hydrogen storage capacity	3.5 kg	3 kg	7.3 kg	8.5 kg	volumetric storage capacity similar to hybrid tank
Hydrogen filling time	0.5–1 h with extreme cooling facility	5–10 min	80% max. capacity in 5 min	72% max. capacity in 5 min	<20 min
Hydrogen released at low temperature	Not possible	Possible	Possible	Possible	Possible
Hydrogen supply control	Difficult in acceleration	Good	Good	Good	Good
Type of Vessel(s)	One stainless steel vessel	One reinforced vessel	N.A. (For on-board applications, reinforced tank required)	N.A. (For on-board applications, reinforced tank required)	One stainless steel vessel (~4 L Metal hydride) + One or two composite tanks (each 6.8 L, compressed hydrogen)

^a The system is composed of one or two gas compressed tanks, thus the volume ranges between ~ 11 L and ~ 18 L (this is just the volume of the tanks).

^b The total weight of the system is not available, just the weight of the AB₂-type alloy (12.17 kg) for the metal hydride tank is provided.

changing the Ti/Cr ratio. Table 1 summarizes the properties of some room temperature materials investigated for the hybrid concept. It is possible to observe that the hydride forming alloys do not fulfill all of the above mentioned requirements.

Corgnale et al. [166] performed a structural analysis of the different containers for hybrid hydrogen storage tanks. The structural analysis took into account different wall materials like stainless steel (SS316) and composite materials (GFREC: graphite fiber reinforced epoxy composite) in the range of pressure from 50 bar to 850 bar. On one hand, results for an optimized hydrogen gravimetric and volumetric capacity showed that, for the SS316 wall material, high gravimetric capacity hydrides under low pressure (50 bar) are convenient. On the other hand, for GFREC materials with low density and high allowable stresses, high pressures (350 bar) are more suitable, particularly when a low gravimetric capacity hydride (1–3 wt.%) is available.

Two hybrid concepts were proposed so far: (1) hybrid storage tanks, consisting of the hydride material and pressurized hydrogen gas in the same container and (2) distributed hybrid system, in which the hydride material and the pressurized hydrogen gas are in separate vessels [149,155,156,159]. Already there exist hybrid hydrogen storage tank prototypes containing Ti–Cr–Mn and Ti–Cr–V–Mo for an operative pressure of 350 bar [155,156,159]. Lototsky et al. [149] proposed a “distributed hybrid system” to be used for on-board low temperature fuel cells. This system consists of individual metal hydride tanks filled with a medium stability AB₂-type alloy coupled with a separate compressed gas tank.

Table 5 summarizes some relevant features for the different hydrogen storage methods, i.e. low-pressure metal hydride tank, high pressure gas tank, hybrid tank containing Ti–Cr–Mn and Ti–Cr–V–Mo as well as the distributed hybrid system. The hybrid concept profits from the reduction of hydrogen charge pressure in comparison with the 700 bar reinforced tanks. In the case of the low-pressure metal hydride tank, it has higher hydrogen storage density than the hybrid concept, but it has serious problems for hydrogen refueling, hydrogen release control and the availability of hydrogen at low temperature is not possible. In comparison with the 350 bar gas pressure tank, the hybrid concept benefits from higher storage capacities with the same hydrogen refueling, hydrogen released and control conditions. Furthermore, the hybrid concept provides flexibility to be adapted to a distributed system and fast response for the transient working conditions (acceleration or startup of the vehicle). In particular, the innovative distributed hydride system presents a hydrogen storage density similar to that of hybrid hydrogen storage tanks in one vessel, easier thermal management and lower hydrogen operative pressure (100 bar).

Despite all the advantageous technical aspects of the hybrid concept, there are still some issues to be solved. First, most of the hydride forming alloys have relatively low hydrogen gravimetric capacities and have relatively high costs for scaling up [167]. Second, it still demands the utilization of high cost composite materials for the wall of the tank, particularly for the 350 bar hybrid tanks. Finally, the utilization of 350 bar compressed gas causes high indirect costs associated with the use of expensive refueling infrastructure. Therefore, more work must be done to address the remaining

problems and to develop an improved hybrid system for a broad market application.

Research in advanced high capacity hydrides for vehicular applications

Research with the aim of introducing advanced high capacity hydrides (as opposed to the ones described above and suitable for the hybrid tank) in the private passenger vehicle power-train has been underway for some time. Several projects have been carried out in the past with this aim.

One of the most extensive efforts to investigate hydrogen usage in vehicular applications was the STORHY project (Hydrogen Storage Systems for Automotive Application) [168], funded by the Fuel Cells and Hydrogen Joint Undertaking, and carried out between 2004 and 2008. The participation of major automotive industry players (BMW, DaimlerChrysler, etc.) ensured that the information obtained during the project was relevant for the development of future passenger vehicles. In this project, not only hydrides, but all other forms of storage were studied in regard to their suitability for automotive applications.

In the frame of this project, as already said, solid-state storage in hydrides was compared to the other options (pressurized gaseous and liquid hydrogen). For this purpose, the largest sodium alanate tank developed in Europe was designed and built [169]. It could be shown that, according to specifications, it could be charged to 80% of its capacity in less than 10 min. Cycling (hydrogen charging and discharging) was also successful, increasing the gravimetric capacity of the material after the initial activation cycles to a value ≈ 4.5 wt. %. Until then, it had been in doubt that a hydride-based tank could display such fast kinetics, especially one using high-capacity complex hydrides, which were at the time less well-known than the “classical” metal hydrides that have been mentioned above in Table 4.

Another important project in the development of hydrides for automotive applications was NESSHY (Novel efficient solid storage for hydrogen) [170], also a European project financed by the Fuel Cells and Hydrogen Joint Undertaking. It was carried out between 2006 and 2010. The focus of this project, as its name indicates, was much more on hydrides than was the case with STORHY. Therefore, the application-oriented results were two tanks, one based on magnesium hydride [171] and the other one on sodium alanate [172]. The tank based on magnesium hydride was very much oriented towards stationary applications, since its high operational temperature (around 300 °C) and large reaction enthalpy of the material were not suitable for coupling with a vehicular fuel cell, not even a high temperature PEM one. Thus, there was no emphasis on light weight or compact shape and size. The alanate tank, on the other hand, was specifically designed to be lighter than its predecessor in project STORHY, and so take another hurdle towards vehicular use. The improvement in gravimetric capacity was 83% and the one in volumetric capacity was 49%. The amount of hydrogen stored was ~ 0.2 kg of hydrogen, half of the quantity stored in the STORHY tank. Fig. 11 shows a depiction of the alanate tank developed during the NESSHY project.

The goal for the project HyFillFast, “Fast, efficient and high capacity hydrogen refueling and on-board storage” (which

was carried out from 2012 to 2017 and funded by the Danish Research Council), was to conduct research within a new concept, which integrates compression of hydrogen using an ionic liquid as piston with combined solid state and high pressure on-board hydrogen storage. Ionic liquid gas compression has the potential to increase the capacity and energy efficiency by applying internal cooling during the compression process. Combined high pressure (700 bar) and solid-state hydrogen storage clearly has the potential to increase the storage capacity considerably. The great challenge is to engineer the storage tank with the pressure and temperature controlled chemical reactions and transformation in such a way that both hydrogen and heat is absorbed, thereby increasing both the energy efficiency and storage capacity [173]. The strategy is to have several materials in the storage tank, e.g. one or more that absorb hydrogen combined with phase change materials that absorb heat.

The maximum temperature allowed for a standard Type IV H₂ tank while refueling to 700 bar is 85 °C. Therefore, hydrogen is pre-cooled to $T = -40$ °C. Fuelling hydrogen gas at 20 °C to 700 bar would result in a 12% lower amount of H₂ in the storage tank. Results show that a paraffin wax layer of 10 mm can absorb enough heat to keep $T < 85$ °C, but its influence on the hydrogen peak temperature that occurs at the end of refueling is modest, because the heat transfer from the gas to the phase change material mainly occurs after the fuelling is completed [174].

A wide range of new hydrides, in particular boron and nitrogen based materials [175], were discovered in the project, but usually release and uptake of hydrogen occur at too high temperature [176]. Thermodynamic considerations reveal that a hydrogen storage material may exist, which can absorb both heat and hydrogen in case another gas is product of the rehydrogenation. A well-known example is the reaction of lithium amide and hydrogen, which forms ammonia and lithium hydride. However, that may introduce new challenges for storage tank design, which may need to include compartments.

The efforts within HyFillFast have inspired the industrial partner company NEL to further develop hydrogen fuelling technology so that refueling time and driving range is comparable to that of similar gasoline vehicles. Today NEL is the world's largest manufacturer of hydrogen production and fuelling equipment, with 200 employees in Europe and US [177].

Within the SSH2S project (Fuel Cell Coupled Solid State Hydrogen Storage Tank, which was carried out from 2011 to 2015 and funded by the European Union under the Fuel Cells and Hydrogen Joint Undertaking), a demonstration solid-state hydrogen tank, coupled with a High Temperature Proton Exchange Membrane (HT-PEM) to be used as Auxiliary Power Unit (APU) for a light duty vehicle, has been realized, following a more elaborated design [1,178]. In this case, the storage tank consists of three concentric tubes and the hydrogen carrier is based on a mixed lithium amide/magnesium hydride system, coupled with an intermetallic compound. In details, the inner tube is filled with LaNi_{4.3}Al_{0.4}Mn_{0.3}, while the middle one is filled with a mixture of 2LiNH₂+1.1MgH₂+0.1LiBH₄+3 wt.% ZrCoH₃. The thermal exchanger, adopting triethylene glycol as heat transfer medium, is performed in the outer tube. The



Fig. 11 – The sodium alanate-based hydrogen storage tank developed during the NESHY project showing the attachments to the testing rig.

system was planned to supply a 1 kW HT-PEM stack for 2 h. The combined hydrides used as hydrogen carriers have a gravimetric hydrogen storage density of 2.45 wt.% H₂. A full thermal integration was possible thanks to the high operation temperature of the fuel cell and to the relative low temperature (170 °C) for hydrogen release from the mixed lithium amide/magnesium hydride system. The development of the tank has been followed by a study involving a Life Cycle Assessment (LCA) [179]. It demonstrated that, when the electricity consumption for hydrogen gas compression is included into the analysis, a solid-state hydrogen storage tank has similar greenhouse gas emissions and primary energy demand than those of type III and IV gas tanks.

The challenge is to develop a container in which the right compromise is achieved, especially for mobile applications, among H₂ storage gravimetric and volumetric density, integrity of the containment at operative condition and dynamic performances of the gas [11]. As an example, the volumetric storage capacity of the SSH2S tank described above [178] is 10 kgH₂·m⁻³, to be compared with compressed hydrogen tanks, which ranges between 9 kgH₂·m⁻³ and 23 kgH₂·m⁻³ for steel cylinders at 200 bar and type IV composite cylinders at 700 bar [180]. On the other hand, liquid hydrogen based storage systems can reach a volumetric capacity of 40 kgH₂·m⁻³, but suffer from an extremely complex thermal management and from the continuous hydrogen boil-off [180].

In this paragraph, a simple approach is proposed, based on a series of simulations, to evaluate the influence of MH property (i.e. the gravimetric and volumetric capacity of the hydrogen carrier) and tank geometry (i.e. tube diameter) on the gravimetric and volumetric capacity of a hydrogen storage system. Thus, simulations do not take into account the kinetic

and thermo-fluid dynamic of the entire systems, since the aim here is to evaluate the gravimetric and volumetric capacity of the system in relation with the ones of MHs and to material and geometry of the tank. These simplified models show the conceptual potential of different solid-state hydrogen storage systems. In the simulations, the tank has the simplest geometry, i.e. a tube with an external jacket for thermal fluid circulation. This double tube has the diameter of the external jacket 10% higher than the internal one and tubes are 3 mm thick. This simplification is introduced because different wall materials have different tensile strengths and therefore the wall thickness would, indeed, vary with material, as well as with temperature. In the model, water is considered as thermal fluid and it contributes to the gravimetric capacity of the system in relation to the amount of water flowing in the jacket, without considering the flow rate. In fact, this value is related to the thermal exchange necessary for the hydrogen sorption reactions, but it influences neither the gravimetric nor the volumetric density of the system. This simplification is also due to the fact that, although high temperature hydrides like MgH₂, LiBH₄ and even NaAlH₄ cannot realistically be tempered using water (since at temperatures of 180–400 °C, as required by these hydrides, water is in the form of steam and not well suited as a heat exchange agent), the comparison of systems using different heat exchange agents would be much too detailed for this frame. The amount of hydrogen stored in the system is 1 kg. The H₂-carrier powder has a percentage of compactness of 90% and, inside the tube, a free volume of 20% is left to allow MH expansion during hydrogen absorption. To evaluate also the material of the container, simulations include the use of both aluminium and steel. A further simplification is implicit here, because the tensile strength of materials is significantly influenced by temperature. Therefore, aluminium would be unsuitable for tanks containing MgH₂ or LiBH₄, or at least, the wall thicknesses required would be so high as to render the comparison meaningless. Therefore, the hydrides must be understood as ideal comparison cases, in which only the different hydrogen storage capacities make a difference and other operating conditions are left unconsidered. In each simulation, the length of tube is calculated in relation to its diameter, from the volume necessary for the H₂-carrier. The volume of the system is then constant after having defined the volumetric capacity of MH.

Fig. 12 shows how the gravimetric capacity of the system changes as a function of the gravimetric (a) and volumetric (b) capacity of the hydrogen carrier MH. In Fig. 12a (left), for the MH, three volumetric capacities of MH were compared. The gravimetric capacity of system grows faster for low gravimetric capacity values, but it seems to come to a plateau for high values of MH wt.% H₂. Thus, an increase of the carrier gravimetric capacity has a higher influence on the gravimetric capacity of the system for low values of MH wt.% H₂, with respect to the high ones. In addition, as expected, the higher the MH volumetric capacity, the higher the gravimetric capacity of the system. Finally, the gravimetric capacity of the system reaches about half of that of the MH when using aluminium tubes, and it reaches about one fourth the case of using steel. As said above, this changes radically when taking into account the operating temperature [181]. In Fig. 12b, the

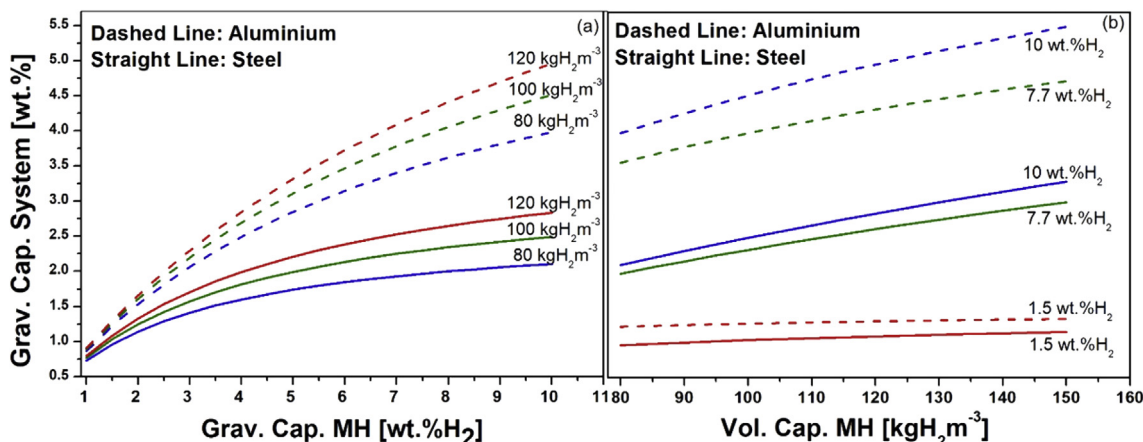

Fig. 12 – (a) Gravimetric capacity of the system as a function of the gravimetric capacity of MH, using a volumetric capacity of MH equal to 80–100–120 $\text{kgH}_2\text{m}^{-3}$ (b) Gravimetric capacity of the system as a function of the volumetric capacity of the MH, using a gravimetric capacity of MH of 1.5–7.7–10 wt.% H_2 . In both cases, it was considered a diameter of tube of 10 cm in aluminium (dashed line) and steel (straight line).

gravimetric capacity of the system is reported as a function of the MH volumetric capacity, considering three values for the MH gravimetric capacity. It is clear that the influence on system gravimetric capacity is roughly linear as a function of the MH volumetric capacity. Changes in gravimetric capacity of the system as a function of MH volumetric capacity are more remarkable for carriers with values of 7.7 and 10 wt.% H_2 , rather than for carriers with 1.5 wt.% H_2 . Moreover, the use of aluminium instead of steel has a minimal difference for carriers with 1.5 wt.% H_2 , while a strong effect is registered for

higher values of MH wt.% H_2 . The different thermal conductivity of the two materials considered here for the tank might have an effect on the thermo-fluid dynamic properties of the system, which are not considered here.

Fig. 13 shows the results of the estimation of the gravimetric capacity of the system as a function of diameter of tube used for the tank. As mentioned previously, the thermo-fluid dynamic is neglected, evaluating only the effect of gravimetric and volumetric capacity of MHs on the system properties. In Fig. 13a, an MH with a gravimetric and volumetric

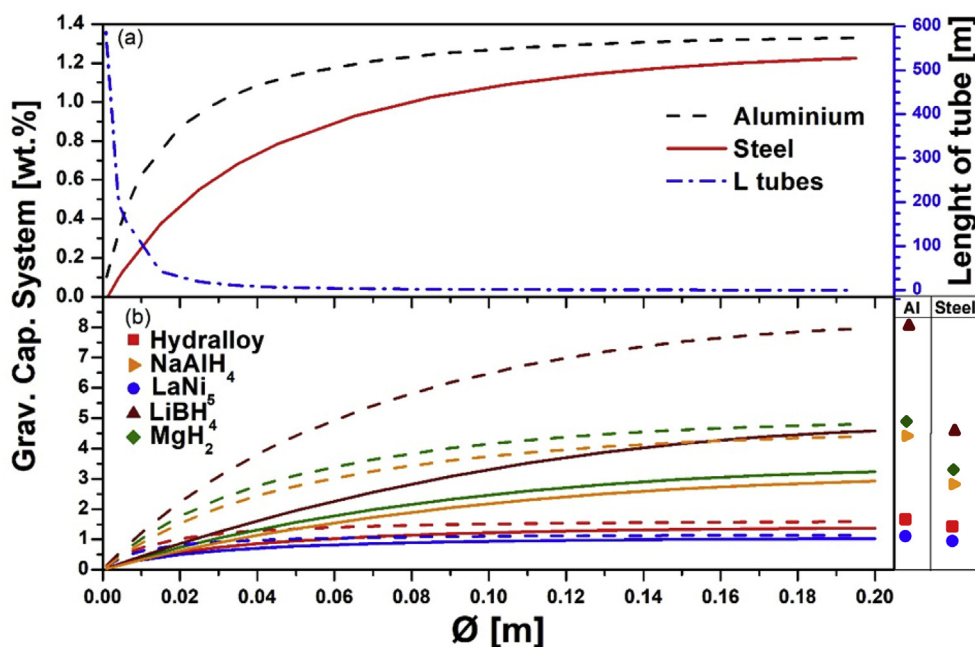

Fig. 13 – The gravimetric capacity of the system as a function of the diameter of tube. (a) Curves have been obtained considering a MH with a gravimetric and volumetric capacity of 1.5 wt.% H_2 and 100 $\text{kgH}_2\text{m}^{-3}$, respectively. The gravimetric capacity of the system is calculated for aluminium (dashed line) and steel (straight line) tube. It is also reported in dashed dot line the variation of the length of tube as a function of the diameter. (b) The gravimetric capacity of the system is reported considering different hydrides.

Table 6 – Theoretical gravimetric and volumetric capacity of Hydralloy, NaAlH₄, LaNi₅, LiBH₄ and MgH₂ and their volumetric capacity of the system using the SSH2S simplified tank geometry to calculate the amounts to be stored.

MH	Grav. Cap. [wt.%]	Vol. Cap. [kgH ₂ m ⁻³]	Vol. Cap. System [kgH ₂ m ⁻³]
Hydralloy [182]	1.6	115	57
NaAlH ₄ [183]	7.3	93	46
LaNi ₅ [184]	1.5	115	57
LiBH ₄ [183]	18.4	122	61
MgH ₂ [184]	7.7	110	55

capacity equal to 1.5 wt.% H₂ and 100 kgH₂m⁻³, respectively, was considered. To maximize the heat management, the container should have a diameter as smallest as possible, since the heat transfer distance is short and there is a better heat dissipation compared to large diameters. Thus, the simulation considers at the beginning tubes which are longer than wide, until the difference between the length and diameter is becoming minimal, as reported in Fig. 13a. In fact, as expected, the length of tube decreases asymptotically when increasing the diameter. The gravimetric capacity of the system grows progressively increasing the tube diameter, moving towards a plateau for high values. This result suggests that very small diameters are not practical, but from a certain value, an increase of the tube diameter does not have a relevant impact on the system gravimetric capacity. This shows the importance of considering all the factors in the simulation, since the conclusions might very well be different when taking into account also the heat exchange, as shown by Lozano et al. [181]. Thus, in practice, tubes are longer than wider, but without exceedingly large dimensions in any of the axis. Moreover, the use of steel or aluminium as material for tubes has a minor effect on wider tubes, but it influences the gravimetric capacity of narrower ones considerably, as it has also been calculated elsewhere [181].

Finally, the gravimetric capacity of the system was evaluated as a function of the diameter of the internal tube considering specific hydrogen carriers, i.e. Hydralloy, NaAlH₄, LaNi₅, LiBH₄ and MgH₂ (Fig. 13b). Corresponding values of gravimetric and volumetric capacity of the carrier are reported in Table 6. These values were taken from theory and should therefore be compared to those in Table 1 for a balanced analysis.

Low values of MH gravimetric capacity (i.e. LaNi₅ and Hydralloy) do not have a particular influence on the system and the difference in using aluminium or steel for tubes is negligible. On the contrary, for high value of MH gravimetric capacity (i.e. MgH₂, NaAlH₄ and LiBH₄) there is much more increase in the gravimetric capacity of the system by increasing the diameter of tube. In addition, the use of aluminium or steel for tubes has a bigger influence for LiBH₄, which has an elevated gravimetric capacity, than the other two hydrides. The reduction of the gravimetric capacity of system is higher for materials with higher values of MH gravimetric capacity. Finally, considering the volumetric capacity of the system, there is a linear trend as a function of the

volumetric capacity of MHs, as can be seen from the table, reaching a value close to half that of the MHs.

Conclusions and outlook

In the previous pages, a wide panoply of applications for hydrides has been shown, ranging from quite mature systems (as in the case of the submarines) which have been in service for decades, to experimental results obtained in the last few years, which have had no opportunity to find their way into widespread introduction into the market.

If a common feature or characteristic should be pointed out, the following observation seems pertinent: besides the fulfillment of the boundary conditions for hydrogen storage relating to weight, volume, operating pressures and temperatures as well as hydrogen flow, the most successful systems are those that combine a system as simple as possible with the achievement of a target that could not be reached using other alternatives.

A case in point is the usage of low temperature hydrides in submarines. In this case, lack of oxygen means that the usual, tried-and-true power machinery based on hydrocarbon combustion (diesel engines, turbines, etc.) cannot be used for underwater navigation. The high efficiency of fuel cells made hydrogen a winning proposition (albeit not the only one: both the Walter turbine, the Dutch Stirling system, the MESMA turbine and the closed loop diesel systems worked without hydrogen and proved to be feasible). The metal hydride option for hydrogen storage was, in this case, a matter of selecting the option with the lowest volume and simplest operation. Simplicity is here a relative concept, given the fact that submarines are highly complex machines in and of themselves. But the alternatives offered fewer advantages and the successful operation of the U212A submarines and their sisters has vindicated the concept.

Another case in which hydrides overwhelmingly surpass other storage alternatives is heat storage. In this case, the high reaction enthalpy available to store the energy means that the amount of storage material can be radically reduced [185]. This brings a reduction in real estate occupation, size of hot equipment and an increase in safety due to all these improvements happening at the same time. Crucially, the alternatives are required to operate under the same harsh conditions that are essential to the implementation of high temperature hydrides. Therefore, simplicity is again reached, not by having a more basic design with less operating parts, but by adapting to a very demanding environment using the intrinsic characteristics of the hydrides themselves.

If this general line is to be kept for other applications, it is essential to select the most suitable hydride for them. It is also important to be aware of the fact that ingenuity in the engineering of the technical solutions using hydrides may be as much the key to their successful application as the characteristics of the hydrides on their own.

In the future, changing conditions in the energy policies of major powers may well give a decisive impulse to such advanced but less well-known technologies, such as hydrides for hydrogen storage and other energy-related applications. In this case, energy generation could switch from fossil fuel

based power plants to regenerative energy based ones. Thus, high temperature hydrides can be expected to be developed into successful heat storage materials not only due to their intrinsic suitability, as already explained, but especially in the concentrated solar power arena, due to the fact that such power plants are essentially more profitable when going to the additional complexity and cost of storing heat than when they are limited to daylight operations.

In the field of mobile applications, especially road bound vehicular ones, the technology for hydrogen usage is already mature enough to be introduced to the public [186]. Metal hydrides have played a role from an early time [187] in the consideration of hydrogen as a fuel for vehicular applications, but for a time it looked like the boundary conditions for their usage were not adequate in this environment [105]. However, the latest developments in the field of complex hydrides open the possibility of their usage in this arena [188].

In general, the acceptance of hydrogen as a part of the energy vector portfolio in our modern society will give rise to further opportunities for the application of hydrides in their various forms, even if this process may take some time.

Acknowledgements

The research for the lab-scale compressor is part of the activities of SCCER HaE, which is financially supported by Innosuisse - Swiss Innovation Agency.

The authors thank the Alexander von Humboldt Foundation in the frame of the post-doctoral fellowship of Dr. J. Puzkiel (No. 1187279 STP) as well as the European Union for their funding of projects STORHY (contract Nr. SES6-CT-2004-502667, FP6-2002-Energy-1, 6.1.3.2.2), NESSHY (contract Nr. 518271, FP6-2004-Energy-3, 6.1.3.2.2) and the EU Horizon 2020/RISE project HYDRIDE4MOBILITY.

Financial support from the European Union's Seventh Framework Programme (FP7/2007e2013) for the Fuel Cells and Hydrogen Joint Technology Initiative under grant agreement no. 256653 (SSH2S), from the European Fuel Cells and Hydrogen Joint Undertaking in the framework of BOR4STORE (Grant agreement no. 303428), from the Australian Research Council for grants LP120101848, LP150100730, and LE0989180, The Innovation Fund Denmark (project HyFill-Fast), DST within Hydrogen South Africa/HySA programme (projects KP3–S02 and KP8–S05), the National Research Foundation/NRF of South Africa, incentive funding grant number 109092 and the Research Council of Norway (project 285147) is thankfully acknowledged.

REFERENCES

- [1] Rizzi P, Pinatel E, Luetto C, Florian P, Graizzaro A, Gagliano S, et al. Integration of a PEM fuel cell with a metal hydride tank for stationary applications. *J Alloy Comp* 2015;645:S338–42.
- [2] Gkanas EI, Khzouz M, Panagakos G, Statheros T, Mihalakakou G, Siasos GI, et al. Hydrogenation behavior in rectangular metal hydride tanks under effective heat management processes for green building applications. *Energy* 2018;142:518–30.
- [3] Dematteis EM, Vaunois S, Pistidda C, Dornheim M, Baricco M. Reactive hydride composite of Mg₂NiH₄ with borohydrides eutectic mixtures. *Crystals* 2018;8:12.
- [4] Sun YH, Shen CQ, Lai QW, Liu W, Wang DW, Aguey-Zinsou KF. Tailoring magnesium based materials for hydrogen storage through synthesis: current state of the art. *Energy Storage Mater* 2018;10:168–98.
- [5] Chaise A, de Rango P, Marty P, Fruchart D, Miraglia S, Olivès R, et al. Enhancement of hydrogen sorption in magnesium hydride using expanded natural graphite. *Int J Hydrogen Energy* 2009;34:8589–96.
- [6] Khandelwal A, Agresti F, Capurso G, Lo Russo S, Maddalena A, Gialanella S, et al. Pellets of MgH₂-based composites as practical material for solid state hydrogen storage. *Int J Hydrogen Energy* 2010;35:3565–71.
- [7] Jepsen J, Milanese C, Girella A, Lozano GA, Pistidda C, Bellosta von Colbe JM, et al. Compaction pressure influence on material properties and sorption behaviour of LiBH₄–MgH₂ composite. *Int J Hydrogen Energy* 2013;38:8357–66.
- [8] Cao H, Georgopoulos P, Capurso G, Pistidda C, Weigelt F, Chaudhary A-L, et al. Air-stable metal hydride-polymer composites of Mg(NH₂)₂–LiH and TPX™. *Mater Today Energy* 2018;10:98–107.
- [9] Gattia DM, Montone A, Di Sarcina I. Improving magnesium based systems for efficient hydrogen storage tanks. *Int J Hydrogen Energy* 2016;41:14455–60.
- [10] Tabor DP, Roch LM, Saikin SK, Kreisbeck C, Sheberla D, Montoya JH, et al. Accelerating the discovery of materials for clean energy in the era of smart automation. *Nat Rev Mater* 2018;3:16.
- [11] Lototsky MV, Tolj I, Pickering L, Sita C, Barbir F, Yartys V. The use of metal hydrides in fuel cell applications. *Prog Nat Sci* 2017;27:3–20.
- [12] Kikkinides ES, Georgiadis MC, Stubos AK. Dynamic modelling and optimization of hydrogen storage in metal hydride beds. *Energy* 2006;31:2428–46.
- [13] Mohammadshahi SS, Gray EM, Webb CJ. A review of mathematical modelling of metal-hydride systems for hydrogen storage applications. *Int J Hydrogen Energy* 2016;41:3470–84.
- [14] Tokyo aims to realize “hydrogen society”. 2020. https://www.japan.go.jp/tomodachi/2016/spring2016/tokyo_realize_hydrogen_by_2020.html.
- [15] Parissis OS, Zoulias E, Stamatakis E, Sioulas K, Alves L, Martins R, et al. Integration of wind and hydrogen technologies in the power system of Corvo island, Azores: a cost-benefit analysis. *Int J Hydrogen Energy* 2011;36:8143–51.
- [16] Luta DN, Raji AK. Decision-making between a grid extension and a rural renewable off-grid system with hydrogen generation. *Int J Hydrogen Energy* 2018;43:9535–48.
- [17] Gray EM, Webb CJ, Andrews J, Shabani B, Tsai PJ, Chan SLI. Hydrogen storage for off-grid power supply. *Int J Hydrogen Energy* 2011;36:654–63.
- [18] Biemann M, Vogt UF, Zimmermann M, Züttel A. Seasonal energy storage system based on hydrogen for self sufficient living. *J Power Sources* 2011;196:4054–60.
- [19] Delhomme B, Lanzini A, Ortigoza-Villalba GA, Nachev S, de Rango P, Santarelli M, et al. Coupling and thermal integration of a solid oxide fuel cell with a magnesium hydride tank. *Int J Hydrogen Energy* 2013;38:4740–7.
- [20] Yiotis AG, Kainourgiakis ME, Kosmidis LI, Charalambopoulou GC, Stubos AK. Thermal coupling potential of Solid Oxide Fuel Cells with metal hydride tanks:

- thermodynamic and design considerations towards integrated systems. *J Power Sources* 2014;269:440–50.
- [21] Parra D, Gillott M, Walker GS. Design, testing and evaluation of a community hydrogen storage system for end user applications. *Int J Hydrogen Energy* 2016;41:5215–29.
- [22] Bhogilla SS, Ito H, Segawa T, Kato A, Nakano A. Experimental study on laboratory scale Totalized Hydrogen Energy Utilization System using wind power data. *Int J Hydrogen Energy* 2017;42:13827–38.
- [23] Song C, Klebanoff LE, Johnson TA, Chao BS, Socha AF, Oros JM, et al. Using metal hydride H₂ storage in mobile fuel cell equipment: design and predicted performance of a metal hydride fuel cell mobile light. *Int J Hydrogen Energy* 2014;39:14896–911.
- [24] Menictas C, Skyllas-Kazacos M, Lim TM. Advances in batteries for medium and large-scale energy storage: types and applications. Elsevier; 2014.
- [25] Toshiba autonomous hydrogen energy for Kyushu hotel, JR East. *Fuel Cells Bull* 2016;2016:6.
- [26] Kubo K, Kawaharazaki Y, Itoh H. Development of large MH tank system for renewable energy storage. *Int J Hydrogen Energy* 2017;42:22475–9.
- [27] Valverde L, Rosa F, Bordons C, Guerra J. Energy management strategies in hydrogen smart-grids: a laboratory experience. *Int J Hydrogen Energy* 2016;41:13715–25.
- [28] Liu W, Webb CJ, Gray EM. Review of hydrogen storage in AB₃ alloys targeting stationary fuel cell applications. *Int J Hydrogen Energy* 2016;41:3485–507.
- [29] Lohner T, D'Aveni A, Dehouche Z, Johnson P. Integration of large-scale hydrogen storages in a low-carbon electricity generation system. *Int J Hydrogen Energy* 2013;38:14638–53.
- [30] Thattai AT, Wittebrood BJ, Woudstra T, Geerlings JJC, Aravind PV. Thermodynamic system studies for a natural gas combined cycle (NGCC) plant with CO₂ capture and hydrogen storage with metal hydrides. *Energy Procedia* 2014;63:1996–2007.
- [31] Soloveichik GL. Regenerative fuel cells for energy storage. *Proc IEEE* 2014;102:964–75.
- [32] Jehan M, Fruchart D. McPhy-Energy's proposal for solid state hydrogen storage materials and systems. *J Alloy Comp* 2013;580:S343–8.
- [33] McPhy couples solid hydrogen storage and industrial electrolysis. *Fuel Cells Bull* 2013;2013:7–8.
- [34] Andrews J, Shabani B. Re-envisioning the role of hydrogen in a sustainable energy economy. *Int J Hydrogen Energy* 2012;37:1184–203.
- [35] Moller KT, Sheppard D, Ravnsbaek DB, Buckley CE, Akiba E, Li HW, et al. Complex metal hydrides for hydrogen, thermal and electrochemical energy storage. *Energies* 2017;10:30.
- [36] Reiser A, Bogdanović B, Schlichte K. The application of Mg-based metal-hydrides as heat energy storage systems. *Int J Hydrogen Energy* 2000;25:425–30.
- [37] Harries DN, Paskevicius M, Sheppard DA, Price TEC, Buckley CE. Concentrating solar thermal heat storage using metal hydrides. *Proc IEEE* 2012;100:539–49.
- [38] Fellet M, Buckley CE, Paskevicius M, Sheppard DA. Research on metal hydrides revived for next-generation solutions to renewable energy storage. *MRS Bull* 2013;38:1012–3.
- [39] Sheppard DA, Corngale C, Hardy B, Motyka T, Zidan R, Paskevicius M, et al. Hydriding characteristics of NaMgH₂F with preliminary technical and cost evaluation of magnesium-based metal hydride materials for concentrating solar power thermal storage. *RSC Adv* 2014;4:26552–62.
- [40] Rönnebro ECE, Whyatt G, Powell M, Westman M, Zheng F, Fang ZZ. Metal hydrides for high-temperature power generation. *Energies* 2015;8:8406–30.
- [41] Sheppard DA, Humphries TD, Buckley CE. What is old is new again. *Mater Today* 2015;18:414–5.
- [42] Sheppard DA, Humphries TD, Buckley CE. Sodium-based hydrides for thermal energy applications. *Appl Phys Mater Sci Process* 2016;122:13.
- [43] Sheppard DA, Paskevicius M, Humphries TD, Felderhoff M, Capurso G, Bellosta von Colbe JM, et al. Metal hydrides for concentrating solar thermal power energy storage. *Appl Phys Mater Sci Process* 2016;122:15.
- [44] Ward PA, Corngale C, Teprovich JA, Motyka T, Hardy B, Sheppard D, et al. Technical challenges and future direction for high-efficiency metal hydride thermal energy storage systems. *Appl Phys Mater Sci Process* 2016;122:10.
- [45] Javadian P, Sheppard DA, Jensen TR, Buckley CE. Destabilization of lithium hydride and the thermodynamic assessment of the Li-Al-H system for solar thermal energy storage. *RSC Adv* 2016;6:94927–33.
- [46] Humphries TD, Sheppard DA, Rowles MR, Sofianos MV, Buckley CE. Fluoride substitution in sodium hydride for thermal energy storage applications. *J Mater Chem A* 2016;4:12170–8.
- [47] Nguyen TT, Sheppard DA, Buckley CE. Lithium imide systems for high temperature heat storage in concentrated solar thermal systems. *J Alloy Comp* 2017;716:291–8.
- [48] Tortoza MS, Humphries TD, Sheppard DA, Paskevicius M, Rowles MR, Sofianos MV, et al. Thermodynamics and performance of the Mg-H-F system for thermochemical energy storage applications. *Phys Chem Chem Phys* 2018;20:2274–83.
- [49] Dong D, Humphries TD, Sheppard DA, Stansby B, Paskevicius M, Sofianos MV, et al. Thermal optimisation of metal hydride reactors for thermal energy storage applications. *Sustain Energy Fuels* 2017;1:1820–9.
- [50] Capurso G, Schiavo B, Jepsen J, Lozano G, Metz O, Saccone A, et al. Development of a modular room-temperature hydride storage system for vehicular applications. *Appl Phys Mater Sci Process* 2016;122:11.
- [51] Reilly JJ, Wiswall Jr RH. Formation and properties of iron titanium hydride. *Inorg Chem* 1974;13:218–22.
- [52] Gamo T, Moriwaki Y, Yanagihara N, Yamashita T, Iwaki T. Formation and properties of titanium manganese alloy hydrides. *Int J Hydrogen Energy* 1985;10:39–47.
- [53] Sandrock G, Bowman Jr RC. Gas-based hydride applications: recent progress and future needs. *J Alloy Comp* 2003;356–357:794–9.
- [54] Haraki T, Oishi K, Uchida H, Miyamoto Y, Abe M, Kokaji T, et al. Properties of hydrogen absorption by nano-structured FeTi alloys. *Int J Mater Res* 2008;99:507–12.
- [55] Lototskyy MV, Yartys VA, Pollet BG, Bowman RC. Metal hydride hydrogen compressors: a review. *Int J Hydrogen Energy* 2014;39:5818–51.
- [56] Lototskyy MV, Davids MW, Tolj I, Klochko YV, Sekhar BS, Chidziva S, et al. Metal hydride systems for hydrogen storage and supply for stationary and automotive low temperature PEM fuel cell power modules. *Int J Hydrogen Energy* 2015;40:11491–7.
- [57] Schlapbach L. Hydrogen in intermetallic compounds II: surface and dynamic properties, applications. topics in applied physics. Berlin, Heidelberg: Springer-Verlag Springer e-books; 2005. p. 1 [online resource].
- [58] Muthukumar P, Groll M. Metal hydride based heating and cooling systems: a review. *Int J Hydrogen Energy* 2010;35:3817–31.
- [59] Chen GZ, Fray DJ, Farthing TW. Direct electrochemical reduction of titanium dioxide to titanium in molten calcium chloride. *Nature* 2000;407:361–4.
- [60] Zhang W, Zhu Z, Cheng CY. A literature review of titanium metallurgical processes. *Hydrometallurgy* 2011;108:177–88.

- [61] Davids MW, Lototskyy M, Pollet BG. Manufacturing of hydride-forming alloys from mixed titanium-iron oxide. 2013 Asian pacific conference on chemical, material and metallurgical engineering. Beijing: APCCMME 2013; 2013. p. 14–22.
- [62] Corgnale C, Hardy B, Motyka T, Zidan R, Teprovič J, Peters B. Screening analysis of metal hydride based thermal energy storage systems for concentrating solar power plants. *Renew Sustain Energy Rev* 2014;38:821–33.
- [63] Pohlmann C, Röntzsch L, Hu J, Weißgärber T, Kieback B, Fichtner M. Tailored heat transfer characteristics of pelletized LiNH₂-MgH₂ and NaAlH₄ hydrogen storage materials. *J Power Sources* 2012;205:173–9.
- [64] Pohlmann C, Röntzsch L, Heubner F, Weißgärber T, Kieback B. Solid-state hydrogen storage in Hydralloy-graphite composites. *J Power Sources* 2013;231:97–105.
- [65] Capurso G, Schiavo B, Jepsen J, Lozano GA, Metz O, Klassen T, et al. Metal hydride-based hydrogen storage tank coupled with an urban concept fuel cell vehicle: off board tests. *Adv Sustain Sys* 2018;2:1800004.
- [66] Bogdanović B, Brand RA, Marjanović A, Schwickardi M, Tölle J. Metal-doped sodium aluminium hydrides as potential new hydrogen storage materials. *J Alloy Comp* 2000;302:36–58.
- [67] Fossdal A, Brinks HW, Fonnepel JE, Hauback BC. Pressure-composition isotherms and thermodynamic properties of TiF₃-enhanced Na(2)LiAlH(6). *J Alloy Comp* 2005;397:135–9.
- [68] Graetz J, Lee Y, Reilly JJ, Park S, Vogt T. Structures and thermodynamics of the mixed alkali alanates. *Phys Rev B* 2005;71:184115.
- [69] Mamatha M, Weidenthaler C, Pommerin A, Felderhoff M, Schuth F. Comparative studies of the decomposition of alanates followed by in situ XRD and DSC methods. *J Alloy Comp* 2006;416:303–14.
- [70] Xiong ZT, Hu JJ, Wu GT, Chen P, Luo WF, Gross K, et al. Thermodynamic and kinetic investigations of the hydrogen storage in the Li-Mg-N-H system. *J Alloy Comp* 2005;398:235–9.
- [71] Pori, editor. Software: HSC chemistry. 6.12. Finland: Outotec Research Oy; 2006.
- [72] Wagman DD, Evans WH, Parker VB, Schumm RH, Halow I, Bailey SM, et al. The NBS tables of chemical thermodynamic properties - selected values for inorganic and C-1 and C-2 organic-substances in SI units. *J Phys Chem Ref Data* 1982;11.
- [73] Gavrichev KS. Heat capacity and thermodynamic properties of inorganic compounds containing tetrahedral anions (BH₄⁻, AlH₄⁻, GaH₄⁻, BF₄⁻, ClO₄⁻, BrO₄⁻, and IO₄⁻). *Inorg Mater* 2003;39:S89–112.
- [74] Jacobs H. Crystal structure of magnesium amide. *Zeitschrift Fur Anorganische Und Allgemeine Chemie* 1971;382:97. & ff.
- [75] Vidal JP, Vidalvalat G. Accurate debye-waller factors of (LIH)-LI-7 and (LID)-LI-7 by neutron-diffraction at 3 temperatures. *Acta Crystallogr Sect B Struct Sci* 1986;42:131–7.
- [76] Li GP, Nishimiya N, Satoh H, Kamegashira N. Crystal structure and hydrogen absorption of TixZr1-xMn2. *J Alloy Comp* 2005;393:231–8.
- [77] Fouquet DM, Razvi J, Whittemore WL. TRIGA research reactors: a pathway to the peaceful applications of nuclear energy. *Nucl News* 2003;46:46–56.
- [78] TRIGA® nuclear reactors. Available from: <http://www.ga.com/triga>.
- [79] Jogalekar A. The future of nuclear power: let a thousand flowers bloom. 2013. <https://blogs.scientificamerican.com/the-curious-wavefunction/the-future-of-nuclear-power-let-a-thousand-flowers-bloom/>.
- [80] Wei C, Daohua W, Xinbiao J, Jinyan A, Jun Y, Da C. The uranium zirconium hydride research reactor and its applications in research and education. JAERI conf. 2003. Japan: Japan Atomic Energy Research Institute; 2001.
- [81] Yoshida T, Kojima K. Toyota MIRAI fuel cell vehicle and progress toward a future hydrogen society. *Electrochem Soc Interfac* 2015;24:45–9.
- [82] Metz S. Linde pioneers hydrogen compression techniques for fuel cell electric vehicles. *Fuel Cells Bull* 2014;2014:12–5.
- [83] Wang X, Chen R, Zhang Y, Chen C, Wang Q. Hydrogen storage alloys for high-pressure suprapure hydrogen compressor. *J Alloy Comp* 2006;420:322–5.
- [84] Ohlendorf D, Flotow HE. Heat capacities and thermodynamic functions of LaNi₅, LaNi₅H_{0.36} and LaNi₅H_{0.6}. 39 from 5 to 300 K. *J Less Common Met* 1980;73:25–32.
- [85] Gallandat N, Berard J, Abbet F, Züttel A. Small-scale demonstration of the conversion of renewable energy to synthetic hydrocarbons. *Sustain Energy Fuels* 2017;1:1748–58.
- [86] Yartys VA, Lototskyy M, Linkov V, Grant D, Stuart A, Eriksen J, et al. Metal hydride hydrogen compression: recent advances and future prospects. *Appl Phys A* 2016;122.
- [87] Eriksen J, Denys R. HYMEHC - the thermal hydrogen compressor by HYSTORSYS. 20th world hydrogen energy conference, WHEC 2014. Committee of WHEC2014; 2014. p. 603–6.
- [88] Lototskyy M, Klochko Y, Davids MW, Pickering L, Swanepoel D, Louw G, et al. Industrial-scale metal hydride hydrogen compressors developed at the South African Institute for Advanced Materials Chemistry. *Mater Today-Proc* 2018;5:10514–23.
- [89] Tarasov BP, Bocharnikov MS, Yanenko YB, Fursikov PV, Lototskyy MV. Cycling stability of RNi₅ (R = La, La plus Ce) hydrides during the operation of metal hydride hydrogen compressor. *Int J Hydrogen Energy* 2018;43:4415–27.
- [90] Pickering L, Reed D, Bevan AI, Book D. Ti-V-Mn based metal hydrides for hydrogen compression applications. *J Alloy Comp* 2015;645:S400–3.
- [91] Karagiorgis G, Christodoulou CN, von Storch H, Tzamalīs G, Deligiannis K, Hadjipetrou D, et al. Design, development, construction and operation of a novel metal hydride compressor. *Int J Hydrogen Energy* 2017;42:12364–74.
- [92] Johnson T. DOE Hydrogen and Fuel Cells Program: 2017 Annual Merit Review Proceedings - hydrogen fuel R&D: metal hydride compression.
- [93] Mitrokhin S, Zotov T, Movlaev E, Verbetsky V. Synthesis and properties of AB₅-type hydrides at elevated pressures. *J Alloy Comp* 2007;446–447:603–5.
- [94] Gross KJ, Carrington KR, Barcelo S, Karkamkar A, Purewal J. Recommended best practices for the characterization of storage properties of hydrogen storage materials. US Department of Energy, Office of Energy Efficiency and Renewable Energy Hydrogen Storage Program; 2012.
- [95] Yang F, Zhang Y, Ciucci F, Wu Z, Wang S, Wang Y, et al. Towards a consistent understanding of the metal hydride reaction kinetics: measurement, modeling and data processing. *J Alloy Comp* 2018;741:610–21.
- [96] Jehan M, Fruchart D. McPhy-energy proposal for solid hydrogen storage materials and systems. Grenoble.
- [97] Lozano GA, Bellosta von Colbe JM, Klassen T, Dornheim M. Transport phenomena versus intrinsic kinetics: hydrogen sorption limiting sub-process in metal hydride beds. *Int J Hydrogen Energy* 2014;39:18952–7.

- [98] Suissa E, Jacob I, Hadari Z. Experimental measurements and general conclusions on the effective thermal conductivity of powdered metal hydrides. *J Less Common Met* 1984;104:287–95.
- [99] Pickering L, Lototskyy MV, Davids MW, Sita C, Linkov V. Induction melted AB(2)-type metal hydrides for hydrogen storage and compression applications. *Mater Today-Proc* 2018;5:10470–8.
- [100] Lototskyy MV. New model of phase equilibria in metal - hydrogen systems: features and software. *Int J Hydrogen Energy* 2016;41:2739–61.
- [101] The Top 10 biggest ships in the world. *Maritime Herald*; 2017. <http://www.maritimeherald.com/2017/top-10-biggest-ships-world/>.
- [102] D. Media International V.V. L. BHP breaks its own's heaviest train's record. 2001. <https://www.railwaygazette.com/news/single-view/view/bhp-breaks-its-own-39heaviest-train39-record.html>.
- [103] Scheuerle SPMT. Available from: <https://www.scheuerle.com/products/spmt.html>.
- [104] Antonov an-225 mriya - wikipedia. Avai;able from: <https://en.wikipedia.org/w/index.php?oldid=857595259>. Wikipedia.
- [105] Corgnale C, Hardy BJ, Tamburello DA, Garrison SL, Anton DL. Acceptability envelope for metal hydride-based hydrogen storage systems. *Int J Hydrogen Energy* 2012;37:2812–24.
- [106] Hans Pommer PH, Teppner Randolf, Hartung Werner. Außenluftunabhängiges Antriebssystem für Uboote. 2006.
- [107] Hauschildt P. Deutschland – die klasse 216. U-Boote für den weltweiten Einsatz; 2012.
- [108] Ball M, Basile A, Veziroglu TN. Compendium of hydrogen energy: hydrogen use, safety and the hydrogen economy. Elsevier Science; 2015.
- [109] Sattler G. PEFCs for naval ships and submarines: many tasks, one solution. *J Power Sources* 1998;71:144–9.
- [110] Sattler G. Fuel cells going on-board. *J Power Sources* 2000;86:61–7.
- [111] Psoma A, Sattler G. Fuel cell systems for submarines: from the first idea to serial production. *J Power Sources* 2002;106:381–3.
- [112] Rössler E. Die schnellen unterseeboote von Hellmuth walter. Bonn: Bernard und Graefe; 2010.
- [113] Brighton DR, Mart PL, Clark GA, Rowan MJM. The use of fuel-cells to enhance the underwater performance of conventional diesel electric submarines. *J Power Sources* 1994;51:375–89.
- [114] Fiori C, Dell'Era A, Zuccari F, Santiangeli A, D'Orazio A, Orecchini F. Hydrides for submarine applications: overview and identification of optimal alloys for air independent propulsion maximization. *Int J Hydrogen Energy* 2015;40:11879–89.
- [115] Ghosh PC, Vasudeva U. Analysis of 3000 T class submarines equipped with polymer electrolyte fuel cells. *Energy* 2011;36:3138–47.
- [116] Rössler E, Fuchslocher HH. In: Aufl erw, editor. U-Boottyp XXI. 6. Bonn: Bernard und Graefe; 2002.
- [117] Krummrich S, Llabres J. Methanol reformer - the next milestone for fuel cell powered submarines. *Int J Hydrogen Energy* 2015;40:5482–6.
- [118] Hyakudome T, Yoshida H, Tsukioka S, Sawa T, Ishibashi S, Aoki T, et al. High efficiency hydrogen and oxygen storage system development for underwater platforms powered by fuel cell. In: Williams MC, Krist K, Garland N, editors. Fuel cell seminar 2009. Pennington: Electrochemical Soc Inc; 2010. p. 465–74.
- [119] Swider-Lyons K, Deitz D. Hydrogen fuel cells for unmanned undersea vehicle propulsion. *ECS trans* 2016;75:479–89.
- [120] Bevan AI, Züttel A, Book D, Harris IR. Performance of a metal hydride store on the "Ross Barlow" hydrogen powered canal boat. *Faraday Discuss* 2011;151:353–67.
- [121] Bowman J, Thompson S. The Mooresville hydrail initiative. *Int J Hydrogen Energy* 2004;29:438–40.
- [122] Hoffrichter A, Hillmansen S, Roberts C. Conceptual propulsion system design for a hydrogen-powered regional train. *IET Electr Syst Transp* 2016;6:56–66.
- [123] Fragiaco P, Francesco P. Energy performance of a Fuel Cell hybrid system for rail vehicle propulsion. In: Fortunato B, Ficarella A, Torresi M, editors. Ati 2017 - 72nd conference of the Italian thermal machines engineering association. Amsterdam: Elsevier Science Bv; 2017. p. 1051–8.
- [124] Fragiaco P, Piraino F. Numerical modelling of a PEFC powertrain system controlled by a hybrid strategy for rail urban transport. *J Energy Storage* 2018;17:474–84.
- [125] Japanese train company to test world's first fuel cell passenger train. *Fuel Cells Bull* 2006;2006:4.
- [126] Peng F, Chen W, Liu Z, Li Q, Dai C. System integration of China's first proton exchange membrane fuel cell locomotive. *Int J Hydrogen Energy* 2014;39:13886–93.
- [127] Barrett S. Editorial. *Fuel Cells Bull* 2017;2017:3.
- [128] Hsiao D-R, Huang B-W, Shih N-C. Development and dynamic characteristics of hybrid fuel cell-powered mini-train system. *Int J Hydrogen Energy* 2012;37:1058–66.
- [129] Pour AM, Dhir A, Steinberger-Wilckens R. ECS trans. In: Coupling and modeling an SOFC system with a high-performing metal hydride storage. 1 ed. Electrochemical Society Inc.; 2013. p. 243–53.
- [130] Hasegawa H, Ohki Y. Development of a model of on-board PEMFC powered locomotive with a metal hydride cylinder, vol. 393. Pittsburgh, PA, United States: Materials Research Society; 1995. p. 145–50.
- [131] News. Design milestone for fuel cell locomotive. *Fuel Cells Bull* 2004;2004:5.
- [132] Barnes D. Advanced underground vehicle power and control; the locomotive research platform denver. Vehicle Projects LLC; 2003.
- [133] Ralph S. Problems of bulk storage and shipping of liquid hydrogen in volumes of 10,000 to 100,000 cubic meters at one bar pressure. *International Institute of Refrigeration*; 2017. p. 140–4.
- [134] Notardonato WU, Swanger AM, Fesmire JE, Jumper KM, Johnson WL, Tomsik TM. In: Zero boil-off methods for large-scale liquid hydrogen tanks using integrated refrigeration and storage. 1 ed. Institute of Physics Publishing; 2017.
- [135] Plachta D, Stephens J, Johnson W, Zagarola M. NASA cryocooler technology developments and goals to achieve zero boil-off and to liquefy cryogenic propellants for space exploration. *Cryogenics* 2018;94:95–102.
- [136] Dryer FL, Chaos M, Zhao Z, Stein JN, Alpert JY, Homer CJ. Spontaneous ignition of pressurized releases of hydrogen and natural gas into air. *Combust Sci Technol* 2007;179:663–94.
- [137] Duan Q, Xiao H, Gao W, Gong L, Sun J. Experimental investigation of spontaneous ignition and flame propagation at pressurized hydrogen release through tubes with varying cross-section. *J Hazard Mater* 2016;320:18–26.
- [138] Duan Q, Xiao H, Gao W, Wang Q, Shen X, Jiang L, et al. An experimental study on shock waves and spontaneous ignition produced by pressurized hydrogen release through a tube into atmosphere. *Int J Hydrogen Energy* 2015;40:8281–9.
- [139] Duan Q, Zhang F, Xiong T, Wang Q, Xiao H, Wang Q, et al. Experimental study of spontaneous ignition and non-premixed turbulent combustion behavior following pressurized hydrogen release through a tube with local enlargement. *J Loss Prev Process Ind* 2017;49:814–21.
- [140] Gong L, Duan Q, Jiang L, Jin K, Sun J. Experimental study on flow characteristics and spontaneous ignition produced by

- pressurized hydrogen release through an Omega-shaped tube into atmosphere. *Fuel* 2016;184:770–9.
- [141] Gong L, Duan Q, Jiang L, Jin K, Sun J. Experimental study of pressure dynamics, spontaneous ignition and flame propagation during hydrogen release from high-pressure storage tank through 15 mm diameter tube and exhaust chamber connected to atmosphere. *Fuel* 2016;182:419–27.
- [142] Gou X, Zhou L. Numerical study on spontaneous ignition of pressurized hydrogen release in shock-tubes. *Taiyangneng Xuebao* 2015;36:2777–81.
- [143] Woof M. Technology for underground loading and hauling systems offers exciting prospects. *Eng Min J* 2005;206:32–8.
- [144] Desrivieres G, Bétournay M, Velev O, Barnes D. The development of hydrogen mine vehicle power plant functions controllers. 32nd int symposium on the application of computers and operations research in the mineral industry, APCOM2005. p. 595-601.
- [145] Rendina D. Hydrogen hydride keel US5445099 (A) ed. USA.
- [146] Gregory BA, Banko JE, Bordwell B, Field M, Medwin S. Material handling vehicle including integrated hydrogen storage. US020090166110A1 ed. USA.
- [147] Lototskyy MV, Tolj I, Davids MW, Klochko YV, Parsons A, Swanepoel D, et al. Metal hydride hydrogen storage and supply systems for electric forklift with low-temperature proton exchange membrane fuel cell power module. *Int J Hydrogen Energy* 2016;41:13831–42.
- [148] Lototskyy MV, Tolj I, Parsons A, Smith F, Sita C, Linkov V. Performance of electric forklift with low-temperature polymer exchange membrane fuel cell power module and metal hydride hydrogen storage extension tank. *J Power Sources* 2016;316:239–50.
- [149] Lototskyy M, Tolj I, Davids MW, Bujlo P, Smith F, Pollet BG. Distributed hybrid" MH-CGH₂ system for hydrogen storage and its supply to LT PEMFC power modules. *J Alloy Comp* 2015;645:S329–33.
- [150] Ley MB, Jepsen LH, Lee YS, Cho YW, Bellosta von Colbe JM, Dornheim M, et al. Complex hydrides for hydrogen storage - new perspectives. *Mater Today* 2014;17:122–8.
- [151] Moller KT, Jensen TR, Akiba E, Li HW. Hydrogen - a sustainable energy carrier. *Prog Nat Sci* 2017;27:34–40.
- [152] Jepsen J, Bellosta von Colbe JM, Klassen T, Dornheim M. Economic potential of complex hydrides compared to conventional hydrogen storage systems. *Int J Hydrogen Energy* 2012;37:4204–14.
- [153] Pepin J, Lainé E, Grandidier JC, Castagnet S, Blanc-vannet P, Papin P, et al. Determination of key parameters responsible for polymeric liner collapse in hyperbaric type IV hydrogen storage vessels. *Int J Hydrogen Energy* 2018;43:16386–99.
- [154] Barthelemy H, Weber M, Barbier F. Hydrogen storage: recent improvements and industrial perspectives. *Int J Hydrogen Energy* 2017;42:7254–62.
- [155] Takeichi N, Senoh H, Yokota T, Tsuruta H, Hamada K, Takeshita HT, et al. "Hybrid hydrogen storage vessel", a novel high-pressure hydrogen storage vessel combined with hydrogen storage material. *Int J Hydrogen Energy* 2003;28:1121–9.
- [156] Mori D, Hirose K. Recent challenges of hydrogen storage technologies for fuel cell vehicles. *Int J Hydrogen Energy* 2009;34:4569–74.
- [157] Shibuya M, Nakamura J, Akiba E. Hydrogenation properties and microstructure of Ti-Mn-based alloys for hybrid hydrogen storage vessel. *J Alloy Comp* 2008;466:558–62.
- [158] Kojima Y, Kawai Y, Towata Si, Matsunaga T, Shinozawa T, Kimbara M. Development of metal hydride with high dissociation pressure. *J Alloy Comp* 2006;419:256–61.
- [159] Matsunaga T, Shinozawa T, Washio K, Mori D, Ishikikiyama M. Development of metal hydrides for high pressure MH tank. Singapore: World Scientific Publ Co Pte Ltd; 2009.
- [160] Zotov TA, Sivov RB, Movlaev EA, Mitrokhin SV, Verbetsky VN. IMC hydrides with high hydrogen dissociation pressure. *J Alloy Comp* 2011;509:S839–43.
- [161] Jiang LJ, Tu YL, Tu HL, Chen LQ. Microstructures and hydrogen storage properties of ZrFe₂.05-xVx (x=0.05-0.20) alloys with high dissociation pressures for hybrid hydrogen storage vessel application. *J Alloy Comp* 2015;627:161–5.
- [162] Kumar A, Banerjee S, Bharadwaj SR. Hydrogen storage properties of Ti_{0.32}Cr_{0.43}V_{0.25} alloy and its composite with TiMn₂. *J Alloy Comp* 2015;649:801–8.
- [163] Cao ZJ, Ouyang LZ, Wang H, Liu JW, Sun DL, Zhang QA, et al. Advanced high-pressure metal hydride fabricated via Ti-Cr-Mn alloys for hybrid tank. *Int J Hydrogen Energy* 2015;40:2717–28.
- [164] Cao ZJ, Ouyang LZ, Wang H, Liu JW, Sun LX, Zhu M. Composition design of Ti-Cr-Mn-Fe alloys for hybrid high-pressure metal hydride tanks. *J Alloy Comp* 2015;639:452–7.
- [165] Liu LX, Chen LX, Xiao XZ, Xu CC, Sun J, Li SQ, et al. Influence of annealing treatment on the microstructure and hydrogen storage performance of Ti_{1.02}Cr_{1.1}Mn_{0.3}Fe_{0.6} alloy for hybrid hydrogen storage application. *J Alloy Comp* 2015;636:117–23.
- [166] Corgnale C, Hardy BJ, Anton DL. Structural analysis of metal hydride-based hybrid hydrogen storage systems. *Int J Hydrogen Energy* 2012;37:14223–33.
- [167] Sandrock G. State-of-the-Art review of hydrogen storage in reversible metal hydrides for military fuel cell applications. Department of the Navy, Office of Naval Research; 1997.
- [168] Strubel V. STORHY: hydrogen storage systems for automotive applications. Available from: https://www.hzg.de/science/eu_projects/fp6/key/047546/index.php.en. Magna Steyr Fahrzeugtechnik AG&Co KG.
- [169] Bellosta von Colbe JM, Metz O, Lozano GA, Pranzas PK, Schmitz HW, Beckmann F, et al. Behavior of scaled-up sodium alanate hydrogen storage tanks during sorption. *Int J Hydrogen Energy* 2012;37:2807–11.
- [170] Stubos A. Novel efficient solid storage for hydrogen | Projects | FP6 | CORDIS | European Commission. Available from: https://cordis.europa.eu/project/rcn/78769_de.html.
- [171] Delhomme B, De Rango P, Marty P, Bacia M, Zawilski B, Raufast C, et al. Large scale magnesium hydride tank coupled with an external heat source. *Int J Hydrogen Energy* 2012;37:9103–11.
- [172] Bellosta von Colbe JM, Lozano G, Metz O, Bücherl T, Bormann R, Klassen T, et al. Design, sorption behaviour and energy management in a sodium alanate-based lightweight hydrogen storage tank. *Int J Hydrogen Energy* 2015;40:2984–8.
- [173] Mazzucco A, Dornheim M, Sloth M, Jensen TR, Jensen JO, Rokni M. Bed geometries, fueling strategies and optimization of heat exchanger designs in metal hydride storage systems for automotive applications: a review. *Int J Hydrogen Energy* 2014;39:17054–74.
- [174] Mazzucco A, Rothuizen E, Jorgensen JE, Jensen TR, Rokni M. Integration of phase change materials in compressed hydrogen gas systems: modelling and parametric analysis. *Int J Hydrogen Energy* 2016;41:1060–73.
- [175] Jepsen LH, Ley MB, Lee YS, Cho YW, Dornheim M, Jensen JO, et al. Boron-nitrogen based hydrides and reactive composites for hydrogen storage. *Mater Today* 2014;17:129–35.
- [176] Paskevicius M, Jepsen LH, Schouwink P, Cerny R, Ravnsbaek DB, Filinchuk Y, et al. Metal borohydrides and derivatives - synthesis, structure and properties. *Chem Soc Rev* 2017;46:1565–634.
- [177] NEL. Unlocking The potential of renewables. Available from: <http://nelhydrogen.com>.

- [178] Baricco M, Bang M, Fichtner M, Hauback B, Linder M, Luetto C, et al. SSH2S: hydrogen storage in complex hydrides for an auxiliary power unit based on high temperature proton exchange membrane fuel cells. *J Power Sources* 2017;342:853–60.
- [179] Agostini A, Belmonte N, Masala A, Hu JJ, Rizzi P, Fichtner M, et al. Role of hydrogen tanks in the life cycle assessment of fuel cell-based auxiliary power units. *Appl Energy* 2018;215:1–12.
- [180] Hirscher M. Handbook of hydrogen storage: new materials for future energy storage. Weinheim: Wiley-VCH; 2010.
- [181] Lozano GA, Ranong CN, Bellosta von Colbe JM, Bormann R, Hapke J, Fieg G, et al. Optimization of hydrogen storage tubular tanks based on light weight hydrides. *Int J Hydrogen Energy* 2012;37:2825–34.
- [182] Herbrig K, Röntzsch L, Pohlmann C, Weissgarber T, Kieback B. Hydrogen storage systems based on hydride-graphite composites: computer simulation and experimental validation. *Int J Hydrogen Energy* 2013;38:7026–36.
- [183] Orimo SI, Nakamori Y, Eliseo JR, Züttel A, Jensen CM. Complex hydrides for hydrogen storage. *Chem Rev* 2007;107:4111–32.
- [184] Ordaz G. PJ, Read C., Satyapal S. . DOE Hydrogen Program 2005 Annual Merit Review and Peer Evaluation Report. p. 730.
- [185] Felderhoff M, Bogdanović B. High temperature metal hydrides as heat storage materials for solar and related applications. *Int J Mol Sci* 2009;10:325–44.
- [186] Nonobe Y. Development of the fuel cell vehicle mirai. *IEEJ Trans Electr Electron Eng* 2017;12:5–9.
- [187] Töpler J, Bernauer O, Buchner H, Saufferer H. Development of hydrides for motor vehicles. *J Less Common Met* 1983;89:519–26.
- [188] Bergemann N, Pistidda C, Milanese C, Aramini M, Huotari S, Nolis P, et al. A hydride composite featuring mutual destabilisation and reversible boron exchange: $\text{Ca}(\text{BH}_4)_2\text{-Mg}_2\text{NiH}_4$. *J Mater Chem A* 2018;33:532.