



Title	DEVELOPMENT OF A RELATIVE DISPLACEMENT SENSOR FOR STRUCTURAL HEALTH MONITORING
Author(s)	J. LI; H. HAO; K. FAN
Citation	
Issue Date	2013-09-11
DOI	
Doc URL	http://hdl.handle.net/2115/54205
Right	
Type	proceedings
Additional Information	
File Information	easec13-A-2-3.pdf



[Instructions for use](#)

DEVELOPMENT OF A RELATIVE DISPLACEMENT SENSOR FOR STRUCTURAL HEALTH MONITORING

J. LI^{1*†}, H. HAO¹, and K. FAN²

¹*School of Civil and Resource Engineering, University of Western Australia, Australia*

²*School of Information Engineering, Wuyi University, China*

ABSTRACT

This paper presents the structure, design principle, features and calibration of a developed relative displacement sensor for structural health monitoring. Relative displacement is measured from four strain gauges stuck on a square component connecting two pads, which are used to fix the sensor on the testing structure. The output voltage due to the shear distortion is calculated based on the principle of Wheatstone bridge circuit. The design of the sensor ensures that there are no voltage outputs for the tension, compression, bending and torsion effects. The developed relative displacement sensor is used to monitor the conditions of shear connectors in a composite bridge. The sensitive radius of the sensor to detect the deterioration of shear connectors is investigated. The developed sensor is easy to be installed on structures to detect conditions.

Keywords: Relative displacement sensor, sensor design and calibration, structural health monitoring, composite bridge, shear connector, condition assessment

1. INTRODUCTION

Composite bridges are built with concrete slab supported by the concrete or steel girders, and stirrups are embedded in the girders and cast into the slab as shear connectors to link the slab and girders. The shear connection between slab and girders subjects to the major consequences of stress, overloading and fatigue, especially for large structures such as bridge decks. It follows that damages usually involve a deterioration or break of the shear connection in some regions of the structure, causing a decrease of the overall rigidity and ultimate resistance of the bridge (Dilena and Morassi 2004). Damage of shear connectors will result in shear slippage between the slab and girder and therefore may result in the stiffness reduction even up to 17% in a short span bridge (Nie and Cai 2003). Composite structures represent a typical example of bridges in Australia for which the development of a sensor as a practical solution to track the shear slippage and failure of shear connectors would be of great interest due to the inaccessibility of the shear connection for direct inspection.

* Corresponding author: Email: jun.li@uwa.edu.au

† Presenter: Email: jun.li@uwa.edu.au

2. DEVELOPMENT OF RELATIVE DISPLACEMENT SENSOR

A relative displacement sensor is developed based on the principle of Wheatstone bridge circuit to measure the relative displacement between slab and girder in composite bridges. Four strain gauges are stuck on a square component connecting two pads, which are used to fix the sensor on the testing structure. The displacement is calibrated with measured strain and then the developed sensor can output the displacement information.

2.1. Sensor Structure

Figure 1 shows the structure of the developed relative displacement sensor. The sensitive component of the sensor is a square metallic block around 20mm with one end fixed on the girder and another end fixed on the concrete slab. The square metal block in the center is as thin as 1mm in order to prevent the installed sensor affecting local stiffness. The dimensions of the sensor are shown in Figure 2. Relative displacement between two points on a structure, i.e., the slab and girder in this study, which is the shear distortion of sensor, can be measured by the developed sensor. Four strain gauges are stuck on the square metal component as four diagonal lines to construct a Wheatstone bridge circuit as shown in Figure 3.

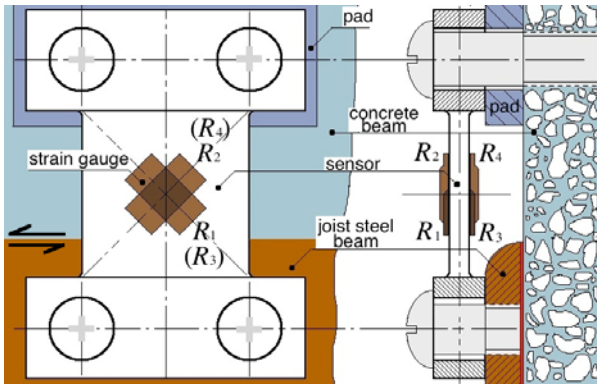

Figure 1: Schematic setup of the sensor

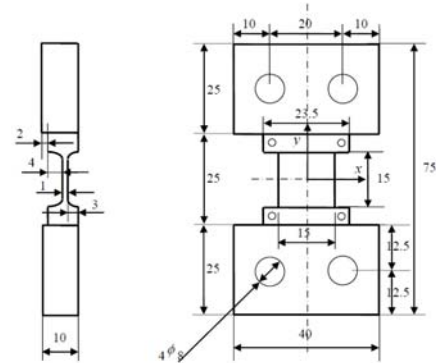

Figure 2: Dimensions of the sensor (mm)

2.2. Sensor Design Principle

The four arms of the bridge in Figure 3 are formed by the resistors R_1 to R_4 . The output voltage of the full bridge is calculated based on the principle of Wheatstone bridge circuit and is given as

$$\frac{v}{U} = \frac{1}{4} \left(\frac{\Delta R_1}{R_1} - \frac{\Delta R_2}{R_2} + \frac{\Delta R_3}{R_3} - \frac{\Delta R_4}{R_4} \right) \quad (1)$$

where v and U are output and input voltages, respectively. ΔR_1 , ΔR_2 , ΔR_3 and ΔR_4 are the resistance variations of the four resistors R_1 to R_4 , respectively.

The relationship between the relative change of a strain gauge and the strain is described as

$$\frac{\Delta R}{R} = k \cdot \varepsilon \quad (2)$$

where k is the gauge factor, which is about 2 for metal strain gauges. Substituting equation (2) into equation (1) for the four strains, we have

$$v = \frac{1}{4} \cdot k \cdot U \cdot (\varepsilon_1 - \varepsilon_2 + \varepsilon_3 - \varepsilon_4) \quad (3)$$

where $\varepsilon_1, \varepsilon_2, \varepsilon_3$ and ε_4 are strains of the four resistors R_1, R_2, R_3 and R_4 as shown in Figure 3, respectively. Equation (3) indicates that the base values of R_1, R_2, R_3 and R_4 are not important as long as gauge factors are equal.

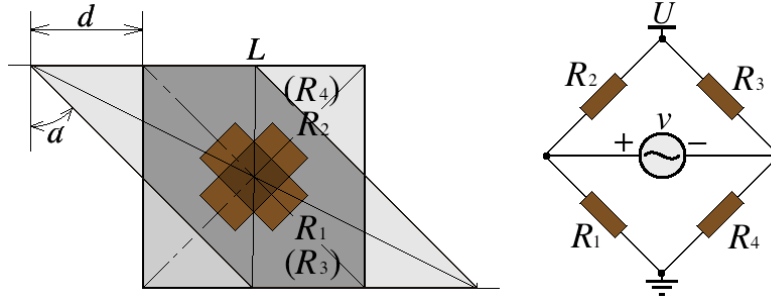

Figure 3: Schematic design of the bridge circuit: (a) Schematic shear distortion on the square component of the sensor, (b) Wheatstone bridge circuit

2.2.1. Shear Distortion

A relative displacement d along the x -axis shown in Figure 2, will deform the four strain gauges differentially due to the diagonal orientation, so that the relative displacement appears as shear distortion of the sensor. With four strain gauges deformed in diagonal orientations, we have the following relationship

$$\varepsilon = \varepsilon_1 = -\varepsilon_2 = \varepsilon_3 = -\varepsilon_4 \quad (4)$$

Substituting equation (4) into equation (3), the output voltage due to the shear distortion is

$$v = \frac{1}{4} \cdot k \cdot U \cdot (\varepsilon_1 - \varepsilon_2 + \varepsilon_3 - \varepsilon_4) = k \cdot U \cdot \varepsilon \quad (5)$$

From equation (3), the output voltage is linearly proportional to the strain ε and hence d for a given input voltage with a constant strain gauge factor. The supplying input voltage for the developed sensor is 2.5V in this study. A calibration test is necessary to find out the constant K in the following equation between measured strain and relative displacement

$$d = K \cdot \varepsilon \quad (6)$$

The sensor may actually suffer not only shear distortion, but also tension, compression, bending and torsion effects in real applications. In order to highlight the signal-to-noise ratio of the relative displacement measurements, it is desirable to minimize the sensor output due to tension, compression, bending and torsion effects.

2.2.2. Tension and Compression Effect

A tension or compression occurred along the x - or y -axis of the sensor as shown in Figure 2, will produce the same strain changes on all strain gauges, i.e.

$$\varepsilon = \varepsilon_1 = \varepsilon_2 = \varepsilon_3 = \varepsilon_4 \quad (7)$$

Then by equation (3), we have

$$v = \frac{1}{4} \cdot k \cdot U \cdot (\varepsilon_1 - \varepsilon_2 + \varepsilon_3 - \varepsilon_4) = 0 \quad (8)$$

This means that tension and compression of the sensor will produce no output.

2.2.3. Bending and Torsion Effect

When there is a bending effect along x -axis or a torsion effect rotating with x -axis direction, the following relationship on the strains can be derived based the symmetry of the design circuit with

$$\varepsilon_1 = \varepsilon_2, \quad \varepsilon_3 = \varepsilon_4 \quad (9)$$

The strains due to the bending effect along y -axis and the torsion effect rotating with y -axis have the following relationship

$$\varepsilon_1 = \varepsilon_4, \quad \varepsilon_2 = \varepsilon_3 \quad (10)$$

For the above mentioned cases, due to symmetry from equation (3), the output voltage due to the bending and torsion effect is zero as well.

As discussed, the arranged Wheatstone bridge circuit will only output a voltage due to shear distortion of the sensor with the effects of tension, compression, bending and torsion eliminated.

3. SENSOR CALIBRATION AND DATA ACQUISITION SYSTEM

This section describes the procedure used to identify the constant K in equation (6), and the data acquisition system used in the experimental test. Figure 4 shows that the sensor mounted on a rigid flat plate fully fixed at the bottom and allowed to slide at the top where a relative deformation is induced and measured by a micrometer. Figure 5 shows the introduced relative displacement on the sensor vs output micro-strain from the Wheatstone bridge. The slope, that is K , can be used to convert measured strain to relative displacement when installed on a structure.

Four relative displacement sensors were fabricated, and a National Instruments (NI) 9237 strain module with a NI compactDAQ USB Chassis 9174 were used for data acquisition.

4. APPLICATIONS TO STRUCTURAL HEALTH MONITORING

Numerous studies are conducted to perform damage detection by using wavelet analysis to identify the crack or stiffness change in structures. A perturbation or spike in the wavelet coefficients could

be observed in the wavelet transform diagram and it indicates the moment when the structural damage occurred (Hou et al. 2000, Wang and Deng 1999).

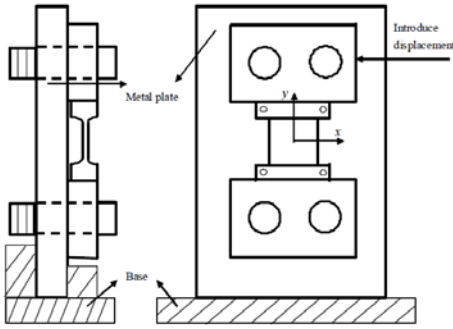

Figure 4: A platform used to calibrate the developed sensor

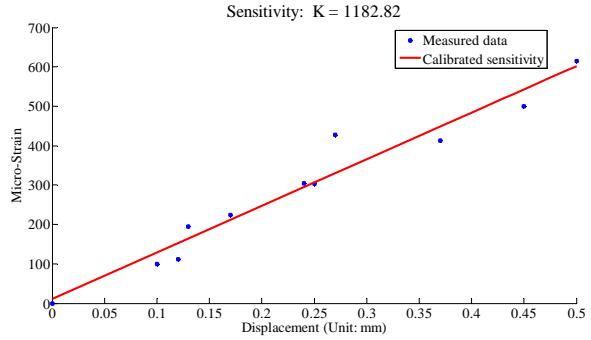

Figure 5: Calibration between strain and displacement

Many bridges are built as composite bridges in Australia with a short- or medium-span configuration. In such bridges, shear connections are provided to connect the slab and girders therefore the shear connections, e.g. shear connectors will resist the shear forces between slab and girders. The break or damage of shear connection will cause a significant shear slippage or spike in the relative displacement between the slab and girder.

4.1. A Computational Approach to Detect the Sudden Change in Relative Displacement

A computational approach has been proposed to detect the sudden change in signals (Canny 1986). In this study, a one-dimensional formulation with a sinusoidal filter is adopted. Let the impulse response of the filter be $f(x)$, and denote the measured response signal itself by $G(x)$. The convolution of the filter to the signal is given as

$$H_G = \int_{-W}^W G(x)f(x)dx \quad (11)$$

assuming the filter has a finite impulse response bounded by $[-W, W]$. To scale and visually see the detection results with the convolution, the following detector is defined to identify the sudden change in the measured signals.

$$H_D = \frac{\max(G(x))}{\max(H_G)} H_G \quad (12)$$

The detector H_D can be used to locate the sudden change with a local maximum, which is the moment when damage occurs in the measured signals.

5. DETECTING FAILURE OF SHEAR CONNECTORS IN A COMPOSITE BRIDGE

The above computational approach can be used to detect an inconspicuous sudden change or spike in a measured signal and it could be explored to identify the occurrence of relative displacement

change to monitor the conditions of shear connectors. Experimental studies to monitor the conditions of shear connectors in a composite bridge are conducted by using the developed relative displacement sensors.

5.1. Experimental Model

A composite bridge model was constructed with a concrete slab supported on two steel girders. Sixteen shear connectors were mounted with equal spacing in each girder to link the slab and steel girders. The bridge model was supported on two steel frames fixed to the laboratory strong floor as shown in Figure 6. The design of shear connectors allows for simulation of failure of specific shear links as well as for resetting to the undamaged state. Therefore, a bolt screwing into a nut cast in the slab was used to connect the slab and girder. If all bolts are engaged in the nuts and tightened the structure condition corresponds to the undamaged state. The damage of shear connectors is introduced into the structure by unscrewing several specific bolts to simulate the failure of shear links. Figure 7 shows the dimensions of the experimental testing model and the locations of relative displacement sensors noted as S1, S2, S3 and S4. The shear connectors connecting the slab and girder are denoted as SC1 to SC32.



Figure 6: (a) Experimental model;

(b) Mounted relative displacement sensors

5.2. Health Monitoring of Shear Connectors

The failure of shear connectors was simulated by releasing the bolt at location SC1 as the damage of shear connectors normally presents near the support locations because the shear forces at support locations are usually larger than other places. Figure 8 shows the detection results with the computational approach in Section 4.1. It can be found from Figure 8(a) that there is a big relative displacement change around 11s, which indicates the failure of shear connector SC1. The sudden change detected identifies the failure of shear connector clearly with an obvious local maximum at 11s and verifies that the developed relative displacement sensor can track the damage of shear connector. As can be seen from Figure 8(b) to (d), it is hard to find an outstanding maximum as the change in measured signals is not significant because these sensors are quite far away from the damage of SC1 and the relative displacements observed at S2, S3 and S4 sensors are around 0.002 mm and much smaller than that observed at S1 sensor which is about 0.04 mm.

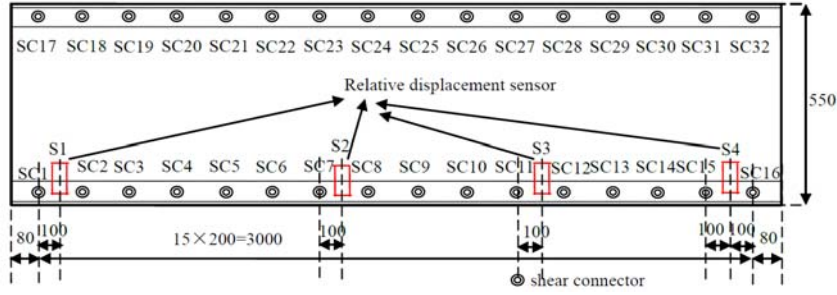

Figure 7: Locations of mounted relative displacement sensors

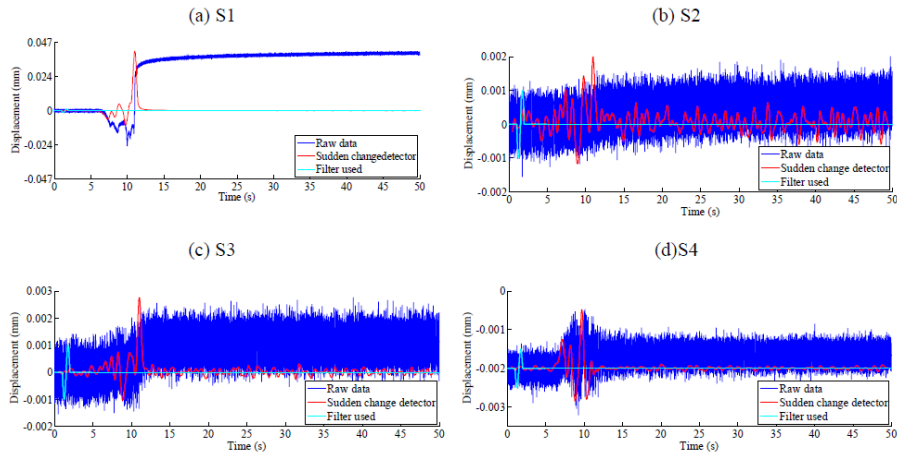

Figure 8: Detection results for the failure of shear connectors

5.3. Study on Sensitivity Radius for Health Monitoring

It has been observed from the above study that the developed relative displacement sensor can track the damage of shear connector, but the capability may be limited to local damage as such damage of shear connection is a local phenomenon. Therefore a study is conducted to investigate the sensitivity radius of the relative displacement sensor for condition monitoring of shear connectors in composite bridges.

In order to investigate the sensitivity radius of the relative displacement sensor S1 to detect the failure of shear connector, a series of tests with shear connectors SC2, SC4, SC6 and SC8 released respectively were conducted. The detection results are shown in Figure 13. The local maximum value in the recorded relative displacement decreases with the increase of the distance between the sensor and the damaged shear connector. Figure 9(a) shows there is a big sudden change in the observed relative displacement from S1 when there is a failure in SC2. When only releasing SC4 and SC6 in separate tests, Figure 9(b) and (c) shows that the sudden change can be observed but becoming insignificant. The relative displacement changes are as small as 0.004 mm compared with 0.035mm in Figure 9(a). Figure 9(d) shows the failure of SC8 occurs at 10s, and the detection result is not obvious with the maximum value almost close to the background relative displacement values. This observation makes sense because the relative displacement sensor measures the local

information and can only track the conditions of shear connectors locally. This sensitivity study shows that the developed relative displacement sensor can identify the conditions of shear connectors within a radius around 0.5m.

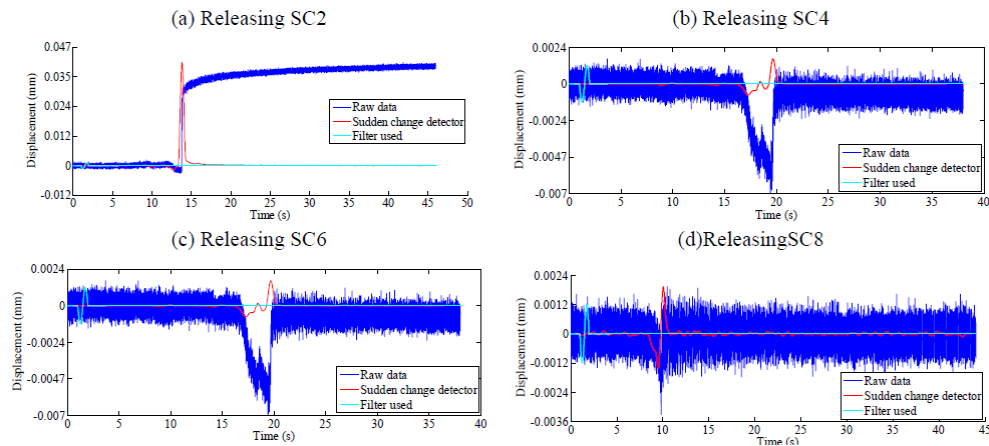

Figure 9: Study on the sensitivity radius of the developed sensor

6. CONCLUSIONS

This paper presents a developed relative displacement sensor for structural health monitoring. Relative displacement between two points on a structure, e.g., the slab and girder in this study, can be measured. The developed relative displacement sensor can be used to monitor the conditions of shear connectors in highway bridges as well as structural joints. The sensitive radius of the sensor to detect the deterioration of shear connectors is about 0.5m. The developed sensor is easy to be installed on bridge structures to detect shear connector conditions.

7. ACKNOWLEDGMENTS

The work described in this paper was supported by CIEAM II Project No. 3104 of the Australia Cooperative Research Centre for Integrated Engineering Asset Management (CIEAM) and University of Western Australia Research Collaboration Awards, "Energy Sustainable Wireless Sensor Network for Composite Bridge Health Monitoring".

REFERENCES

- Dilena M and Morassi A (2004). Experimental modal analysis of steel concrete composite beams with partially damaged connection. *Journal of Vibration and Control*. 10(6), pp. 897-913.
- Hou Z, Noori M and Amand R.St. (2000). Wavelet-based approach for structural damage detection. *Journal of Engineering Mechanics, ASCE*, 126(7), pp. 677-683.
- Nie J and Cai CS (2003). Steel-concrete composite beams considering shear slip effects. *Journal of Structural Engineering, ASCE*, 129(4), pp. 495-506.
- Wang Q and Deng X (1999). Damage detection with spatial wavelets. *International Journal of Solids and Structures*. 36(23), pp. 3443-3468.