

Copyright © 2012 IEEE. Personal use of this material is permitted. Permission from IEEE must be obtained for all other uses, in any current or future media, including reprinting/republishing this material for advertising or promotional purposes, creating new collective works, for resale or redistribution to servers or lists, or reuse of any copyrighted component of this work in other works.

Distribution Transformer Loading in Unbalanced Three-phase Residential Networks with Random Charging of Plug-In Electric Vehicles

Moayed Moghbel¹, Mohammad A.S. Masoum¹, Farhad Shahnia¹, Paul Moses²

¹Department of Electrical and Computer Engineering, Curtin University, Perth, WA, Australia.

²Propulsion and Energy Systems Group, Defence Science & Technology Organisation, Melbourne, VIC, Australia.

m.moghbel@yahoo.com, m.masoum@curtin.edu.au, farhad.shahnia@curtin.edu.au, paul.moses@dsto.defence.gov.au

Abstract- Utilization of plug-in electric vehicles (PEVs) is gaining popularity in recent years due to the growing concerns about fuel depletion and the increasing petrol price. Random uncoordinated charging of multiple PEVs in residential distribution feeders at moderate penetration levels are expected in the near future. The potential for stresses and network congestion is significant as PEV charging activities represent sizeable loads with unpredictable locations. Furthermore, the forthcoming smart grids will be unbalanced due to non-uniform distributions of PEVs in the three phases with unpredictable charging rates, times and durations. This paper explores the detrimental impacts of random PEV charging on the distribution transformer loading and bus voltage profiles of unbalanced smart grids. The impacts of non-uniform distributions of PEVs on the three phases, as well as deferred plugging of vehicles (encouraged by introducing higher electricity prices during the peak hours) are also explored. Simulation results will be generated and analyzed for an unbalanced three-phase 62 node residential network populated with PEV chargers using Matlab/Simulink software.

Index Terms- Plug-in electric vehicles, battery charging, unbalanced networks, distribution transformer, and smart grid.

I. INTRODUCTION

The number of plug in electric vehicles (PEVs) are rapidly growing as a result of oil and fossil fuel depletion and increasing petrol costs, as well as the high appetite to move toward a more sustainable environment. Meanwhile, due to lack of a coordinated charging regime, electric vehicles are plugged in and charged in an uncoordinated manner [1]. It is well known that random deployment and charging of PEVs in a distribution network causes many problems such as overloading of distribution transformers, bus voltage fluctuations and unbalanced loading [1-9]. In [2] it is estimated that PEVs market penetration in 2016 will be about 1.5 million and over 50 million in 2030. It was also estimated that PEVs penetration into market will lead to an annual increase of 2% in network load growth.

PEV coordination is a challenging demand side management problems [3-4] since their batteries represent sizeable loads that may lead to serious network stresses and overloads. Most researchers agree that the majority of PEV owners arrive home from work and start charging their vehicles within a very narrow time period that most likely coincides with the system's natural load peak demand [5]. This could stress the distribution network and result in degraded power quality, security and reliability [6-9].

In order to prepare for the rapid growth of PEV population and the installation of PEV charging stations, distribution networks must be upgraded and developed to support these new, sizable and unpredictable nonlinear loads. This requires long term research, careful planning and significant investment. A possible and expensive solution to solve the PEV charging problem is to update the distribution system by incorporating the PEV charging problem into automated demand side management techniques. With such techniques employed, the current distribution networks might be able to cope with these new demands.

This paper will investigate the impacts of PEVs charging on distribution network and will try to find a solution to reduce the negative impacts such as controlling the transformer loading and improving the network voltage profile. It will explore the effectiveness of mitigating the detrimental impacts caused by non-uniform distributions of PEVs on the three phases of the network by deferred plugging of vehicles, encouraged by introducing higher electricity prices during the peak hours. Simulation results including distribution transformer loading patterns, node voltages, line currents and voltage unbalanced factors will be generated and analyzed for a three-phase 62 node residential network with non-uniform distribution of PEVs in the single-phase residential feeders using Matlab/ Simulink software.

II. PROBLEM FORMULATION FOR PEV COORDINATION

Distribution transformers are commonly designed for specific load carrying capabilities based on typical or forecasted load consumption patterns. When PEVs are deployed, the normal electric power demand pattern will change and the power system might not be capable of handling the new operating conditions and demands. Based on recent studies [10-11], PEV owners may most often charge their vehicles soon after arriving home at early evening hours, which may cause an unexpected daily load peak around 6pm-10pm. Moreover, by deploying PEVs at residential houses, the average current unbalance will increase which could consequently result in undesired increase of voltage unbalance and causing problems to the power system especially distribution transformer.

A simple and practical approach to mitigate the detrimental impacts of PEV charging and reduce the burden on the distribution system is to encourage the consumers to shift their preferred charging times to off-peak hours by offering variable electricity pricing (Table I). This method of deferred PEV charging is explored here by allowing the consumers (PEV owners) to select their own preference start

charging times based on the variable electricity prices. They are encouraged to charge their electric vehicles during off-peak hours by defining three different tariffs based on the time of day (Table I). The most and least expensive charging time zones correspond to tariffs 1 and 3, respectively. With this arrangement, if a consumer is in hurry and wants his/her vehicle charged quickly, he/she will be charged at a high rate.

To quantify and investigate the degree of voltage unbalance, the voltage unbalanced factor (VUF) is defined as the ratio of the negative-sequence to the positive-sequence components of the unbalanced three-phase voltage [12]

$$\text{VUF} = \frac{\text{Negative sequence of three phase voltage}}{\text{Positive sequence of three phase voltage}} * 100 \quad (1)$$

where $V_1 = \frac{1}{3} * (V_a + xV_b + x^2V_c)$, $I_2 = \frac{1}{3} * (V_a + x^2V_b + xV_c)$, and $x = e^{j\frac{2\pi}{3}} = 1 + j120 \text{ deg}$.

TABLE I. PEVS OWNERS PREFERENCE OF CHARGING TIME

Tariff	Time of Day	Price Zone
1	6pm-10pm	Red zone (High tariff)
2	10pm-2am	Blue zone (Medium tariff)
3	2am-6am	Green zone (Low tariff)

III. THE 62 NODE UNBALANCED RESIDENTIAL NETWORK

The 62 bus unbalanced low voltage 415 V residential feeder connected to the high voltage system through 350 kVA 22/0.415 kV distribution transformer populated with PEVs (Fig. 1) will be simulated to test the effectiveness of the proposed deferred PEV charging. System, load and PEV data are listed in Appendix A. In this paper, a PEV penetration level of 50% (e.g., 30 vehicles per phase) is assumed. PEV locations and arrivals times are randomly generated and assigned; but kept unchanged for each simulation case study for consistency and proper comparison of results. A constant power factor of 0.95 is assumed for each household with an average house peak demand of 5.0 kW.

The vehicle specifications are obtained from typical PEV specifications [13] and the national transportation survey [14]. The battery capacity is 16 kWh and daily consumption of 8.75kWh is obtained from the 25 miles average daily commute distance and the PEV consumption rate of 34 kWh/100 miles. A 4 kW maximum rating per hour for PEV battery chargers that can be plugged into residential household supply is assumed with a unity power factor. This charger rating is within the capability of most modern day residential circuits and wiring standards (e.g., in Western Australia) which can typically supply 15 to 20 amps from a single phase 230 V supply.

IV. SIMULATION RESULTS AND DISCUSSIONS

Preliminary simulations for the 62 node unbalanced network of Fig. 1 are performed for different case studies listed in Table II. In all simulations, an unbalanced residential network with non-uniform distribution of PEVs over three phases are assumed and vehicles are supposed to be randomly

plugged in between 3:30 pm to 6:30 pm. The selected non-uniform distributions of PEVs are 53.3%, 30%, and 6.7% in phases A, B and C, respectively.

Fig.2 shows the network line currents of the 62 bus unbalanced low voltage residential feeder (Fig. 1) before deploying the PEVs. The rated line current is 487A. Note that the system is slightly unbalanced under normal operating conditions with no PEV charging due to the unbalanced residential loads.

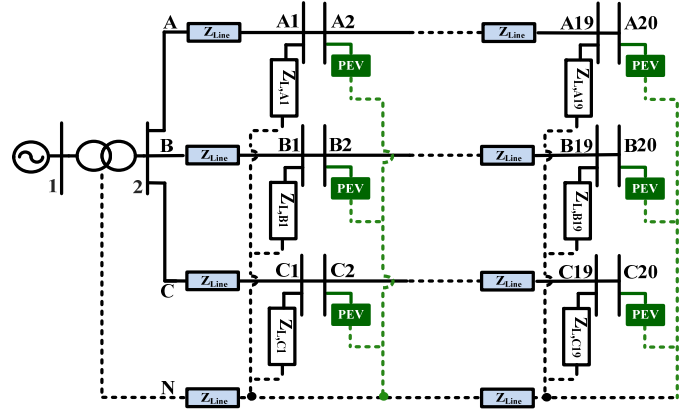

Figure 1. The 62 node unbalanced low voltage network with random plug-in time and non-uniform distribution of PEVs (53.3%, 30%, and 6.7% in phases A, B and C, respectively) in the three phases.

TABLE II. SIMULATED CASE STUDIES WITH DIFFERENT CONSUMER'S PREFERENCES FOR PEV CHARGING TIME FOR THE NETWORK OF FIG. 1

Case	Description
A	Random PEV charging- with no consumer preferences. PEVs are randomly plugged in and immediately charged with no delays.
B	Deferred PEV charging- with 20% of consumers preferring their vehicles to be charged in red time zone (Table I), 40% select blue time zone while the rest choose green time zone.
C	Deferred PEV charging- with 50% of consumers preferring their vehicles to be charged in blue time zone while the rest select green time zone.
D	Deferred PEV charging- with 70% of consumers preferring their vehicles to be charged in blue time zone while the rest select green time zone.

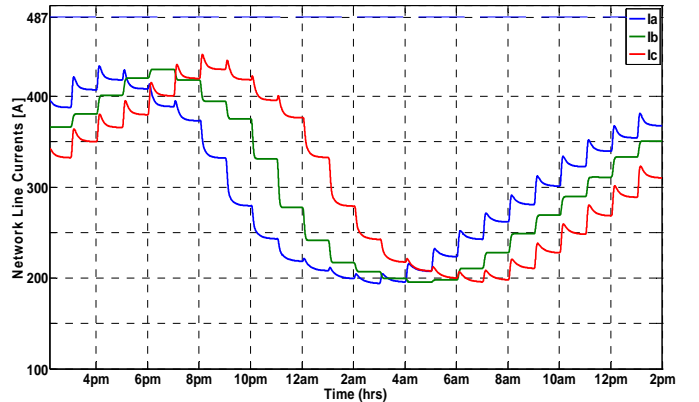

Figure 2. Distribution network line currents.

Case A. Random PEV charging with no consumer preferences

No deferred PEV charging is considered as all consumers prefer to charge their vehicles as soon as they arrive home. According to the simulation results of Fig. 3, with random charging of PEVs, the distribution network will face a number of operational problems especially during the peak load hours that most vehicles are randomly plugged in and charged. There will be overcurrent conditions in phases a and b beyond the rated value of 487A (Fig. 3a), distribution transformer overloading (around 15%, Fig. 3b) and voltage regulation problems with the worse bus voltage (node A20) dropping to 0.86 pu (Fig. 3c). Moreover, VUF (Eq. 1) is around 2.65% (Fig. 3d) which is above the standard value of 2% [15].

B. Deferred PEV charging considering consumer preferences (20% red zone, 40% blue zone, 40% green zone)

To explore the impacts of deferred PEV charging, consumer preferences (priorities) are considered. It is assumed that 20% of PEV owners need their vehicles charged quickly during the peak load hours, 40% prefer the blue time zone and the rest can wait until the morning hours. That is the PEV charger is equipped with a timer and can delay the charging as requested by the consumer.

Fig. 4 shows the simulation results indicating significant improvements compared with Case A. All three phase currents are now within the acceptable level below the rated value of 487A (Fig. 4a). Fig. 4b shows that by defining the tariffs, the peak demand period that was 4pm-10pm (Fig. 3b) is now distributed overnight and resulted in a significant reduction of transformer loading and limiting it below the rated value of 350kVA. The capacity of each battery is 16kWh requiring 4 hour to be fully charged. As a result, the last group of PEVs will finish charging at 6am. Consequently, transformer loading will be kept within its rated range. In addition, the VUF and worse node voltage profile will be also controlled as shown in Figs. 3c and 3d, respectively.

C. Deferred PEV charging considering consumer preferences (50% blue zone, 50% green zone)

This case is identical to Case B; however, consumer preferences are changed to 50% blue zone and 50% green zone. Simulation results are presented in Fig. 5 indicating that PEV charging activities are overnight. Figs. 5c and 5d illustrate that the VUF and worse node voltage profile are still acceptable and within their ranges. It can be seen that if most consumers choose the blue and green charging time zones, the problem of transformer overloading will be solved. However, the selections of time zones are totally controlled by the PEV owners and there is no guarantee that most of them choose the blue and green zones. The best approach may be offering cheap electricity during the off-peak hours.

D. Deferred PEV charging considering consumer preferences (70% blue zone and 30% green zone)

Fig. 6a shows that in this case the transformer will face overloading at around 10pm due to high penetration charging of PEVs within the blue zone. Fig. 6b, illustrates that in this

case the VUF over the 24 hour period is within the acceptable level less than 2%. Therefore, depend on the location of each PEV and the selected charging time zone, different operating conditions are possible and the results are not always perfect.

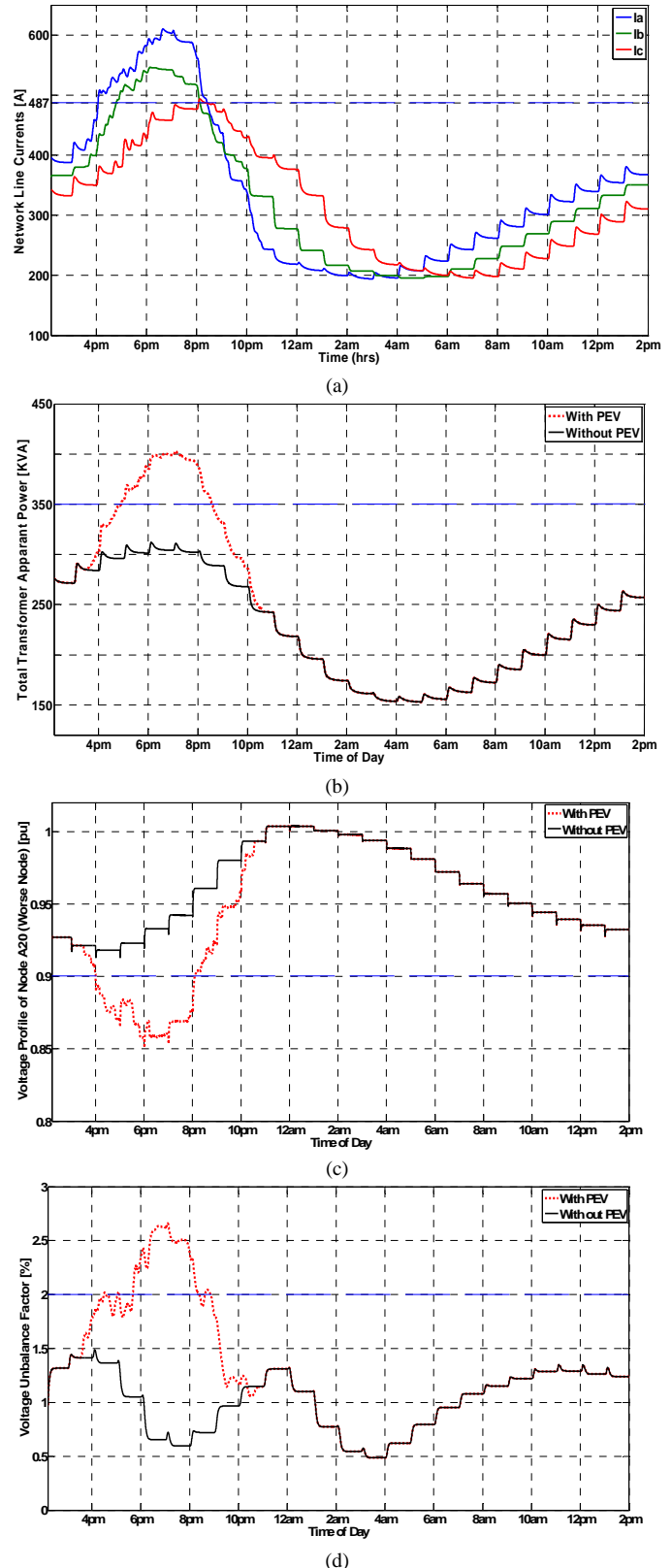
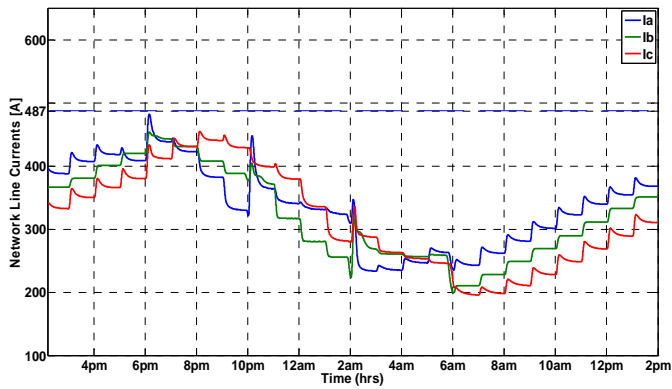
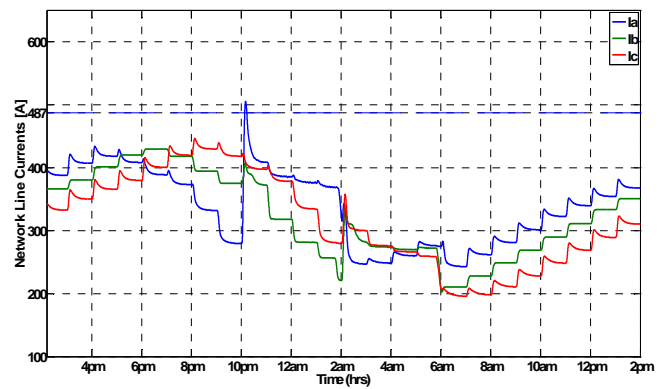

Figure 3. Simulation results for Case A; (a) network line currents, (b) total transformer apparent power, (c) worse node voltage profile (A20), (d) VUF.



(a)



(a)

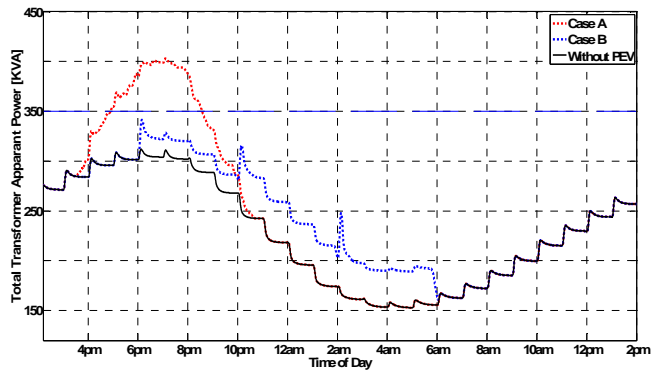

(b)

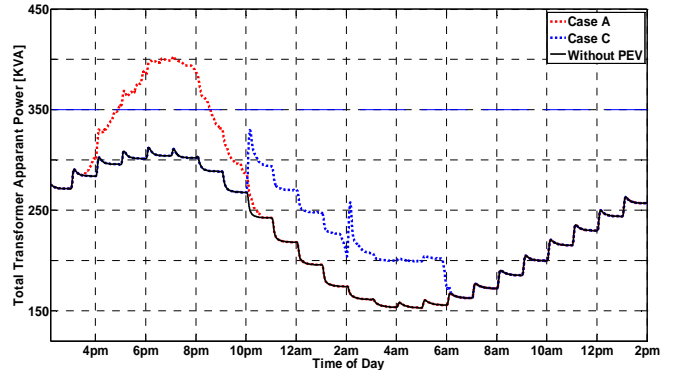

(b)

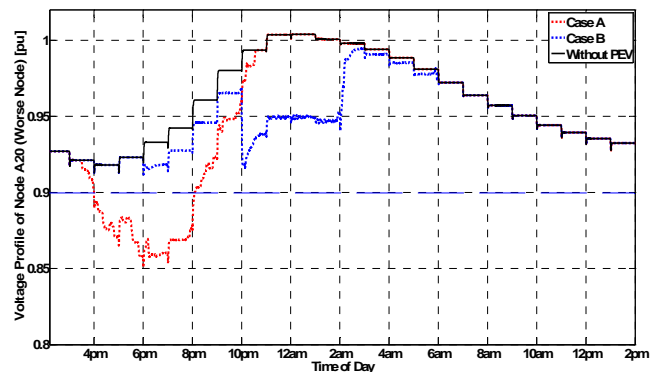

(c)

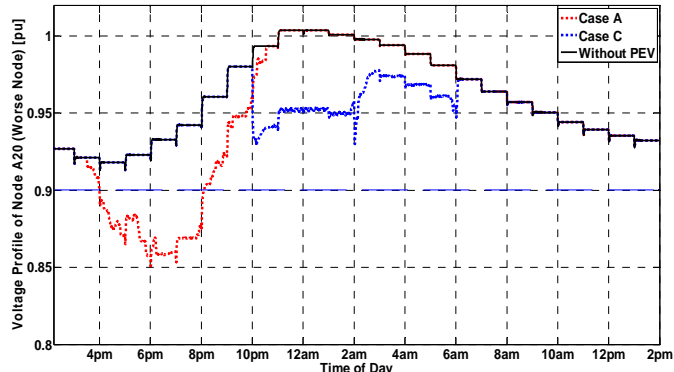

(c)

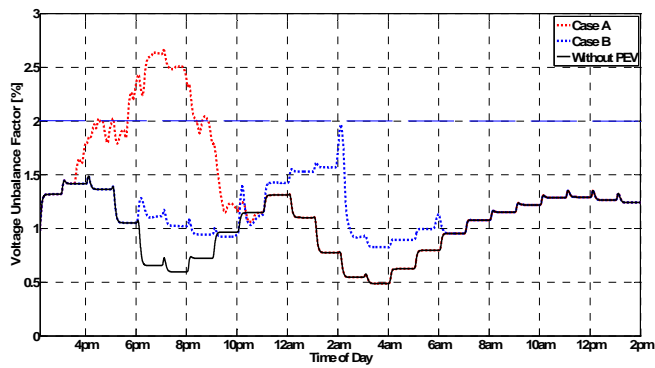

(d)

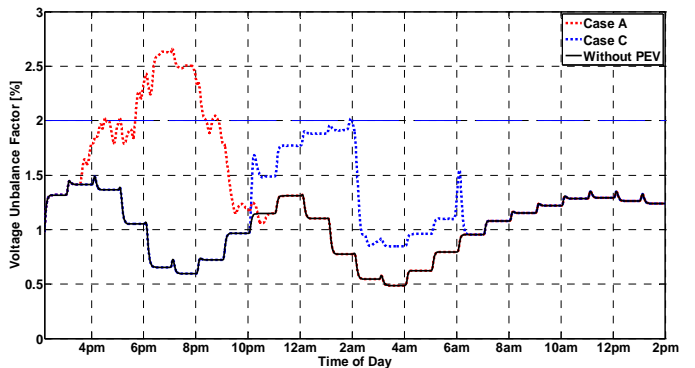

(d)

Figure 4. Simulation results for Case B; (a) network line currents, (b) total transformer apparent power, (c) worse node voltage profile (A20), (d) VUF.

Figure 5. Simulation results for Case C; (a) network line currents, (b) total transformer apparent power, (c) worse node voltage profile (A20), (d) VUF.

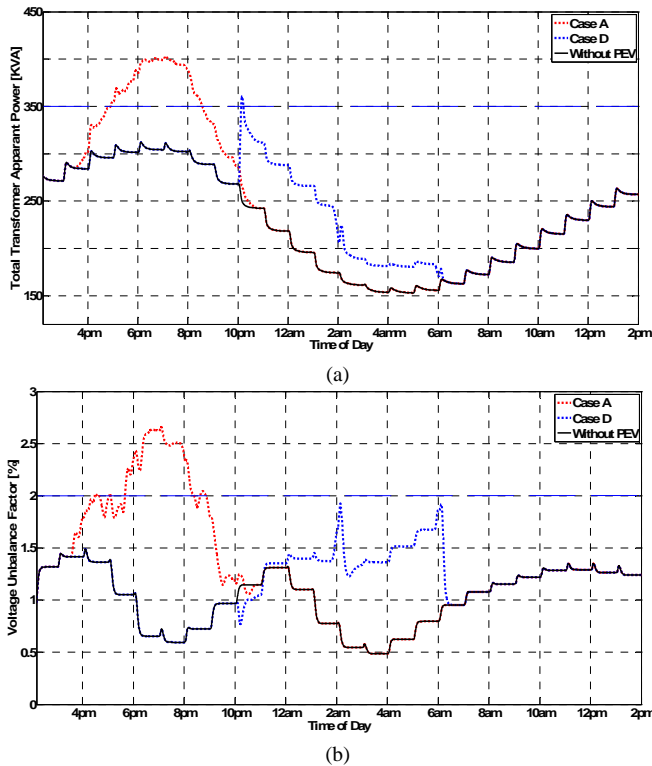

Figure 6. Simulation results for Case D; (a) network line currents, (b) total transformer apparent power, (c) worse node voltage profile (A20), (d) VUF.

V. CONCLUSION

This paper highlights the detrimental impacts of random PEV charging on unbalanced distribution network with non-uniform distributions of PEVs on the single-phase residential feeders. A simple and practical PEV charging control scheme is evaluated that considers consumer preferences for charging time zones and encourages off-peak charging activities by offering variable electricity pricing. Detailed simulation results are presented for a three-phase 62 node residential network with non-uniform distribution of PEVs in the single-phase residential feeders. The main conclusions are:

- With random charging of PEVs, the distribution network will face operational problems such as overcurrent conditions, distribution transformer overloading, poor voltage regulation and unacceptable VUF.
- Deferred PEV charging based on consumer preferences will generally improve system performance. However, depending on the location of each PEV and the selected charging time zone, different operating conditions are possible and the results are not always acceptable.
- Deferred PEV charging is simple, inexpensive and practical. However, the selections of time zones are totally controlled by the PEV owners and there is no guarantee that they choose to shift their charging activities to off-peak hours.

VI. REFERENCES

[1]. P.S. Moses, M.A.S. Masoum and S. Hajforoosh, "Overloading of distribution transformers in smart grid due to uncoordinated charging of plug-In electric vehicles," Innovative Smart Grid Technologies (ISGT), 2012 IEEE PES, pp.1-6, Jan. 2012.

[2] New York ISO. Alternate route: electrifying the transportation sector, Technical report. NY: New York ISO; 2009.

[3] A. S. Masoum, S. Deilami, P. S. Moses, M. A. S. Masoum, and A. Abu-Siada, "Smart load management of plug-in electric vehicles in distribution and residential networks with charging stations for peak shaving and loss minimization considering voltage regulation," IET Proc. Gener., Transm., Distrib, vol. 5, no. 8, pp. 877–888, 2011.

[4] T. Gönen, Electric Power Distribution System Engineering. Boca Raton, FL: Taylor & Francis, 2007.

[5] S. Deilami, A.S. Masoum, P.S. Moses, and M.A.S. Masoum, "Real-Time Coordination of Plug-In Electric Vehicle Charging in Smart Grids to Minimize Power Losses and Improve Voltage Profile," Smart Grid, IEEE Transactions on , vol.2, no.3, pp.456-467, Sept. 2011

[6] F. Shahnia, A. Ghosh, G. Ledwich, and F. Zare, "Voltage Unbalance Sensitivity Analysis of Plug-in Electric Vehicles in Distribution Networks," Australian Universities Power Engineering conf. (AUPEC), Brisbane, Sep. 2011.

[7] A. R. Metke and R. L. Ekl, "Security technology for smart grid networks," IEEE Transactions on Smart Grid, vol. 1, no. 1, pp. 99-107, 2010.

[8] P. S. Moses, S. Deilami, A. S. Masoum, and M. A. S. Masoum, "Power quality of smart grids with plug-in electric vehicles considering battery charging profile," in IEEE PES Conference on Innovative Smart Grid Technologies Europe, Chalmers Lindholmen, Gothenburg, Sweden, 2010, pp. 1-7.

[9] A. Ipakchi and F. Albuyeh, "Grid of the future," IEEE Power and Energy Magazine, vol. 7, no. 2, pp. 52-62, 2009.

[10] S. Hadley and A. Tsvetkova, "Potential Impacts of Plug-in Hybrid Electric Vehicles on Regional Power Generation," ORNL/TM-2007/150, January 2008.

[11] Battelle Energy Alliance, "U.S. Department of Energy Vehicle Technologies Program – Advanced Vehicle Testing Activity Plug-in Hybrid Electric Vehicle Charging Infrastructure Review," Final Report, November 2008.

[12] R.C. Dugan, M.F. McGranaghan, and H.W. Beaty, "Electrical Power Systems Quality" (McGraw-Hill, 1996)

[13] U. E. P. Agency. (2011) 2011 electric vehicles, fuel economy. [Online]. Available: <http://www.fueleconomy.gov/feg/evsbs.shtml>

[14] P. Hu and T. Reuscher. (2004, Dec.) Summary of travel trends. U.S. Department of Transportation and Federal Highway Administration.[Online]. Available: <http://nhts.ornl.gov/2001/pub/STT.pdf>

[15] "Australian Standard Voltage, AS60038-2000," ed, 2000.

Appendix A

Table A1
DISTRIBUTION TRANSFORMER DATA

DESCRIPTION	DATA
Rated primary voltage	22 kV
Rated secondary voltage	415 V
Operating frequency	50 Hz
Rated load capacity	350 kVA
Primary winding resistance	0.00055 pu
Secondary winding resistance	0.00055 pu
Primary leakage inductance	0.01 pu
Secondary leakage inductance	0.01 pu

Table A2
PEV specifications

Description	Data
Battery capacity	16 kWh
Energy usage per 100 miles	34 kWh
Average daily commute distance	25 milws
Daily consumption	8.75 kWh

Table A3
PEV Charging and Household Loads (Fig. 1)

Linear and PEV Loads		Power	
Node	Type	[kW]	[kVAR]
(A1-A20), (B1-B20), (C1-C20)	Linear Loads	5.0	1.643
Selected residential nodes	PEV Charger	4.0	0

Table A4
Randomly selected PEV, location Plug In Times and Phase Name

PEV Number	Plug In Time	Location	Zone (Case B)
1	16:30	A1	Blue
2	15:39	B1	Green
3	16:30	A2	Green
4	17:12	A3	Red
5	16:51	B3	Green
6	15:45	A4	Green
7	15:57	A5	Red
8	16:15	B5	Green
9	16:42	B6	Red
10	18:00	A7	Blue
11	16:36	B7	Green
12	15:48	A8	Red
13	17:30	A9	Blue
14	16:00	A10	Blue
15	17:45	C9	Red
16	16:09	A11	Blue
17	3:30	A12	Blue
18	17:18	C11	Green
19	16:48	A13	Red
20	17:27	B13	Blue
21	17:45	B14	Blue
22	16:21	A15	Green
23	17:33	A16	Blue
24	16:36	C15	Green
25	17:48	A18	Blue
26	15:57	B17	Green
27	18:06	C18	Green
28	18:12	A20	Blue
29	16:24	B19	Blue
30	17:00	C20	Green



Moayed Moghbel (S'11) received his B.S. degree in Electrical Engineering from Khomeinishahr Azad University, Isfahan, Iran in 2003. He has four years of industrial experience in a petrochemical company as an electrical maintenance engineer and one year as a distribution project manager. His interests include power quality, protection and electrical machines.



Mohammad A.S. Masoum (S'88–M'91–SM'05) received his B.S., M.S. and Ph.D. degrees in Electrical and Computer Engineering in 1983, 1985, and 1991, respectively, from the University of Colorado at Boulder, USA. Currently, he is an Associate Professor and the discipline leader for Power System Engineering at the Electrical and Computer Engineering Department, Curtin University, Perth, Australia. Dr. Masoum is the co-author of *“Power Quality in Power Systems and Electrical Machines”* (Elsevier, 2008) and *“Power Conversion of Renewable Energy Systems”* (Springer, 2011). He is a senior member of IEEE. renewable energy systems.



Farhad Shahnia received his B.Sc. and M.Sc. in Electrical Power Engineering with first class honour from University of Tabriz, Tabriz, Iran in 2004 and 2006, respectively and his Ph.D. Electrical Engineering from Queensland University of Technology, Brisbane, Australia in 2011. He is currently a lecturer in Curtin University, Perth, Australia. His professional experience includes three years at Research Office-Eastern Azarbayjan Electric Power Distribution Company, Tabriz, Iran. Prior to joining Curtin University, he was a research fellow in Queensland University of Technology, Brisbane, Australia. His fields of interest include Distribution Networks, Power Quality and Application of Power Electronic in Power Systems.



Paul S. Moses (S'09) received his B.Eng. (1st Class Hons.) and B.S. degrees in Electrical Engineering and Physics in 2006 from Curtin University, Perth, Australia. He was awarded an Australian Postgraduate Award scholarship in 2009 and is presently working towards a Ph.D. degree in Electrical Engineering at Curtin University, Perth, Australia. Since 2007, he is also working as a Research Scientist for the Defence Science and Technology Organisation (DSTO), Department of Defence, HMAS Stirling, Australia, and is presently part of their Maritime Platforms Division, Propulsion and Energy Systems Group. His research interests include nonlinear electromagnetic phenomena, power quality and protection.