

# Accepted Manuscript

Effect of crumb rubber on mechanical properties of multi-phase syntactic foams

Thong M. Pham, Jim Kingston, Gary Strickland, Wensu Chen, Hong Hao

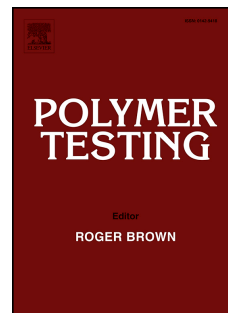

PII: S0142-9418(17)31374-0

DOI: [10.1016/j.polymertesting.2017.12.033](https://doi.org/10.1016/j.polymertesting.2017.12.033)

Reference: POTE 5285

To appear in: *Polymer Testing*

Received Date: 24 September 2017

Revised Date: 6 November 2017

Accepted Date: 30 December 2017

Please cite this article as: T.M. Pham, J. Kingston, G. Strickland, W. Chen, H. Hao, Effect of crumb rubber on mechanical properties of multi-phase syntactic foams, *Polymer Testing* (2018), doi: 10.1016/j.polymertesting.2017.12.033.

This is a PDF file of an unedited manuscript that has been accepted for publication. As a service to our customers we are providing this early version of the manuscript. The manuscript will undergo copyediting, typesetting, and review of the resulting proof before it is published in its final form. Please note that during the production process errors may be discovered which could affect the content, and all legal disclaimers that apply to the journal pertain.

# Effect of Crumb Rubber on Mechanical Properties of Multi-phase Syntactic Foams

Thong M. Pham<sup>1</sup>, Jim Kingston<sup>2</sup>, Gary Strickland<sup>2</sup>, Wensu Chen<sup>1</sup> and Hong Hao<sup>1\*</sup>

<sup>1</sup>Center for Infrastructural Monitoring and Protection, School of Civil and Mechanical Engineering, Curtin University, Kent Street, Bentley, WA 6102, Australia

<sup>2</sup>Matrix Composites & Engineering, 150 Quill Way, Henderson, WA 6166, Australia

\*Corresponding author's email: hong.hao@curtin.edu.au

## Abstract

Syntactic foam is a lightweight and strong material which can be used in marine and aeronautical applications. However, the brittleness of the material limits its application to a broader range. Adding crumb rubber to the syntactic foam can increase its energy absorption capacity. The effect of crumb rubber on the fracture toughness and energy absorption capacity of 2-phase and 3-phase syntactic foam is evaluated under both static and impact loads. The experimental results have shown that the fracture toughness of the 2-phase rubberized syntactic foam increased by 8% while an increase of 22% of its fracture energy was observed. Under quasi-static loads, the 3-phase rubberized syntactic foam showed decreases in the compressive strength and elastic modulus but an increase in the energy absorption capacity as compared to the syntactic foam without crumb rubber. In addition, the impact energy absorption of the 3-phase rubberized syntactic foam increased by 24% as compared to that of the 3-phase syntactic foam without crumb rubber.

**Keywords:** Syntactic foam; Impact behaviour, Energy absorption; Fracture toughness; Crumb rubber.

## 23 1. Introduction

24 Syntactic foam is a type of lightweight and rigid composite material, which consists of binder  
25 and fillers. The binder matrix can be made of polymeric resin, metal and ceramic [1] and the  
26 fillers are in forms of microsphere and macro-sphere, which are made from rigid materials  
27 such as glass, carbon, metal, ceramic, cenosphere and polymeric materials [2]. The syntactic  
28 foams are commonly categorized as 2-phase and 3-phase [3]. It is noted that this classification  
29 is based on the main compositions of the material regardless the additive (e.g. crumb rubber).  
30 Traditional foam is mainly made of binder matrix with relatively low compressive strength.  
31 Therefore, microspheres are mixed with binder matrix to form the 2-phase syntactic foam. 3-  
32 phase syntactic foam is made of microspheres mixed binder matrix dispersed with macro-  
33 spheres, which can be gaseous voids or hollow spheres [4]. The macro-sphere, as reinforcing  
34 filler of syntactic foam, can be made of spheres coated with fibre reinforced epoxy. For  
35 instance, Wu et al. [3] developed a macro-sphere by coating Expanded Polystyrene (EPS)  
36 beads with carbon fibre reinforced epoxy using rolling ball method.

37 The superior mechanical properties of the syntactic material can be obtained through the  
38 composite action [5-7]. It should be noted that the effect of the volume fraction of  
39 microsphere on the mechanical properties of syntactic foam is not well understood [8, 9].  
40 Swetha and Kumar [2] found that the strength of the foam decreased with the increase of  
41 microsphere content. Its energy absorption capacity kept increasing with the rising content of  
42 microsphere up to 40% and then decreased. Kim and Khamis [10] observed that the  
43 increasing volume fraction of the microsphere in the microsphere epoxy resin composites  
44 improved its impact performance while decreased the fracture toughness and flexural strength.  
45 However, Wouterson et al. [11] reported the opposite testing observations, i.e., the presence  
46 of microsphere increased the fracture toughness but decreased the impact resistance capacity

47 of syntactic foam. The strain rate effect of syntactic epoxy foam material has been  
48 investigated under ambient temperature [12-14]. The strain rate effect of expanded  
49 polystyrene foam under high temperature has been also investigated [15]. The failure strength  
50 of polyurethane foam exhibited nonlinear strain-rate dependency [16, 17]. To improve the  
51 mechanical properties, crumb rubber has been added into syntactic foam [18-20]. The rubber  
52 can enhance impact energy absorption through elastic deformation of rubber and preventing  
53 micro-cracks from developing into macro-cracks. It is noted that replacing the microspheres  
54 by the crumb rubber can increase the energy absorption capacity but slightly decrease the  
55 compressive strength [21]. Bagheri and Pearson [21] found that using 10% of crumb rubber is  
56 the optimal value. Further volume fraction of crumb rubber (e.g. 15%) showed a reduction in  
57 the fracture toughness. Maharsia et al. [18] found the presence of 2% rubber particles (40-75  
58  $\mu\text{m}$ ) by volume quantity increased the flexural strength and energy absorption of syntactic  
59 foam. Bagheri et al. [22] conducted a critical review of the effect of crumb rubber on the  
60 fracture toughness of 2-phase syntactic foam and found that the optimal value of the crumb  
61 rubber volume fraction ranges between 10% and 20%.

62 The syntactic material can find applications owing to its characteristics of thermal efficiency,  
63 lightweight and high compressive strength and toughness [23, 24]. The syntactic foam  
64 material has been intensively employed for marine applications including deep-water  
65 exploration, which needs to withstand enormous water pressure while provide sufficient  
66 buoyancy [3, 25]. Sandwich structure made of two thin stiff face-sheets and various thick  
67 cores is used to absorb energy and resist loads. The cores can be made of lightweight  
68 materials such as metal foam, polymer foam and lattice materials etc. For instance, the  
69 syntactic foam material with aluminium matrix can be used as protection system in military  
70 vehicles to withstand blast and impact loads and protect the passengers [26]. The material has  
71 the potential for infrastructural protection of vehicle roadside barrier as energy absorption

72 device, which can effectively reduce the impact force [27]. In addition, the lightweight  
73 material can be used to protect the offshore structure against ship impact and underwater  
74 impact of the pipeline caused by dropping objects. By considering its great potential for  
75 impact applications, the behaviours of syntactic foam under impact are worth studying.  
76 However, the research on the dynamic response of syntactic material subjected to impact  
77 loading is limited and some contradicted findings pertaining to the presence and volume  
78 fraction of microsphere on the mechanical properties of syntactic foam were reported.

79 This study experimentally investigates the behaviours of four types of syntactic materials,  
80 associated with/without crumb rubber and with (3-phase)/without (2-phase) macro-spheres,  
81 subjected to quasi-static and impact loads. The fracture toughness and static/impact energy  
82 absorption of the syntactic foams are experimentally investigated.

## 83 **2. Production of the syntactic foam**

### 84 **2.1. *Composition and properties of materials***

85 Four types of syntactic foam are investigated in this study. They are classified into 2-phase  
86 and 3-phase syntactic foams and which are further divided into two types of white (without  
87 crumb rubber) and black (with crumb rubber) materials. The 2-phase syntactic foam includes  
88 epoxy and glass microspheres ( $\sim 50 \mu\text{m}$  diameter) with/without crumb rubber. The syntactic  
89 foam without crumb rubber is named as white material while the one with crumb rubber is  
90 called black material. Carbon fibre reinforced macro-spheres ( $\sim 10 \text{ mm}$  diameter) were added  
91 to the 2-phase syntactic foam to form 3-phase syntactic foam.

92 The carbon fibre reinforced macro-spheres had the diameter of 10 mm as presented in Fig. 1.  
93 The macro-spheres were coated with carbon fibre to significantly improve their compressive  
94 strength. The macro-sphere production is usually a commercial secret of a marine equipment

95 production company. The epoxy and glass microspheres were supplied by Matrix [28]. The  
96 glass microspheres appear as free flowing white powder to naked eyes. They were made of  
97 Borosilicate glass with the density ranging from  $100 \text{ kg/m}^3$  to over  $1000 \text{ kg/m}^3$ . The average  
98 diameter of the glass microspheres is approximately  $50 \mu\text{m}$ . The crumb rubber was produced  
99 from recycled car tyres so that it was a mixture of different blends of rubbers and fillers. A  
100 laser diffraction particle size test was conducted on the crumb rubber according to ISO 13320  
101 [29]. The distribution of crumb rubber particle size is presented in Fig. 2. The composition of  
102 these component materials is presented in Table 1. The volume fraction of the crumb rubber  
103 of 15% was decided after conducting a review of its optimal value as presented in the  
104 previous study [22]. The compressive strength and modulus of the Matrix epoxy were 100  
105 MPa and 2750 MPa, respectively. The density of the white and black 2-phase syntactic foam  
106 was  $770$  and  $920 \text{ kg/m}^3$ , respectively.

## 107 **2.2. Production of samples**

108 The production of the 2-phase syntactic foam is well presented in the previous study [22] so  
109 that this section does not repeat the production process and only describes the procedure of  
110 manufacturing the 3-phase syntactic foam. The required amount of carbon fibre reinforced  
111 macro-spheres (60% packing density) was put into a steel mould with the size of  $100 \text{ mm} \times$   
112  $200 \text{ mm}$ . It is noted that a random packing of spheres is based on the previous study by He et  
113 al. [30]. If the close random packing is applied for equal particles, the packing density  
114 approaches 63% [30]. Due to a high surface-area-to-volume ratio of these specimens, the  
115 packing density in this study was approximately 60%. The mixture of the binder was prepared  
116 from the Matrix epoxy blend and Matrix glass microspheres with/without crumb rubber.  
117 There were two types of the binder used in this study, including the white and black binders.  
118 The black binder contained crumb rubber while the white binder did not. The binder was then

119 injected into the mould in a vacuum condition. The mixture was cured at 80°C overnight,  
120 followed by a post cure at 130°C for 2 hours. The production process of the samples is  
121 presented in Fig. 3. The density of the 3-phase syntactic foam for the black and white  
122 specimens was approximately 501 kg/m<sup>3</sup> and 419 kg/m<sup>3</sup>, respectively.

### 123 2.3. *Microstructure*

124 To check the syntactic foam structure, two different techniques were carried out, which  
125 included a Nikon SMZ800 stereomicroscope with a Schott KL1500LCD light source and  
126 scanning electron microscope (SEM). The Toupcam UCMOS 14000KPA digital camera  
127 associated with ToupView 3.7 software was used to capture the images. The microstructure of  
128 the 2-phase syntactic foam is presented in Fig. 4. There was only micro-sphere particles in the  
129 white specimen as shown in the left picture. Meanwhile, there were two types of particles in  
130 the black material including glass micro-spheres and rubbers as shown in the right picture.  
131 The twinkling particles represent glass micro-spheres and the grey particles stand for crumb  
132 rubber. The composition of the particles and the even distribution of the crumb rubber and  
133 other particles are shown in Fig. 4. The bonding between particles and binder plays an  
134 essential role in the structural performance of the material. Thus, the rough surface of the  
135 macro-sphere is to increase the bonding between the binder and the macro-spheres as shown  
136 in Fig. 5. The roughness of the surface is found to be significant for improving the bonding  
137 between binder and particles [8, 31, 32]. The interface bonding between the macro-spheres  
138 and the binder is examined after tests and presented in the later part.

## 139 3. Fracture Toughness Testing

### 140 3.1. *Specimens and testing apparatus*

141 The fracture toughness tests were conducted on the 2-phase syntactic foam including white  
 142 (without crumb rubber) and black (with crumb rubber) materials. Two slabs were prepared  
 143 using a PTFE lined steel mould with dimension of 300 mm long x 200 mm wide x 45 mm  
 144 deep. Ten notched beams were prepared for each type of material as presented in Fig. 6. Each  
 145 face of the specimens was milled square and parallel to create 20 mm x 40 mm x 180 mm  
 146 cuboids, followed by a second milling process to form the slot. The apparatus and testing  
 147 procedure comply with ASTM D5045 [33]. All specimens were stored in the laboratory to  
 148 equilibrate to standard laboratory conditions for at least 3 weeks. Immediately prior to testing,  
 149 a final “sharp” crack was formed at the tip of the slot by resting the cutting edge of a “box  
 150 cutter” knife along the length of the slot and applying a moderate pressure by hand. It is noted  
 151 that there was no cutting or scoring motions were applied. An indentation test was carried out  
 152 for each material to identify the compliance of the test apparatus and the proportion of the  
 153 strain energy developed in each test that could be attributed to the indentation by the rollers.

### 154 3.2. Results and discussions

155 The experimental results from the fracture toughness tests are respectively presented in Tables  
 156 2 and 3 for the white and black materials, respectively. It is noted that the energy correction  
 157 due to the indentation of the rollers was measured as 0.019 and 0.034 J for the white and  
 158 black materials, respectively. In general, the specimens failed at a cross head deflection of  
 159 0.75 mm with the loading rate of 10 mm/min [33]. To ensure the validity of the tests, the size  
 160 of the specimen is chosen so that the yield stress must be greater than the minimum yield  
 161 stress.

$$\begin{aligned}
 \sigma_{\min} &= K_{Ic} \sqrt{\frac{2.5}{W-a}} = 9.7 \text{ MPa} \quad \text{for white material} \\
 &= 10.4 \text{ MPa} \quad \text{for black material}
 \end{aligned}
 \tag{1}$$



163 where  $\sigma_{\min}$  is the minimum yield stress,  $K_{Ic}$  is the plane-strain fracture toughness, and  $W$  and  $a$   
 164 are the dimensions of the specimen presented in Fig. 6. The fracture toughness or critical  
 165 stress intensity factor ( $K_{Ic}$ ) and the critical strain energy release rate ( $G_{Ic}$ ) are determined as  
 166 follows [33]:

$$167 \quad K_{Ic} = \frac{P_Q}{B\sqrt{W}} f(x) \quad (2)$$

$$168 \quad G_{Ic} = \frac{U}{BW\phi} \quad (3)$$

169 where  $P_Q$  is the force determined based on ASTM D5045 [33],  $B$  is the thickness of the  
 170 specimen shown in Fig. 6,  $f(x)$  is the function of the ratio between the crack length and the  
 171 specimen depth,  $\phi$  is the energy calibration factor, and  $U$  is the corrected energy. The  
 172 corrected energy ( $U$ ) results from subtracting the energy-to-peak by the energy caused by the  
 173 indentation displacement.

174 As presented in Tables 2-3, the average critical stress intensity factors or fracture toughness  
 175 ( $K_{Ic}$ ) for the white and black materials are 0.864 and 0.933 MPa $\sqrt{m}$ , respectively. The  
 176 increase of the critical stress intensity factor of the black material was about 8% as compared  
 177 to the white material. The mean values of the critical strain energy release rate ( $G_{Ic}$ ) of the  
 178 white and black material are 0.332 and 0.404 kJ/m<sup>2</sup>, respectively. It results in an increase by  
 179 22% in the critical strain energy release rate of the black material as compared to the white  
 180 one. As expected, replacing the microspheres by crumb rubber increases the fracture  
 181 toughness and the critical strain energy release rate of the materials. The results are consistent  
 182 with previous studies [2, 10].

183 It is worth mentioning that micro-length scale damage is more beneficial to the energy  
 184 absorption than macro-length scale damage. For instance, several micro-cracks may absorb  
 185 the same amount of energy as one macro-crack. The macro-crack may fragment the material

186 while the micro-cracks may only degrade the structural capacity and modulus. Therefore,  
 187 preventing the development of the micro-cracks into the macro-cracks is the key factor to  
 188 improve the fracture toughness and ductility of the material. Adding crumb rubber was found  
 189 to result in the crack bridging phenomenon which improves the fracture toughness [18].  
 190 However, the increase of the fracture toughness in this study is not significant. As presented  
 191 in the study by Bagheri et al. [22], the optimal volume fraction of crumb rubber needs to be  
 192 identified and the authors recommended the searching range was from 10% to 20% of the  
 193 volume fraction. More trial fracture toughness tests should be conducted to determine the  
 194 optimal value of the volume fraction of the crumb rubber suggested between 10% and 15%.

195 In addition, there are many uncertainties introduced in this procedure so that it needs to be  
 196 verified. ASTM D5045 [33] recommended the value of  $E/(1-\nu^2)$  derived by two different  
 197 methods can be cross checked:

$$198 \quad \frac{E}{(1-\nu^2)} = \frac{K_{Ic}^2}{G_{Ic}} \quad (4)$$

$$199 \quad \frac{E}{(1-\nu^2)} = \frac{\Psi}{B(C_Q - C_i)} \quad (5)$$

200 where  $\nu$  and  $E$  are the Poisson's ratio and tensile modulus of the material, respectively;  $C_Q$   
 201 and  $C_i$  are the compliance from the fracture tests and the indentation test, respectively; and  $\Psi$   
 202 is the calibration factor. As recommended by ASTM D5045 [33], the value estimated from  
 203 Eq. 4 should be larger, and the difference is recommended to be less than 15%. As calculated,  
 204 the differences determined by two different methods are 7.6% and 16.7% for the white and  
 205 black materials, respectively.

206 The findings in this study are consistent with those from the previous study [18]. Maharsia et  
 207 al. [18] observed that there was no significant difference in the modulus and stiffness of the

208 rubberized syntactic foam (adding 2% crumb rubber) and the plain syntactic foam. The  
209 authors found an approximately 18% increase in the fracture strain with the addition of crumb  
210 rubber.

#### 211 **4. Compressive behaviour under quasi-static loads**

212 The 3-phase syntactic foam was created to have light weight and relatively high strength and  
213 energy absorption capacity, thus, its compressive behaviour under static and impact loads was  
214 investigated. The Baldwin machine with the capacity of 600 kN was used to carry out the  
215 compression tests on the 3-phase syntactic foam. The loading rate was maintained at 0.5  
216 mm/min until the specimens failed. The loading rate was carried out to comply with AS  
217 1012.9 [34] for compressive strength tests. The specimens were machined at two ends to  
218 ensure full contact between the loading heads and the specimens. The cylindrical specimens  
219 were 100 mm in diameter and 200 mm in height. The applied load and displacement of the  
220 specimens were measured by the embedded load cell and linear variable differential  
221 transformer in the machine.

222 The tested specimens failed by some major cracks as presented in Fig. 7. The arbitrary failure  
223 surface of the tested specimens was observed rather than an approximately typical  $45^\circ$  failure  
224 surface in normal concrete. This figure shows the failure surfaces intersected carbon fiber  
225 reinforced macro-spheres. Failure of the interface between the binder and the macro-spheres  
226 was found at only one macro-sphere. In general, the interface bonding was sufficient. All the  
227 macro-spheres in the failure surface were damaged. As a result, the failure of the macro-  
228 spheres also governs the failure of the specimens. This failure mode was also observed in the  
229 previous study [3]. Since the binder and the macro-sphere govern the failure, adding crumb  
230 rubber in the binder, which is not a huge volume fraction, may not considerably affect the

231 strength and energy absorption of the material. As a result, the behaviour of the white and  
232 black materials did not show a significant difference.

233 The stress-strain curves of the tested cylinders are presented in Fig. 8. The stress-strain curves  
234 of the syntactic foam increase linearly up to about 12 MPa with the corresponding strain of  
235 1.7%. The stress-strain curves of the tested specimens dropped along with the specimens  
236 failure, showing a very brittle manner, which is different from those reported by Wu et al.  
237 [3]. The 3-phase syntactic foam in the study by Wu et al. [3] failed in a more ductile manner,  
238 where the specimens reached the maximum stress at the strain of 5% and then the stress  
239 significantly dropped. As shown in Fig. 8, the slope of these curves started to decrease after  
240 reaching 12 MPa and the white and black specimens reached the maximum stresses of 16.5  
241 and 15.5 MPa, respectively. Adding crumb rubber led to 6% reduction in the compressive  
242 strength of the rubberized syntactic foam as compared to the white one. The axial strains  
243 corresponding to the maximum stresses of the white and black specimens were 2.9% and  
244 3.1%, respectively. The energy absorption, defined by the area under the force-displacement  
245 curves of the two specimens are 0.37 and 0.39 kN·m for the white and black materials,  
246 respectively. The energy absorption of the black specimen was about 5.4% higher than that of  
247 the white material. The two specimens did not show a considerable difference in the static  
248 behaviour. It shows that replacing 15% volume fraction of the glass microspheres by the  
249 crumb rubber does not significantly change the static behaviour of the specimens. The elastic  
250 modulus of the syntactic foam for the white and black specimens is 748 and 627 MPa,  
251 respectively.

252 In addition, the microstructure of the material was examined after the compression tests and  
253 presented in Fig. 9. Observation of cracks in the black material specimens was difficult so that  
254 cracks in the white material specimen are presented herein. Two types of damage modes were

255 found in the specimen. A separation at the interface between the binder and the macro-sphere  
256 is presented in Fig. 9a. This crack is connected with another one cutting through the binder as  
257 shown in Fig. 9b. The crack in the binder shows both damages of the epoxy resin and glass  
258 micro-sphere. The crack in the binder was stopped at the macro-sphere. The failure  
259 mechanism helps to improve the ductility and thus the energy absorption performance, which  
260 demonstrated the effectiveness of coating macro-spheres. This mechanism was also observed  
261 in the previous study for micro-spheres [20].

## 262 **5. Compressive behaviour under impact loads**

### 263 *5.1. Test setup and data acquisition system*

264 The impact testing apparatus as shown in Fig. 10 was used to carry out drop-weight impact  
265 tests. A cylindrical steel projectile weighing 97.5 kg was dropped from 3 m height onto the  
266 top of the tested cylinders. This drop generated a kinetic energy of 2.87 kJ. The projectile was  
267 designed to have a smooth flat bottom with a radius  $r = 50$  mm. A plastic guiding tube was  
268 utilized to ensure the projectile falling vertically to the targets. A load cell was placed at the  
269 bottom of the specimens to measure the impact force. A high-speed camera which was set to  
270 capture 20000 frames per second was used to monitor the failure process. The data acquisition  
271 system controlled by a computer was used to record signals from the load cell. The data  
272 acquisition system recorded data at a sampling rate of 1 MHz. This sampling rate was adopted  
273 according to the recommendation from a previous study [35]. Pham and Hao [35] investigated  
274 the sampling rate on the results of the axial impact tests. The authors recommended that the  
275 sampling rate smaller than 100 kHz may not be able to capture peak impact load and  
276 responses.

### 277 *5.2. Test results and discussions*

278 The high speed camera was used to monitor the failure while the image analysis was utilized  
279 to derive the displacement of the specimens. The both white and black cylinders failed in an  
280 explosive manner when the top half of the specimens was smashed. This failure mode is  
281 different from that of concrete cylinders in which the splitting failure was observed [35] (see  
282 Fig. 11). This is because the tensile properties of the syntactic foam are governed by the  
283 epoxy resin which has much higher tensile strength than that of concrete. As a result, the  
284 syntactic foam failed by crushing of the compressive material rather than splitting as in  
285 concrete. The progressive failure of the white specimen is shown in Fig. 12. Spalling of the  
286 white syntactic foam at the top started at about 0.8 ms after the impact. A vertical crack  
287 initiated at the impacted end propagated downward and became visible at 1 ms. The white  
288 specimen was severely smashed in a very brittle manner at 2.35 ms. Meanwhile, the black  
289 specimen did not exhibit damage up to 1 ms after the impact. At 1.45 ms, the black specimen  
290 showed significant damage in the top half. The failure modes of the two specimens showed  
291 similar manner, which indicates using 15% volume fraction crumb rubber did not  
292 considerably reduce the brittleness of the material.

293 The impact force time histories of the two specimens are presented in Figs. 13-14. During the  
294 impact event, the projectile may impact the specimens one or multiple times depending on the  
295 projectile-specimen interaction. It is noted that the time scale of the impact force measured by  
296 a load cell and those from the high speed camera are not synchronized. For the white  
297 specimen, the projectile first impacted the specimen so that the projectile and the top surface  
298 of the specimen moved with two different velocities in the same direction. They then lost  
299 contact in a very short period of approximate 35 ms before being in contact again as shown in  
300 Fig. 13. The impact force of the white specimen reached the maximum value at the second  
301 peak of 372 kN. The impulses of the first and second impacts of the white specimen are 136  
302 and 602 kN·ms, respectively. The duration of the first and the second impacts of the white

303 specimen was 1 ms and 5 ms, respectively. The impact force of the black specimen reached  
304 the peak of 231 kN with the corresponding duration of 1 ms, resulting in the impulse of 138  
305 kN·ms (Table 4). It can be concluded that the white material can withstand higher impact  
306 force and impulse than the black material. The impulse of the impact force is defined as a  
307 measure of the impact resistance capacity of the tested specimens. The replacement of glass  
308 microsphere by crumb rubber decreased the impact impulse capacity of syntactic foam.

309 In this study, the impact energy absorption is estimated based on the energy conservation law  
310 in which the impact velocity and the residual velocity of the projectile were traced from the  
311 image processing technique. As shown in Fig. 15, the two specimens had similar impact  
312 velocities (6.76 m/s) but the black specimen exhibited a lower residual velocity than that of  
313 the white specimen (5.96 m/s vs 6.33 m/s). As a result, the black specimen absorbed 1136 J  
314 while the energy absorption of the white specimen was 915 J as shown in Fig. 16. The impact  
315 energy absorption of the material was about 3 times its energy absorption under static loads as  
316 shown in Table 4. In this study, replacing glass microspheres by crumb rubber leads to 24%  
317 increase of the impact energy absorption while the energy absorption enhancement under  
318 static load was only 5%. This increase agrees with the testing results by Li and John [20] in  
319 which they found that rubberized syntactic foam with 20% volume fraction had a higher  
320 capacity to absorb impact energy and resist bending strength via the positive composite action  
321 between glass microsphere and crumb rubber. The co-existence of stiff particles (i.e. glass  
322 microsphere) and soft particles (i.e. crumb rubber) can adjust and reduce stress concentration.  
323 As reported, the initiation energy (i.e. elastic strain energy absorption) increased by replacing  
324 a portion of glass microspheres by crumb rubber, which proved the positive effect of adding  
325 crumb rubber.

326 In addition, the specific energy absorption of these specimens were observed as 583 kJ/m<sup>3</sup> for  
327 the white foam and 723 kJ/m<sup>3</sup> for the black foam. The specific energy of the syntactic foam in

328 this study was about 10 times smaller than that of the hollow glass microsphere/epoxy based  
329 syntactic foam ( $6-15 \text{ MJ/m}^3$ ) reported by Swetha and Kumar [2]. This difference is reasonable  
330 since the compressive strength of the syntactic foam in the study by Swetha and Kumar [2]  
331 was approximately 6 times stronger than that of the syntactic foam in this study. Meanwhile,  
332 Walter et al. [36] reported the similar energy absorption of epoxy-based syntactic foam  
333 ranging from  $200 - 2000 \text{ kJ/m}^3$  when materials with similar strength were used. Therefore,  
334 the glass microspheres partially replaced by the crumb rubber yielded higher energy  
335 absorption but lower impact impulse capacity. Adding crumb rubber to the syntactic foam can  
336 increase the energy absorption but reduce the compressive strength of the material. This may  
337 be due to the fact that at a high volume fraction of crumb rubber, not much epoxy is available  
338 for bonding the matrix and transferring stresses prior to fracture. In addition to examine the  
339 dynamic increase factor, the compressive stresses of the specimens are presented in Figs. 17-  
340 18. As shown in these figures, the material is strain rate sensitive as the compressive stress of  
341 these specimens was approximately double their static strengths. This increase reasonably  
342 agrees with the experimental results reported by Zhang et al. [6] in which split Hopkinson  
343 pressure bar was used to investigate the dynamic properties of syntactic foam with hollow  
344 glass spheres. The authors observed the dynamic increase factor from 1.2 to 2.2 in varied  
345 strain rates from  $0.01 \text{ s}^{-1}$  to  $2750 \text{ s}^{-1}$ . It is noted that accurate strain measure could not be  
346 achieved with the drop-weight tests so that better equipment (e.g. split Hopkinson pressure  
347 bar) should be used to further investigate the strain rate effect on the mechanical properties of  
348 the syntactic foam.

### 349 **5.3. Microstructure investigation**

350 Unlike the specimens under the static tests, macro-spheres coated by fibre became brittle  
351 under impact loads, which was also observed in the previous study [35]. Pham and Hao [35]



352 presented that carbon and glass fibre show very brittle behaviour under impact loads, and  
353 glass fibre performs much better than carbon fibre due to its high rupture strain. Fig. 19 shows  
354 the failure of the white specimen at the interface and a macro-sphere while this failure was not  
355 seen in the rubberized specimen. The macro-sphere was broken in the plane at an angle to the  
356 failure surface during the impact event, indicating the brittleness of macro-spheres. This  
357 failure indicates the white binder can transfer a sufficiently higher stress to a macro-sphere as  
358 compared to the black binder. It is noted that the coated macro-spheres for the rubberized  
359 specimen did not show damage in the angled plane respect to the failure surface. In general,  
360 adding crumb rubber did not show a significant difference of the material properties under  
361 static loads but it resulted in a considerable change under impact loads as shown in Figs. 13-  
362 14, indicating it is sensitive to impact loads. This phenomenon also indicates that the white  
363 specimen is able to absorb more energy than the rubberized specimen due to more damage  
364 occurred in macro-spheres as evident in the impact tests.

365 In addition, the quality of the bonding between crumb rubbers and the epoxy is very important  
366 to the material performance. Kaynak et al. [37] observed poor bonding and separation  
367 between the crumb rubbers from waste tyres while Maharsia et al. [18] found a good bonding  
368 between the crumb rubbers and the epoxy. A sound bonding between the crumb rubber and  
369 epoxy was found in this study.

## 370 **6. Conclusions**

371 Replacing 15% volume fraction of the glass microsphere by the crumb rubber slightly  
372 increases energy absorption capacity of the syntactic foam under quasi-static loads but not  
373 impact loads. The density of the 3-phase syntactic foam is about 25% of that of normal  
374 strength concrete but it has a similar fracture toughness.

375 For the 2-phase syntactic foam, introducing 15% volume fraction of the crumb rubber slightly  
376 increases the fracture toughness (8%) and the fracture energy (22%). More trial fracture  
377 toughness tests should be conducted to determine the optimal value of the volume fraction of  
378 the crumb rubber between 10% and 15%.

379 For the 3-phase syntactic foam under quasi-static loads, the compressive strength and elastic  
380 modulus of the rubberized syntactic foam reduces by 6% and 16.1%, respectively. The energy  
381 absorption capacity of the black material increases by 5.1% as compared to the white material.  
382 The volume fraction of the crumb rubber is recommended to be reduced for a better  
383 performance on the energy absorption of the 3-phase syntactic foam.

384 The impact impulse resistance of the 3-phase rubberized syntactic foam is inferior as  
385 compared to the 3-phase syntactic foam without crumb rubber. However, the impact energy  
386 absorption of the 3-phase rubberized syntactic foam increased by 24% as compared to that of  
387 the syntactic foam without crumb rubber.

388 In summary, the optimal volume fraction of crumb rubber may fall between 10% and 15%.  
389 When 3-phase syntactic foam is introduced, it should have lower volume fraction of crumb  
390 rubber as compared to that in 2-phase syntactic foam. The optimal values depend on 2-phase  
391 or 3-phase syntactic foam and static or dynamic loading conditions.

### 392 **Acknowledgement**

393 The support from Australian Research Council via Discovery Early Career Researcher Award  
394 (DE160101116) is acknowledged.

395 **References**

- 396 [1] Shutov FA. Syntactic polymer foams. *Chromatography/Foams/Copolymers*: Springer;  
397 1986. p. 63-123.
- 398 [2] Swetha C, Kumar R. Quasi-static uni-axial compression behaviour of hollow glass  
399 microspheres/epoxy based syntactic foams. *Materials & Design*. 2011;32(8-9):4152-63.
- 400 [3] Wu X, Dong L, Zhang F, Zhou Y, Wang L, Wang D, Yin Y. Preparation and  
401 characterization of three phase epoxy syntactic foam filled with carbon fiber reinforced  
402 hollow epoxy microspheres and hollow glass microspheres. *Polym Compos*. 2016;37(2):497-  
403 502.
- 404 [4] Narkis M, Kenig S, Puterman M. 3-Phase syntactic foams. *Polym Compos*.  
405 1984;5(2):159-65.
- 406 [5] Lapčík L, Ruzsala MJA, Vašina M, Lapčíková B, Vlček J, Rowson NA, Grover LM,  
407 Greenwood RW. Hollow spheres as nanocomposite fillers for aerospace and automotive  
408 composite materials applications. *Composites Part B: Engineering*. 2016;106:74-80.
- 409 [6] Zhang X, Wang P, Zhou Y, Li X, Yang E-H, Yu TX, Yang J. The effect of strain rate and  
410 filler volume fraction on the mechanical properties of hollow glass microsphere modified  
411 polymer. *Composites Part B: Engineering*. 2016;101:53-63.
- 412 [7] Gupta N, Ye R, Porfiri M. Comparison of tensile and compressive characteristics of vinyl  
413 ester/glass microballoon syntactic foams. *Composites Part B: Engineering*. 2010;41(3):236-  
414 45.
- 415 [8] Huang R, Li P. Elastic behaviour and failure mechanism in epoxy syntactic foams: The  
416 effect of glass microballoon volume fractions. *Composites Part B: Engineering*. 2015;78:401-  
417 8.
- 418 [9] Porfiri M, Gupta N. Effect of volume fraction and wall thickness on the elastic properties  
419 of hollow particle filled composites. *Composites Part B: Engineering*. 2009;40(2):166-73.
- 420 [10] Kim HS, Khamis MA. Fracture and impact behaviours of hollow micro-sphere/epoxy  
421 resin composites. *Composites Part A: Applied Science and Manufacturing*. 2001;32(9):1311-  
422 7.
- 423 [11] Wouterson EM, Boey FYC, Hu X, Wong S-C. Fracture and Impact Toughness of  
424 Syntactic Foam. *Journal of Cellular Plastics*. 2004;40(2):145-54.
- 425 [12] Song B, Chen WW, Lu WY. Mechanical characterization at intermediate strain rates for  
426 rate effects on an epoxy syntactic foam. *International Journal of Mechanical Sciences*.  
427 2007;49(12):1336-43.
- 428 [13] Li P, Petrinic N, Siviour CR, Froud R, Reed JM. Strain rate dependent compressive  
429 properties of glass microballoon epoxy syntactic foams. *Materials Science and Engineering*:  
430 A. 2009;515(1-2):19-25.
- 431 [14] Koohbor B, Mallon S, Kidane A, Lu W-Y. The deformation and failure response of  
432 closed-cell PMDI foams subjected to dynamic impact loading. *Polym Test*. 2015;44:112-24.
- 433 [15] Krundaeva A, De Bruyne G, Gagliardi F, Van Paepegem W. Dynamic compressive  
434 strength and crushing properties of expanded polystyrene foam for different strain rates and  
435 different temperatures. *Polym Test*. 2016;55(Supplement C):61-8.
- 436 [16] Whisler D, Kim H. Experimental and simulated high strain dynamic loading  
437 of polyurethane foam. *Polym Test*. 2015;41(Supplement C):219-30.
- 438 [17] Weißenborn O, Ebert C, Gude M. Modelling of the strain rate dependent deformation  
439 behaviour of rigid polyurethane foams. *Polym Test*. 2016;54(Supplement C):145-9.
- 440 [18] Maharsia R, Gupta N, Jerro HD. Investigation of flexural strength properties of rubber  
441 and nanoclay reinforced hybrid syntactic foams. *Materials Science and Engineering: A*.  
442 2006;417(1-2):249-58.

- 443 [19] Li G, Jones N. Development of rubberized syntactic foam. *Composites Part A: Applied*  
444 *Science and Manufacturing*. 2007;38(6):1483-92.
- 445 [20] Li G, John M. A crumb rubber modified syntactic foam. *Materials Science and*  
446 *Engineering: A*. 2008;474(1):390-9.
- 447 [21] Bagheri R, Pearson RA. Role of particle cavitation in rubber-toughened epoxies: 1.  
448 *Microvoid toughening*. *Polymer*. 1996;37(20):4529-38.
- 449 [22] Bagheri R, Marouf B, Pearson R. Rubber-toughened epoxies: a critical review. *Journal of*  
450 *Macromolecular Science®, Part C: Polymer Reviews*. 2009;49(3):201-25.
- 451 [23] Gibson L, Ashby M. *Cellular solids: structure and properties*. Cambridge: Cambridge  
452 University Press; 2003.
- 453 [24] Nasim M, Brasca M, Khosroshahi SF, Galvanetto U. Understanding the impact  
454 properties of polymeric sandwich structures used for motorcyclists' back protectors. *Polym*  
455 *Test*. 2017;61(Supplement C):249-57.
- 456 [25] Le Gall M, Choqueuse D, Le Gac P-Y, Davies P, Perreux D. Novel mechanical  
457 characterization method for deep sea buoyancy material under hydrostatic pressure. *Polym*  
458 *Test*. 2014;39(Supplement C):36-44.
- 459 [26] Altenaiji M, Guan ZW, Cantwell WJ, Zhao Y, Schleyer GK. Characterisation of  
460 aluminium matrix syntactic foams under drop weight impact. *Materials & Design*.  
461 2014;59:296-302.
- 462 [27] Kim HS, Oh HH. Manufacturing and impact behavior of syntactic foam. *J Appl Polym*  
463 *Sci*. 2000;76(8):1324-8.
- 464 [28] Matrix. Syntactic foam. <http://www.matrixengineered.com/>. Accessed on 2<sup>nd</sup> November  
465 2017.
- 466 [29] ISO 13320. *Particle Size Analysis: Laser Diffraction Methods: International*  
467 *Organization for Standardization*; 2009.
- 468 [30] He D, Ekere N, Cai L. Computer simulation of random packing of unequal particles.  
469 *Physical review E*. 1999;60(6):7098.
- 470 [31] Licitra L, Luong DD, Strbik Iii OM, Gupta N. Dynamic properties of alumina hollow  
471 particle filled aluminum alloy A356 matrix syntactic foams. *Materials & Design*. 2015;66,  
472 Part B:504-15.
- 473 [32] Taherishargh M, Belova IV, Murch GE, Fiedler T. On the mechanical properties of heat-  
474 treated expanded perlite–aluminium syntactic foam. *Materials & Design*. 2014;63:375-83.
- 475 [33] ASTM D5045. *Standard test methods for plane-strain fracture toughness and strain*  
476 *energy release rate of plastic materials*. D5045:2014. West Conshohocken, PA2014.
- 477 [34] AS 1012.9. *Compressive strength tests - concrete*. 10129: 2014. Sydney, NSW,  
478 Australia2014.
- 479 [35] Pham TM, Hao H. Axial Impact Resistance of FRP-Confined Concrete. *J Compos*  
480 *Constr*. 2017;21(2):04016088.
- 481 [36] Walter T, Sietins J, Moy P. Evaluation of Syntactic Foam for Energy Absorption at Low  
482 to Moderate Loading Rates. *Advanced Composites for Aerospace, Marine, and Land*  
483 *Applications II*: Springer; 2015. p. 233-44.
- 484 [37] Kaynak C, Sipahi-Saglam E, Akovali G. A fractographic study on toughening of epoxy  
485 resin using ground tyre rubber. *Polymer*. 2001;42(9):4393-9.

486 **List of Figures**

487 Figure 1. Component materials

488 Figure 2. Crumb rubber particle size distribution

489 Figure 3. Production of 3-phase syntactic foam

490 Figure 4. Microstructure of 3-phase syntactic foam

491 Figure 5. Micrograph of the interface between macro-sphere and binder

492 Figure 6. Fracture toughness tests – apparatus and specimens

493 Figure 7. Failure of 3-phase syntactic foam under quasi-static load

494 Figure 8. Stress-strain curves of 3-phase syntactic foam under quasi-static load

495 Figure 9. Micro-cracks under static tests

496 Figure 10. Drop-weight test apparatus

497 Figure 11. Failure modes of different materials

498 Figure 12. Progressive failure of 3-phase syntactic foam under impact tests

499 Figure 13. Impact force time history of white material

500 Figure 14. Impact force time history of black material

501 Figure 15. Velocity of the specimens under impact tests

502 Figure 16. Impact energy absorption of the 3-phase specimens

503 Figure 17. Compressive stress of the 3-phase white specimen under impact load

504 Figure 18. Compressive stress of the 3-phase black specimen under impact load

505 Figure 19. Micro-cracks of the 3-phase white specimen under impact tests

506 **List of Tables**

507 Table 1. Composition of component materials

508 Table 2. Experimental results of fracture toughness tests for the white material

509 Table 3. Experimental results of fracture toughness tests for the black material

510 Table 4. Experimental results of 3-phase syntactic foam

1 Table 1. Composition of component materials

	Material	Volume fraction of matrix (%)			Macro spheres (packing density)
		Epoxy blend	Glass microspheres	Crumb rubber (75 $\mu\text{m}$ )	
2-phase	White syntactic foam	64	36	nil	nil
	Black syntactic foam	64	21	15	nil
3-phase	White syntactic foam	64	36	nil	60%
	Black syntactic foam	64	21	15	60%

2

1 Table 2. Experimental results of fracture toughness tests for the white material

No.	Ligament width (mm)	Width (mm)	Crack length (mm)	Peak force (N)	$K_{Ic}^a$ (MPa $\sqrt{m}$ )	Energy to peak (Nm)	Corrected energy (Nm)	$G_{Ic}^b$ (kJ/m <sup>2</sup> )
1	20.1	40.2	20.10	304	0.809	0.073	0.054	0.272
2	20.2	40.0	19.80	331	0.873	0.086	0.067	0.337
3	20.2	39.9	19.70	311	0.81	0.071	0.052	0.260
4	20.2	40.1	19.90	338	0.876	0.093	0.074	0.363
5	20.1	40.0	19.90	317	0.839	0.084	0.065	0.325
6	20.1	40.2	20.10	336	0.894	0.098	0.079	0.395
7	20.1	40.2	20.10	349	0.928	0.098	0.079	0.397
8	20.1	40.1	20.00	331	0.869	0.081	0.062	0.307
9	20.2	40.1	19.90	349	0.909	0.096	0.077	0.382
10	20.1	40.0	19.90	313	0.828	0.075	0.056	0.283
Mean		40.1	19.9	328	0.864	0.086	0.067	0.332
SD		0.1	0.14	15.9	0.041	0.010	0.010	0.051

2 <sup>a</sup> Critical stress intensity factor3 <sup>b</sup> Critical strain energy release rate



1 Table 3. Experimental results of fracture toughness tests for the black material

No.	Ligament width (mm)	Width (mm)	Crack length (mm)	Peak force (N)	$K_{Ic}^a$ (MPa $\sqrt{m}$ )	Energy to peak (Nm)	Corrected energy (Nm)	$G_{Ic}^b$ (kJ/m <sup>2</sup> )
1	20.2	40.2	20.0	342	0.889	0.117	0.083	0.408
2	20.1	40.2	20.1	379	1.013	0.126	0.092	0.464
3	20.0	40.2	20.2	354	0.935	0.107	0.073	0.362
4	20.3	40.2	19.9	370	0.954	0.124	0.090	0.443
5	20.1	40.2	20.1	347	0.919	0.109	0.075	0.377
6	20.2	40.2	20.0	327	0.850	0.097	0.063	0.312
7	20.1	40.1	20.0	369	0.974	0.124	0.090	0.447
8	20.1	40.1	20.0	345	0.920	0.113	0.079	0.397
9*	20.2	40.3	20.1	362	0.944	0.122	0.088	0.432
Mean		40.2	20.0	355	0.933	0.115	0.081	0.404
SD		0.1	0.1	16.4	0.047	0.010	0.010	0.048

2 \* Data of specimen no. 10 was lost

3 <sup>a</sup> Critical stress intensity factor4 <sup>b</sup> Critical strain energy release rate

1 Table 4. Experimental results of 3-phase syntactic foam

Testing condition	Characteristic	White foam	Black foam
Static load	Compressive strength (MPa)	16.5	15.5
	Elastic modulus (MPa)	748	627
	Energy absorption (kJ)	0.37	0.39
Impact load	Peak impact force (kN)	295/372*	231
	Impact duration (ms)	1/5*	1
	Impact impulse (kN.ms)	136/602*	138
	Energy absorption (kJ)	0.92	1.14
	Specific energy (kJ/m <sup>3</sup> )	583	723

2 \* Results corresponding to the first and second peaks

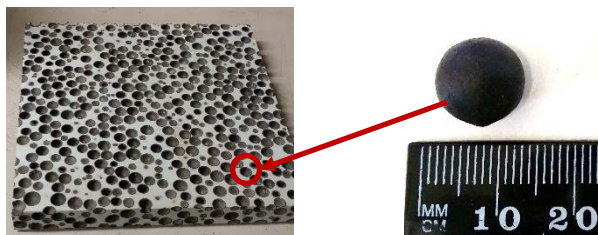
Glass spheres (D50  $\mu\text{m}$ )

Carbon fiber reinforced macro-spheres (D10 mm)

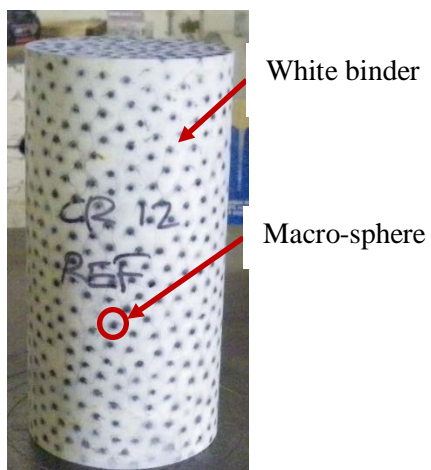

White syntactic foam

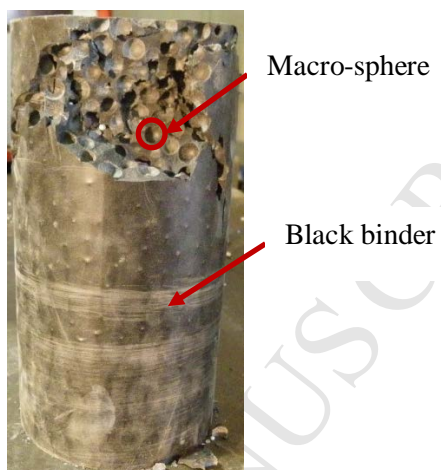

Black syntactic foam

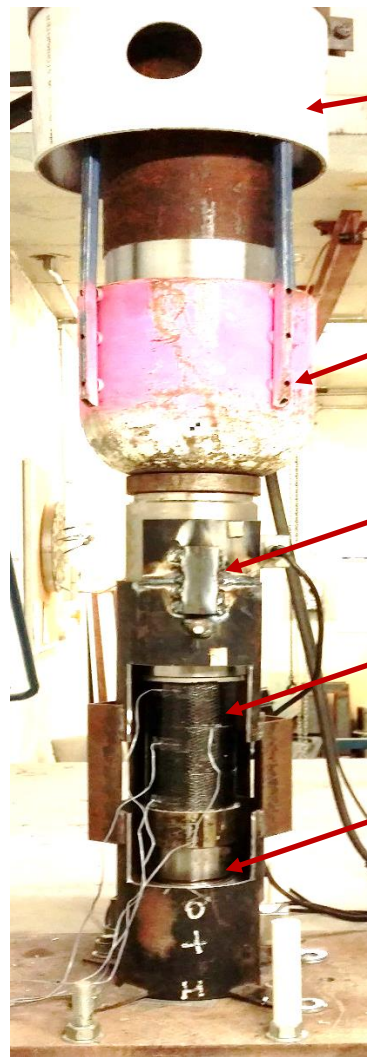

Plastic  
guiding tube

Steel projectile

Protective tube

Specimen

Load cell

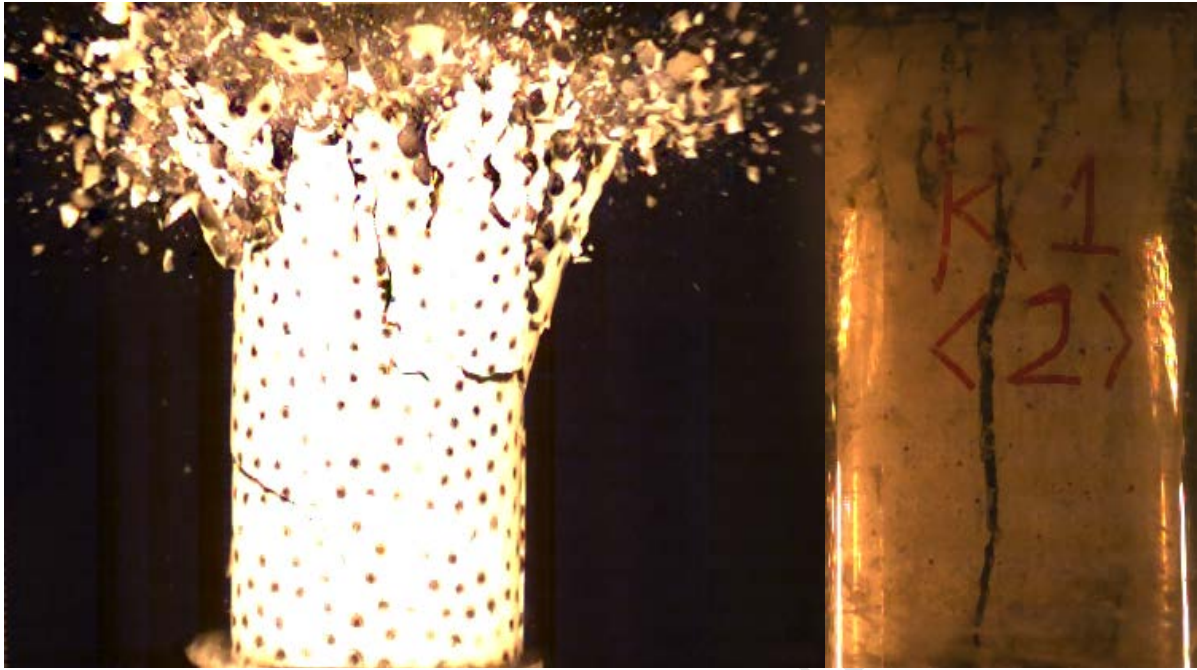

Crushing failure of syntactic foam

Splitting failure of concrete

ACCEPTED MANUSCRIPT

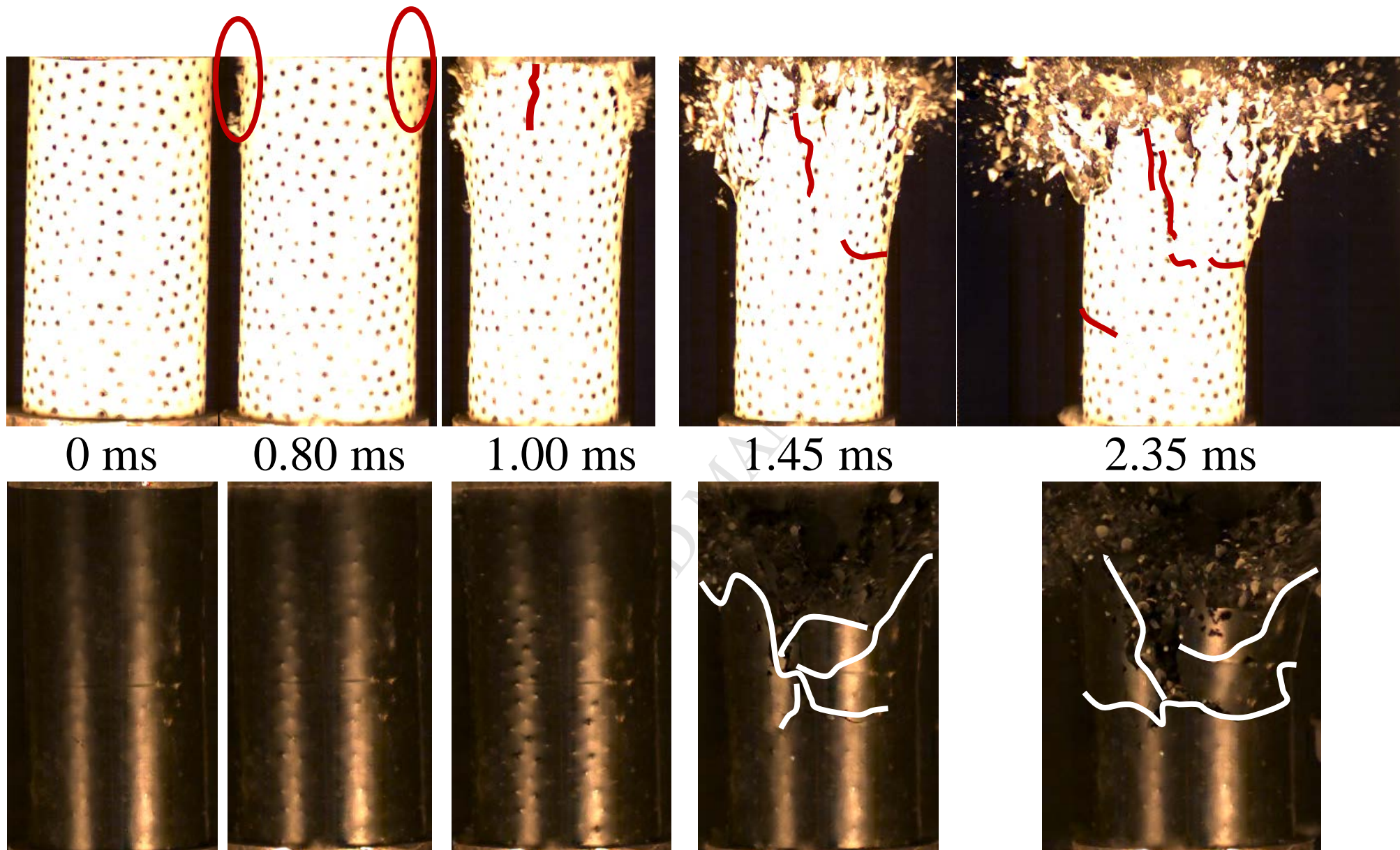

0 ms

0.80 ms

1.00 ms

1.45 ms

2.35 ms

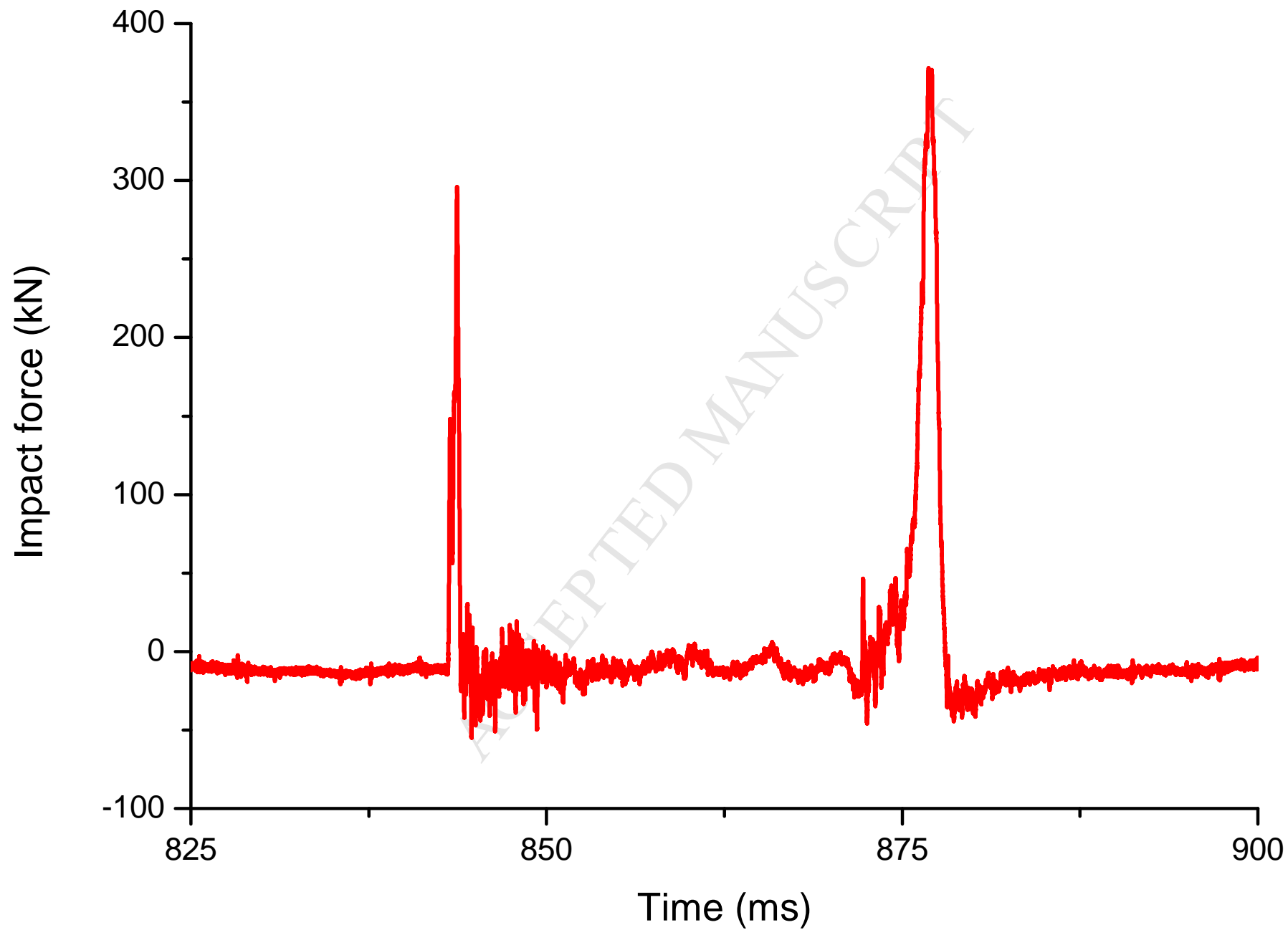

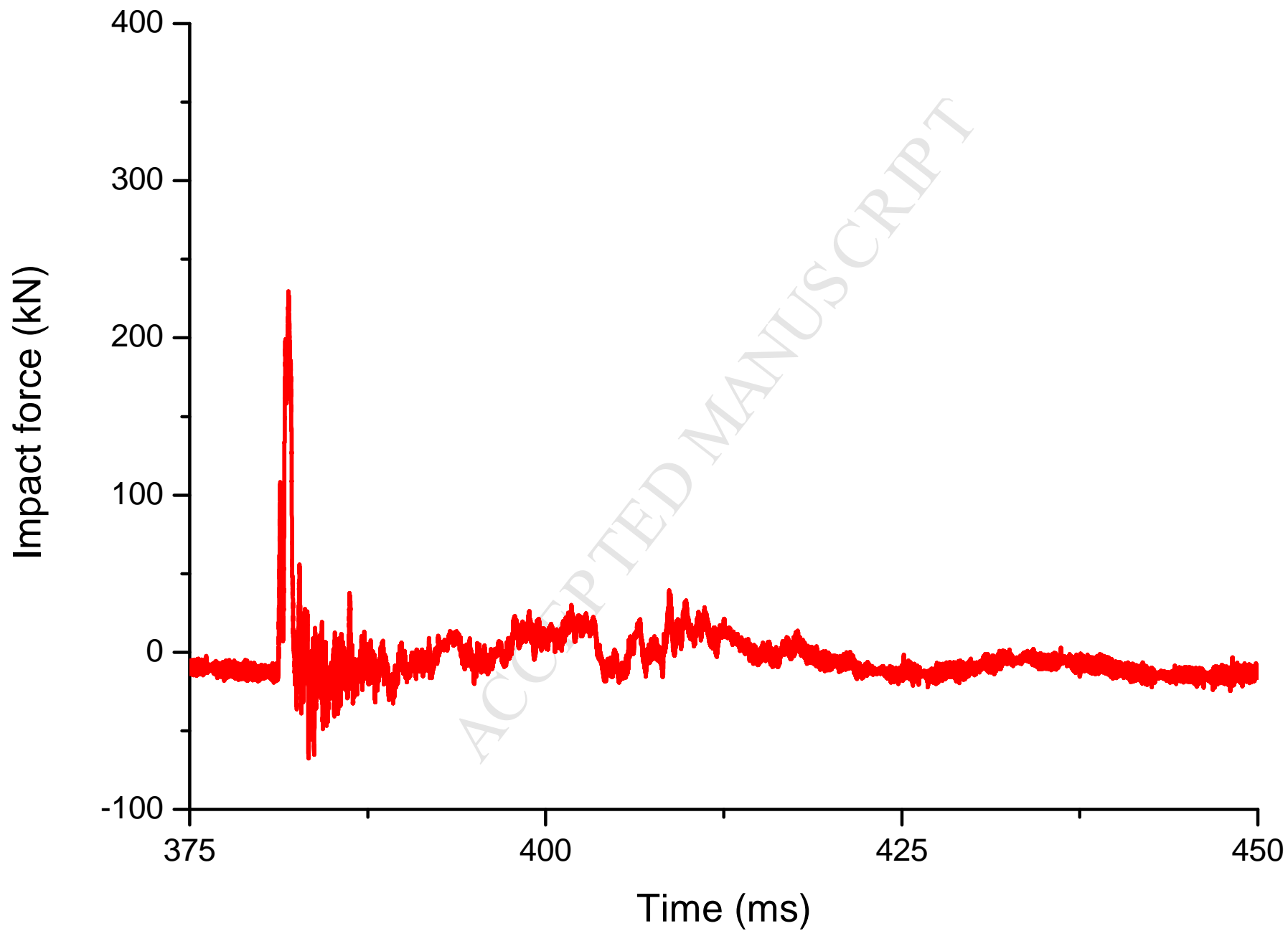



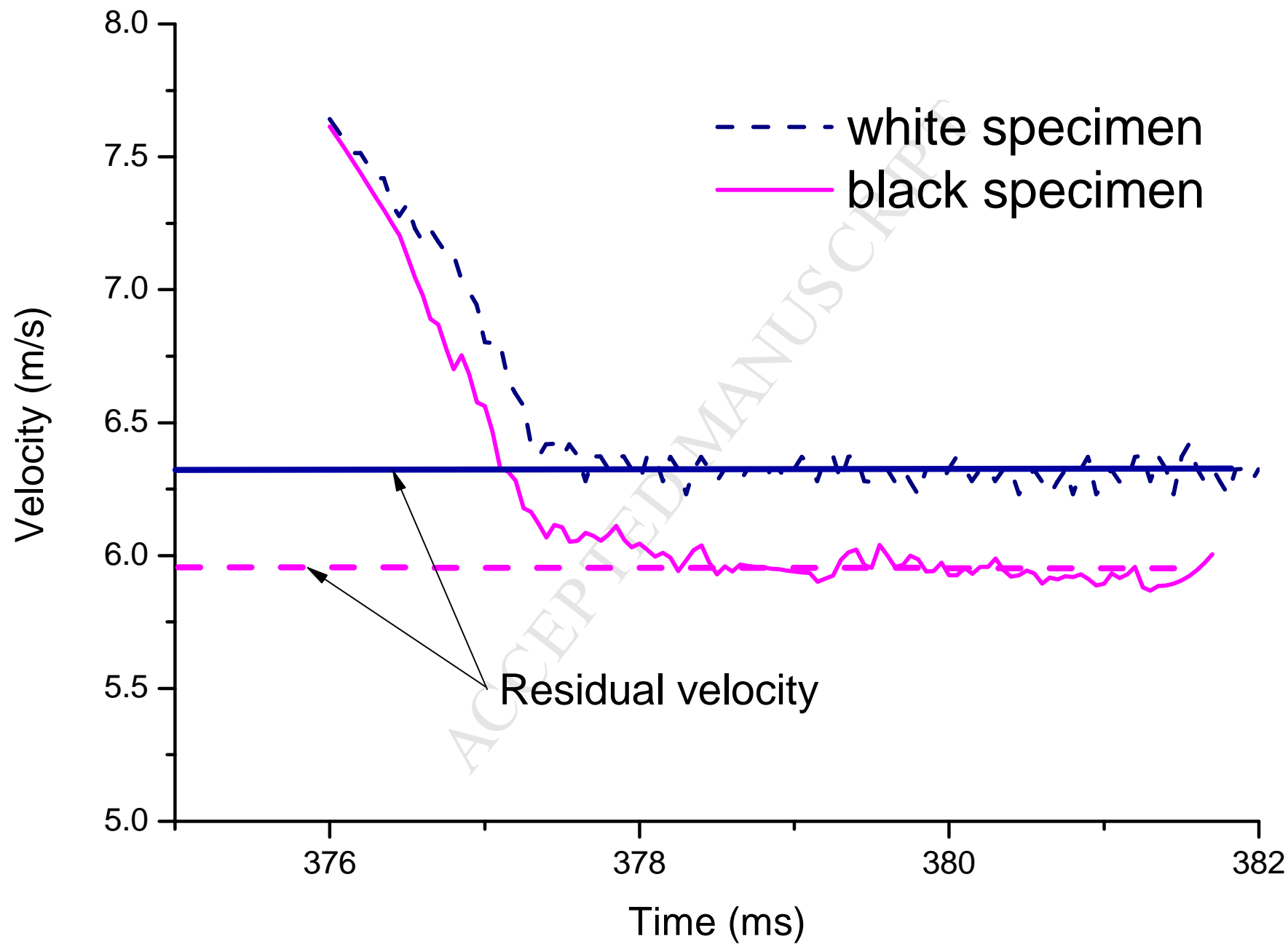

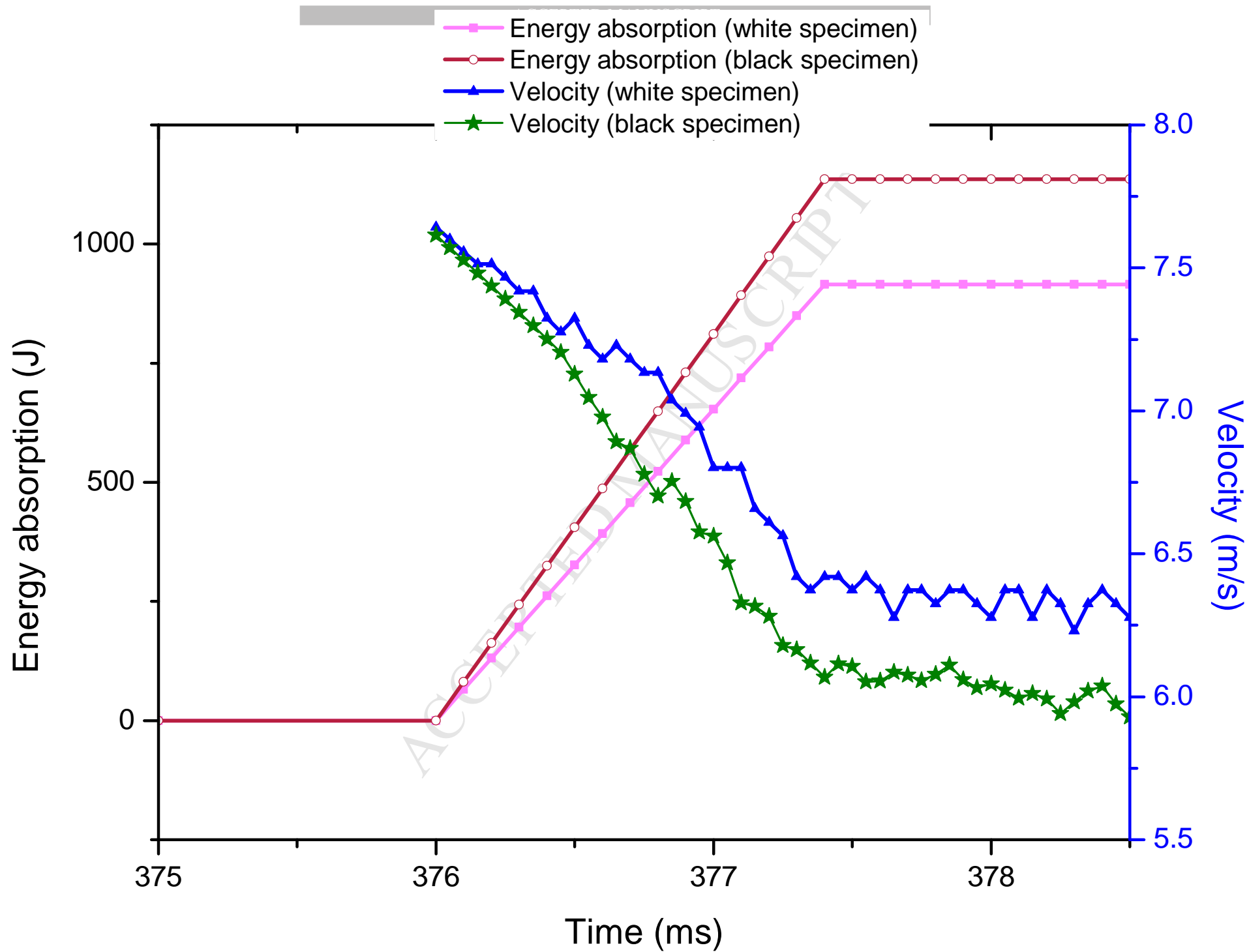

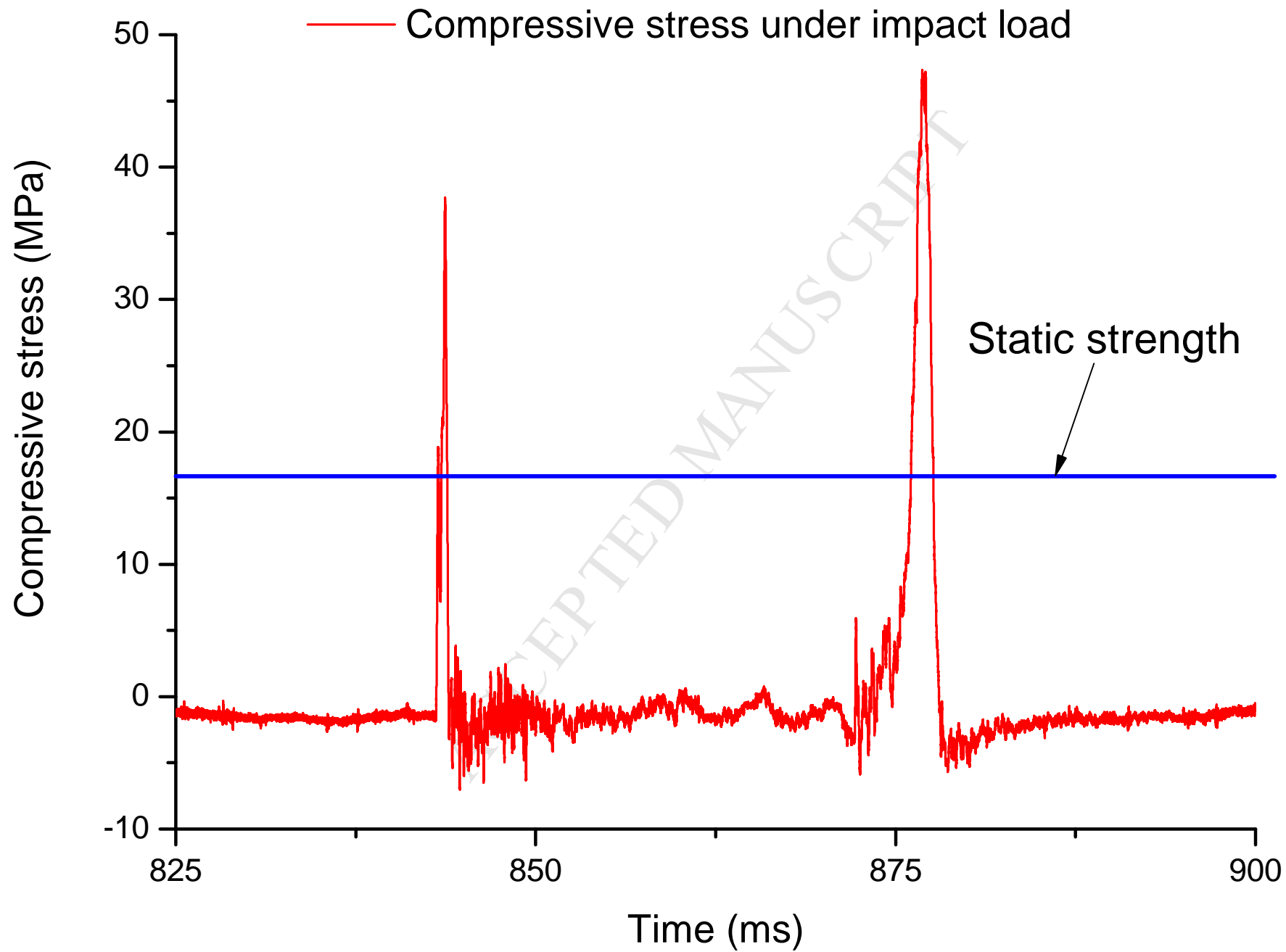

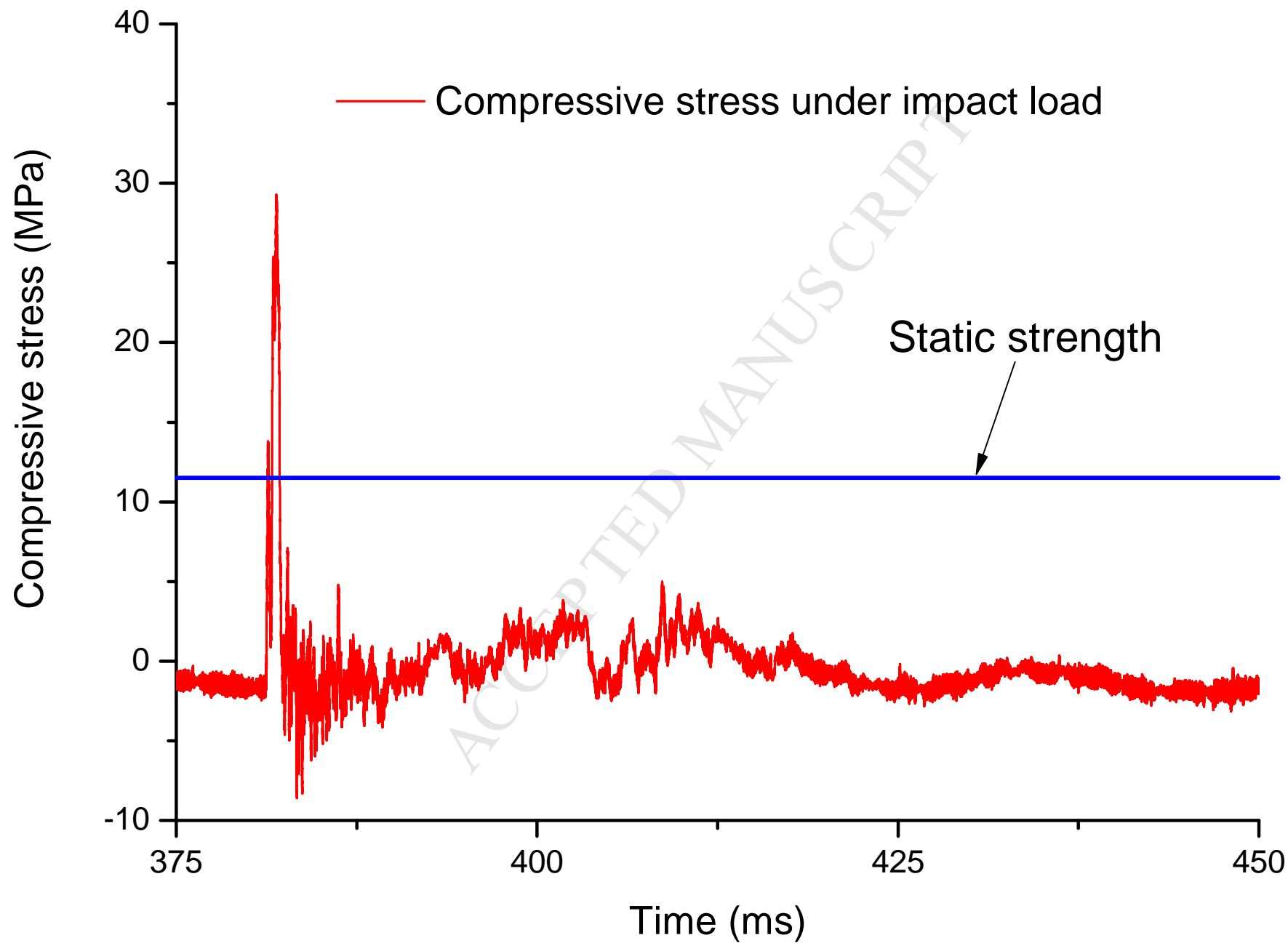

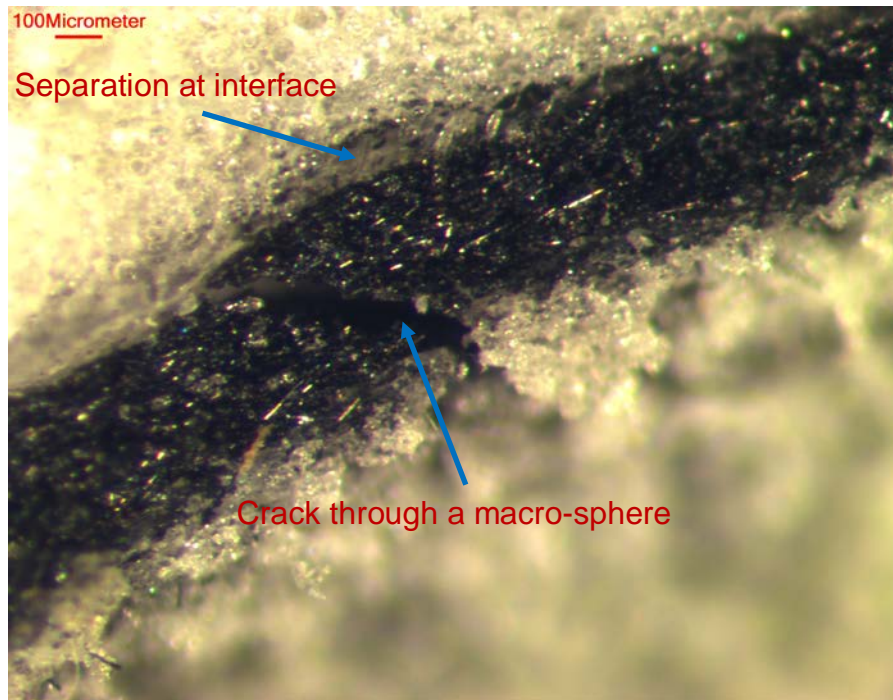

ACCEPTED

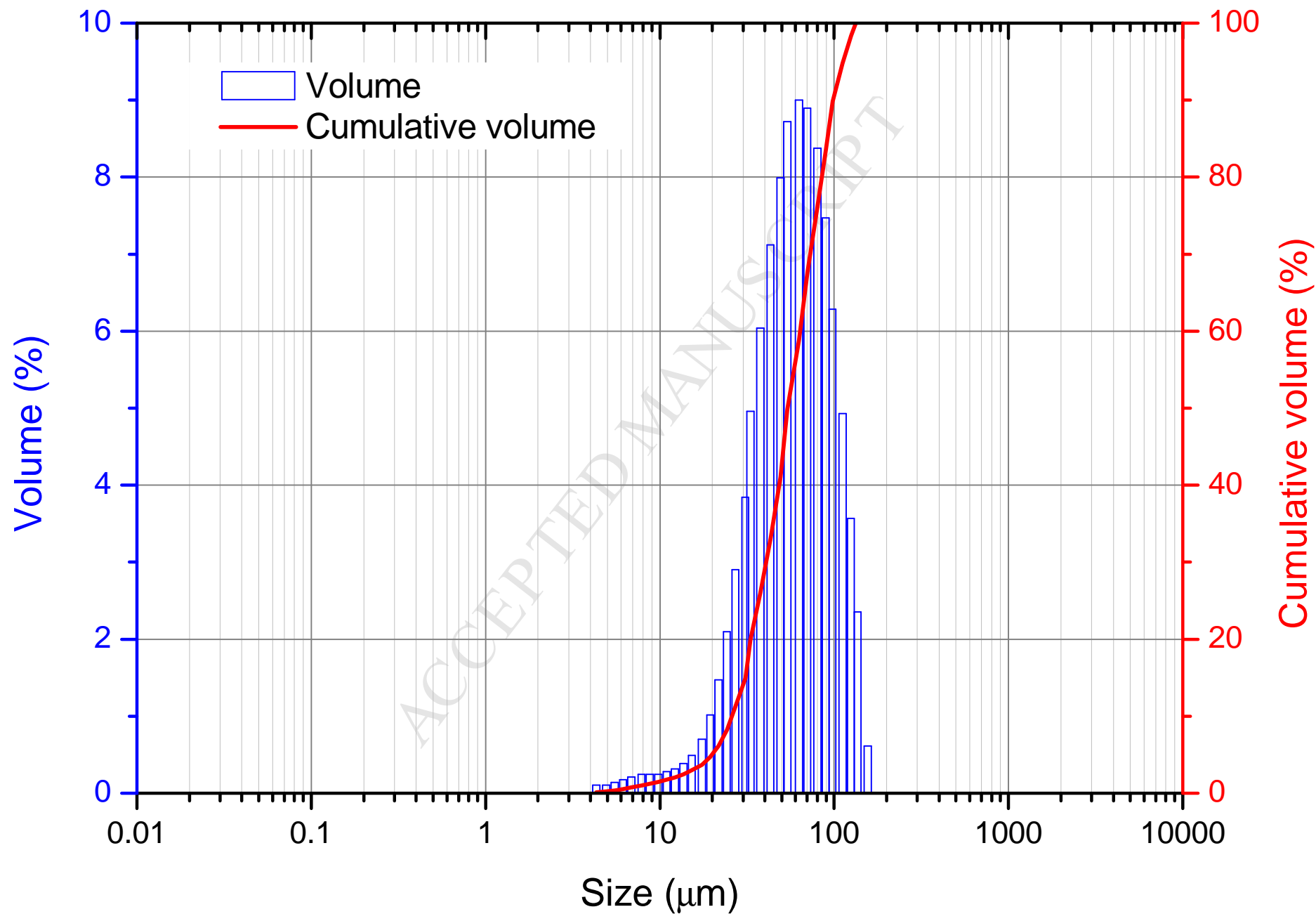

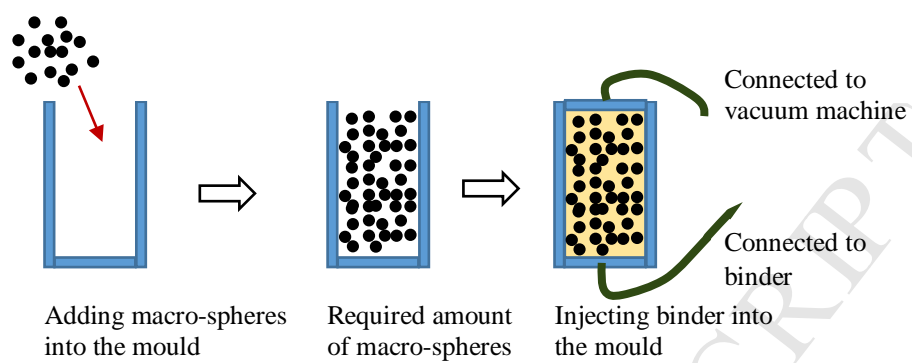

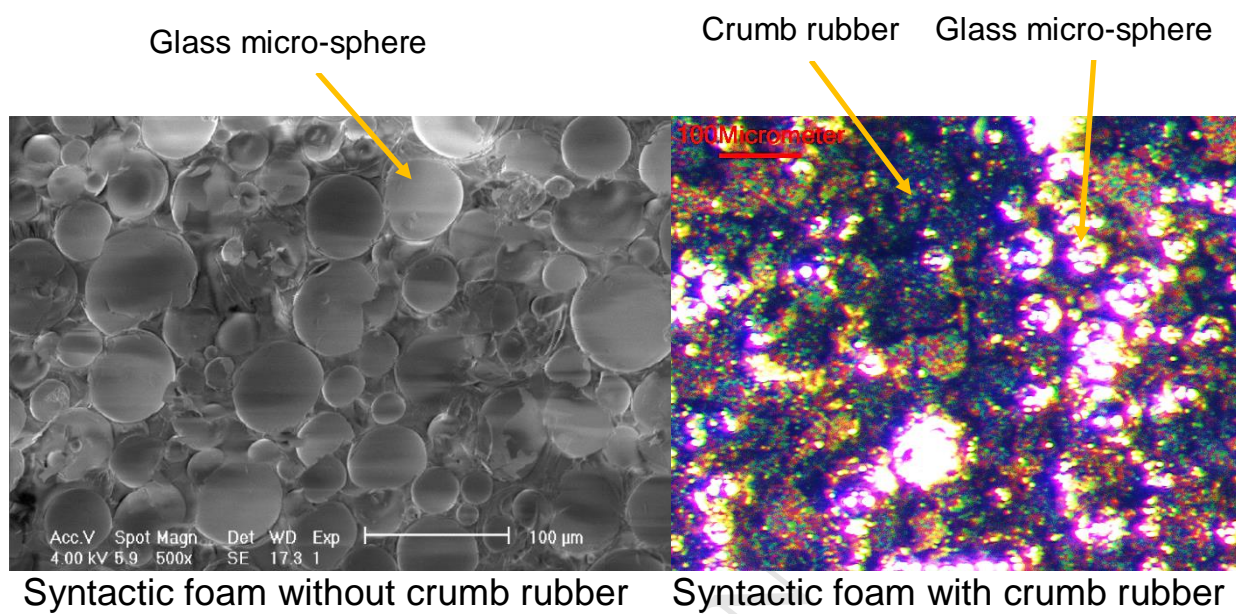



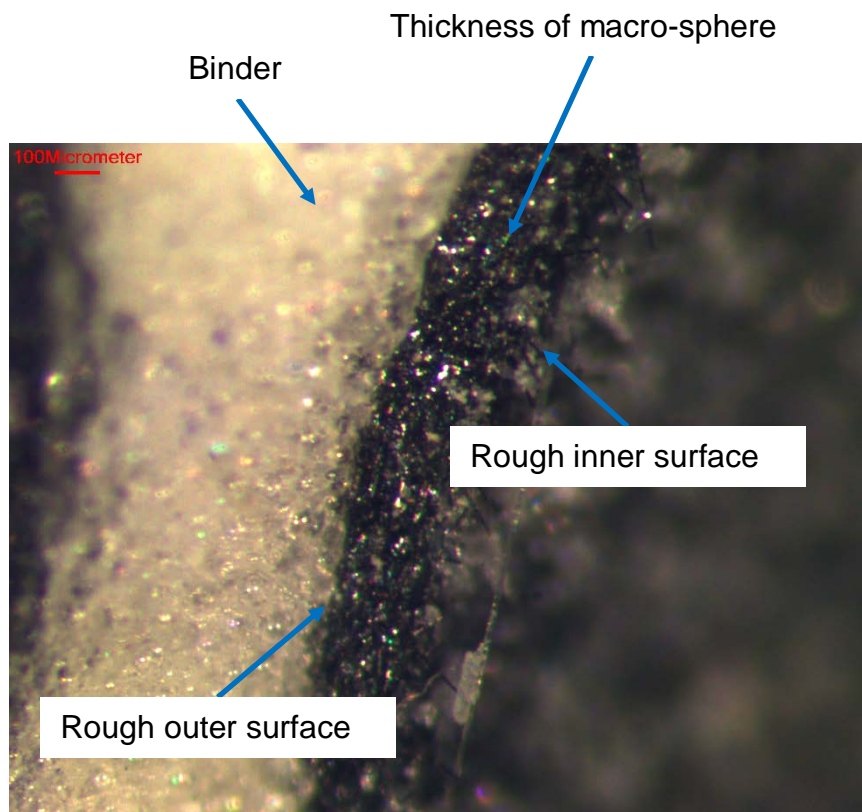

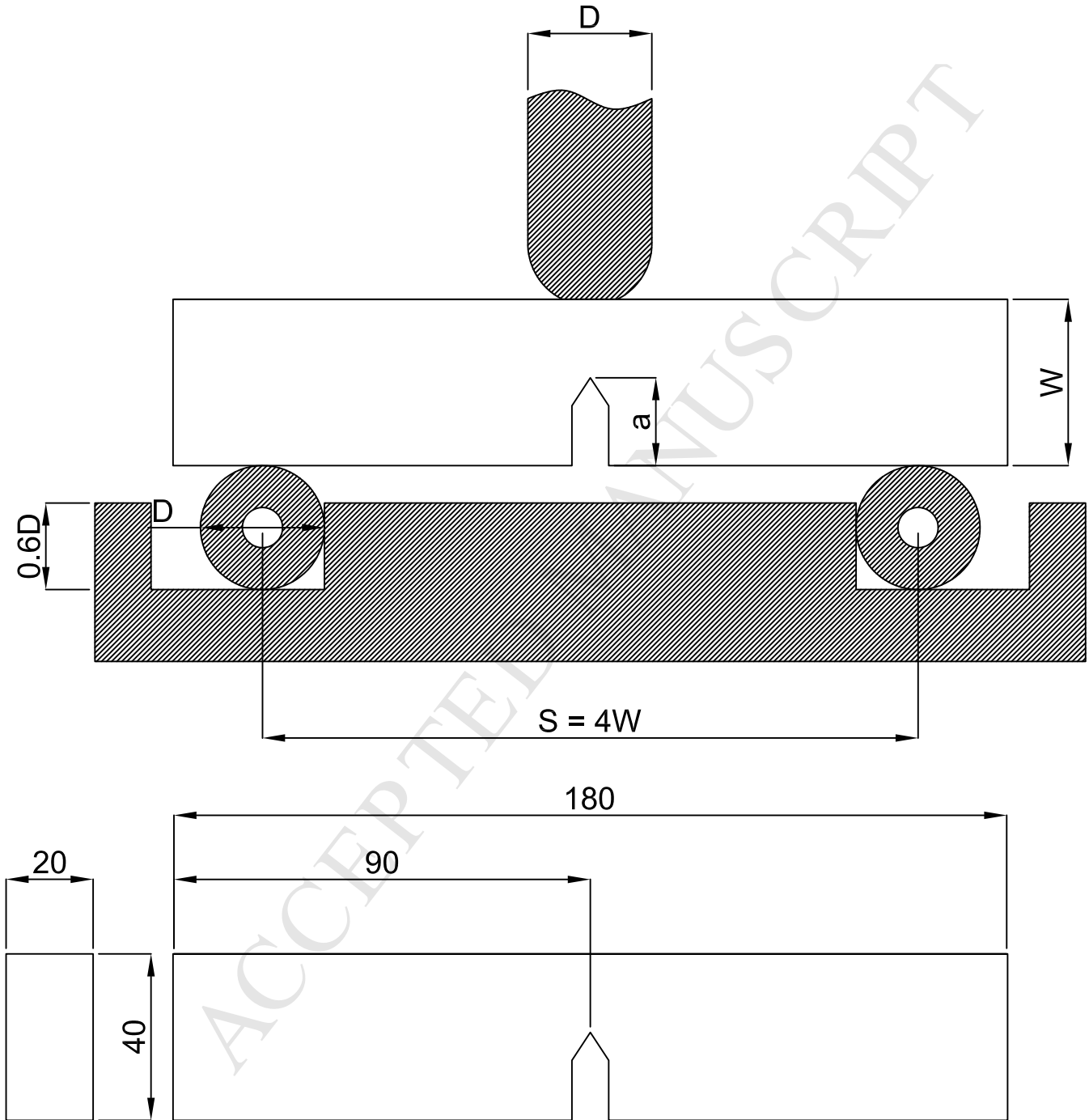



White syntactic foam



Black syntactic foam

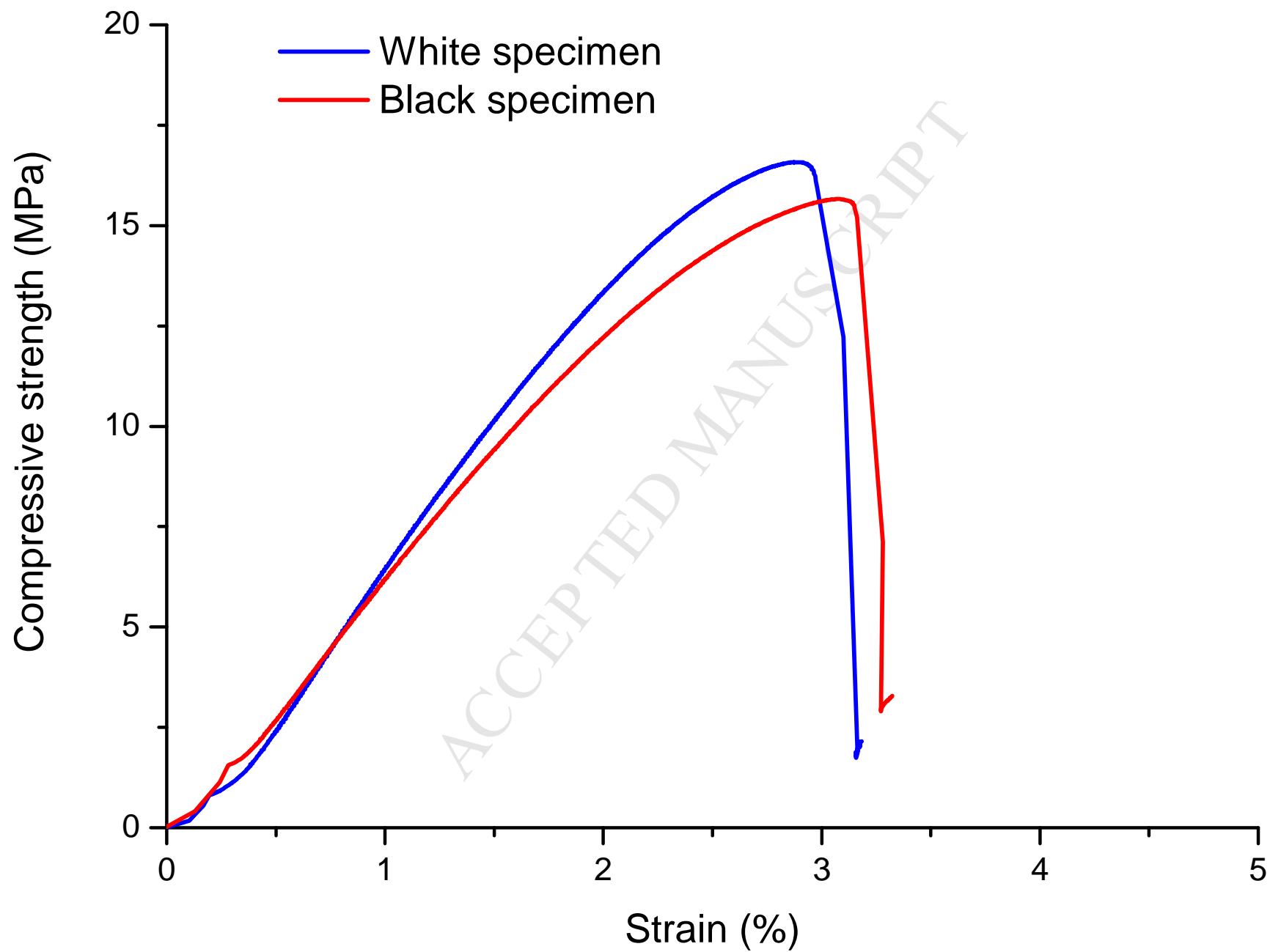

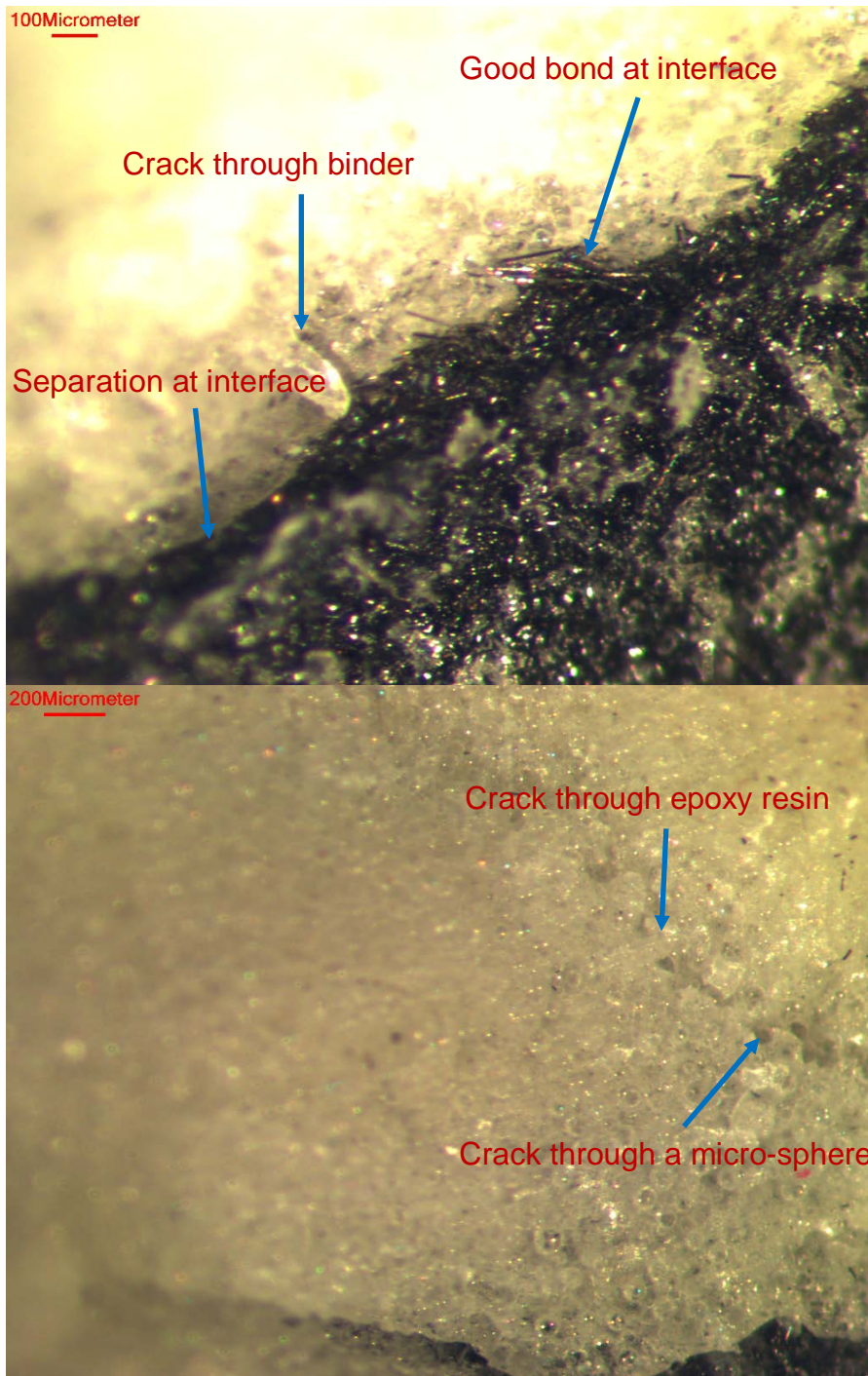

## HIGHLIGHTS

- Fracture toughness of multiphase syntactic foam
- Impact behavior of multiphase syntactic foam
- Effect of rubber content on mechanical properties
- Impact testing of syntactic foam
- Dynamic properties
- Coating with epoxy resin