

Faculty of Science & Engineering

Western Australian School of Mines: Minerals, Energy and Chemical

Engineering

**Reducing Minimum Miscibility Pressure in Gas Injection
for Enhanced Oil Recovery**

Mohamed Khaled Elsheikh Almobarak

0000-0003-2346-4302

This thesis is presented for the Degree of

Doctor of Philosophy

Curtin University

March 2023

Declaration of Academic Integrity

To the best of my knowledge and belief, this thesis contains no material previously published by any other person except where due acknowledgment has been made.

This thesis contains no material which has been accepted for the award of any other degree or diploma in any university.

Signature:

Date: 31st of March 2023

Copyright

I warrant that I have obtained, where necessary, permission from the copyright owners to use any third-party copyright material reproduced in the thesis (e.g., questionnaires, artwork, unpublished letters), or to use any of my own published work (e.g., journal articles) in which the copyright is held by another party (e.g., publisher, co-author).

Signature:

Date: 31st of March 2023

Acknowledgments

I would like to express my sincere gratitude to my respected main **supervisor**

Dr. Quan Xie and co-supervisors **Associate Professor Ali Saeedi, Dr. Colin Wood, and**

Dr. Matthew Myers for their continuous support of my Ph.D. study and related research, for their patience, motivation, and immense knowledge.

The knowledge, insights, and thoughtful suggestions they brought to me truly contributed to the completion of this research. It is a great honour and privilege for me to do my Ph.D. under their supervision which has opened up a new horizon of opportunities in front of me to enhance the quality and applicability of my research.

During this work, I have companied with many wonderful colleagues in Petroleum Engineering Discipline at Curtin University for whom I have great regard, and I wish to extend my warmest thanks to all those who have offered help, friendship, and technical support during my work in this project.

I acknowledge that Curtin University works across hundreds of traditional lands and custodial groups in Australia, and with First Nations people around the globe. I also wish to pay deepest respects to their ancestors and members of their communities, past, present, and to their emerging leaders. Our passion and commitment to work with all Australians and peoples from across the world, including our First Nations peoples are at the core of the work we do, reflective of our institutions' values and commitment to our role as leaders in the Reconciliation space in Australia.

Executive Summary

Hydrocarbon resources represent a significant part of the energy landscape and will likely remain important to meet the increasing global energy demand. Typically, primary and secondary oil recovery methods produce only one-third of the original oil in place. Therefore, enhanced oil recovery (EOR) techniques are essential to unlock the significant amount of residual oil in the reservoir. In this context, gas injection is widely considered as one of the most practical and efficient enhanced oil recovery methods, in particular for light and medium crude oil, due to its lower cost and higher recovery factor compared to other enhanced oil recovery techniques. Furthermore, capturing and utilizing carbon dioxide or methane in the gas injection process contribute to reducing greenhouse emissions and consequently achieving the global target of net-zero emissions as part of the injected gas is permanently stored in the reservoir. However, the success of the gas injection process depends mainly on the minimum miscibility pressure (MMP) between the injected gas and the crude oil.

Generally, gas injection process is more beneficial when the injection is performed under miscible conditions as it results in up to 15% higher oil recovery compared to immiscible injection. However, the main challenge of the miscible gas injection is the high minimum miscibility pressure between gas and oil, especially for methane/natural gas compared to carbon dioxide gas, which results in limited application of miscible hydrocarbon gas injection.

The aim of this research is to investigate the potential of reducing the minimum miscibility pressure in methane-oil systems using chemical additives, which could provide a novel solution to expand the application envelop of methane/hydrocarbon gas injection for EOR. Furthermore, re-injection/recycling of the produced natural gas instead of venting or flaring

will assist in the much-needed global environmental target of achieving the Net Zero emissions in addition to the economic benefits of increasing the ultimate oil recovery factor. This research is mainly focused on the methane gas due to its significant impact on the environment and its much higher (up to 25 times) global warming potential (GWP) compared to CO₂.

To achieve the research objectives, firstly, a detailed literature review was performed to highlight the gap in the literature about reducing the minimum miscibility pressure of methane and natural gas systems compared to similar studies for CO₂-oil systems. Secondly, experimental investigation was implemented to measure the interfacial tension (IFT) between methane gas and the tested crude oil before and after adding different chemical additives to estimate the potential MMP reduction. Afterwards, coreflooding experiments were performed to quantify the effect of chemical-assisted MMP reduction on the oil recovery factor at core scale. Finally, a large database was collected from the literature to utilize data analysis techniques to identify the controlling factors of the miscibility process in the methane-oil system under a wide range of pressure, temperature and gas and oil compositions. Consequently, machine learning models were built to accurately predict MMP values in methane-oil and hydrocarbon gas-oil systems.

The interfacial tension experiments presented promising results of using chemical additives to improve methane-oil miscibility, as the MMP of the system could be reduced by 9% through adding 1.5 wt.% of surfactant-based chemical, while the coreflooding experiments demonstrated the significant impact of the MMP reduction on the oil recovery factor, as the recovery factor increased by 11.7% (from 65.5% to 77.2%) when the injection is performed under miscibility condition in the presence of the chemical additive.

The exploratory data analysis of the collected MMP database highlighted that the controlling factors of the miscibility is highly dependent on the gas composition. Therefore, in the light of this analysis, two separate machine learning models were presented in this research to accurately predict the MMP in pure methane-oil system and hydrocarbon gas-oil system using multilayer perceptron (MLP) neural network algorithm and support vector regression (SVR) algorithm. The presented machine learning models predict the MMP within an error of 5%.

The results of this research highlight, for the first time, the potential of chemical assisted MMP reduction as a novel solution to increase the ultimate oil recovery factor during methane gas injection for enhanced oil recovery, beside contributing to achieving the global target of reducing the greenhouse gas emissions by enabling miscible gas injection in more candidate reservoirs.

List of Publications

Published Papers forming part of the thesis:

1. *Almobarak, M., et al., A review of chemical-assisted minimum miscibility pressure reduction in CO₂ injection for enhanced oil recovery. Petroleum, 2021.*

[DOI: 10.1016/j.petlm.2021.01.001](https://doi.org/10.1016/j.petlm.2021.01.001)

2. *Almobarak, M., et al., Chemical-assisted minimum miscibility pressure reduction between oil and methane. Journal of Petroleum Science and Engineering, 2021. 196.*

[DOI: 10.1016/j.petrol.2020.108094](https://doi.org/10.1016/j.petrol.2020.108094)

3. *Almobarak, M., et al., Effect of Functional Groups on Chemical-Assisted MMP Reduction of a Methane-Oil System. Energy & Fuels, 2021. 35(18): p. 14519-14526.*

<https://doi.org/10.1021/acs.energyfuels.1c01479>

4. *Almobarak, M., et al., Chemical-Assisted MMP Reduction on Methane-Oil Systems: Implications for Natural Gas Injection to Enhanced Oil Recovery. Petroleum, 2022.*

<https://doi.org/10.1016/j.petlm.2022.07.001>

Table of Contents

Declaration of Academic Integrity.....	2
Executive Summary.....	5
List of Publications.....	8
Table of Contents.....	9
List of Figures.....	12
Chapter 1 Introduction.....	15
1.1 Background.....	15
1.2 Research Objectives.....	16
1.3 Thesis Organization and Outlines.....	17
Chapter 2 Literature Review of Chemical-Assisted MMP Reduction.....	21
2.1 Enhanced Oil Recovery (EOR).....	21
2.2 Miscibility.....	22
2.2.1 Minimum Miscibility Pressure (MMP).....	24
2.3 MMP Measurement Methods.....	24
2.3.1 Slim Tube Test.....	24
2.3.2 Vanishing Interfacial Tension.....	26
2.3.3 Rising Bubble Apparatus.....	28
2.4 Trials of Reducing MMP in CO ₂	30
2.4.1 Chemical-Assisted MMP Reduction.....	30
2.4.2 Gas Impurities Effect.....	36
2.5. Summary of Existing Results.....	39
2.6. Knowledge Gaps.....	41
2.7. Conclusion.....	41
Chapter 3 Research Framework and Methodology.....	43
3.1. Research Overview.....	43
3.2. Research Methodology.....	44
3.2.1. Interfacial Tension Measurements.....	44
3.2.2. Coreflooding Experiments.....	45
3.2.3. Predict MMP in Hydrocarbon Gas-Oil System.....	46
Chapter 4 Chemical-Assisted Minimum Miscibility Pressure Reduction between Oil and Methane.....	48
Abstract.....	48
4.1. Introduction.....	49
4.2. Experimental Methodology.....	52

4.2.1 Materials	52
4.2.2 Experimental Setup and Procedures.....	55
4.3. Results and Discussion	58
4.3.1 Effect of Pressure and Temperature on the IFT of Methane-Oil System Without Chemicals	58
4.3.2 Effect of Different Chemical Additives on the IFT Reduction.....	61
4.3.3 Effect of Temperature on Chemical Performance in Reducing MMP.....	64
4.4. Proposed Mechanism from Surface Chemistry Perspective	65
4.5. Conclusions and Implications	68
Chapter 5 Effect of Functional Groups on Chemical-Assisted MMP Reduction of a Methane-Oil System.....	69
Abstract.....	69
5.1. Introduction.....	70
5.2. Experimental and Procedures.....	73
5.2.1. Material	73
5.2.2. Procedures of Interfacial Tension Measurements	74
5.3. Results and Discussion	75
5.3.1. Effect of Pressure on Miscibility of Methane-Oil System	75
5.3.2. Effect of Functional Head Groups on MMP	77
5.3.3. Effect of Hydrocarbon Chain Length.....	81
5.3.4. Proposed Mechanisms.....	84
5.4. Conclusion and Implications.....	86
Chapter 6 Chemical-Assisted MMP Reduction on Methane-Oil Systems: Implications for Natural Gas Injection to Enhanced Oil Recovery.....	87
Abstract.....	87
6.1. Introduction.....	88
6.2. Methodology	91
6.2.1. Material	91
6.2.2. Experimental Procedures	92
6.3. Results and Discussion	96
6.3.1. Methane-Oil MMP Reduction	96
6.3.2. Effect of chemical-assisted gas injection	99
6.3.3. Effect of Gas Mixture on the Recovery Factor at Secondary Mode	103
6.4. Conclusion and Implications.....	105
Chapter 7 Data Analysis of MMP in Hydrocarbon Gas-Oil System.....	107
7.1 Problem Statement.....	107
7.2 Literature Review.....	107

7.3 Data Collection	111
7.4. Exploratory Data Analysis and Visualization	117
7.4.1. Data Exploration	117
7.4.2. Data Visualization.....	124
7.5. Conclusion	130
Chapter 8 Machine Learning to Predict MMP in Hydrocarbon Gas-Oil Systems ..	132
8.1. Introduction.....	132
8.2. Literature Review.....	133
8.3. Methodology	136
8.3.1. Model Selection	136
8.3.2. Model Evaluation.....	139
8.4. Results and Discussion	140
8.4.1. MMP Model Results for Hydrocarbon Gas-Oil System	140
8.4.2. MMP Model Results for Methane-Oil System	146
8.4.3. Model Performance Comparison	152
8.5. Conclusion	153
Chapter 9 Conclusion and Recommendations	155
9.1. Conclusion	155
9.2. Recommendations.....	159
References.....	161
Appendices.....	Error! Bookmark not defined.
Appendix 1.....	Error! Bookmark not defined.
Appendix 2.....	Error! Bookmark not defined.
Appendix 3.....	Error! Bookmark not defined.
Appendix 4.....	Error! Bookmark not defined.

List of Figures

Figure 1.1 Global energy consumption by source [1].....	16
Figure 2.1 Number of EOR projects worldwide [12]	22
Figure 2.2 Miscibility schematic diagram [33].....	23
Figure 2.3 Schematic diagram of slim tube equipment.....	25
Figure 2.4 Schematic diagram of IFT equipment	27
Figure 2.5 Schematic diagram of rising bubble apparatus (RBA).....	29
Figure 3.1 Research methodology and framework	44
Figure 3.2 Example of IFT measurement	45
Figure 4.1 Schematic diagram for interfacial tension (IFT) measurements.....	56
Figure 4.2 IFT in CH ₄ -oil system at 333 & 373 K.....	60
Figure 4.3 Schematic diagram of methane-chemical-oil interaction	66
Figure 4.4 Sketch of the tested functional groups. a) alcohol based chemical with hydroxyl group, b) surfactant based chemical with ethoxylated and propoxylated groups, and c) surfactant based chemical with propoxylated group.....	67
Figure 5.1 Structure of the six chemical additives used in this study	74
Figure 5.2 Schematic diagram for interfacial tension (IFT) measurements at HT-HP	75
Figure 5.3 IFT of pure CH ₄ -crude oil system at 373 K with no additives	76
Figure 5.4 IFT of CH ₄ -oil at 373 K for 2 wt.% additive (a) (containing 2-oxopyrrolidine group).....	78
Figure 5.5 IFT of CH ₄ -oil at 373 K for 2 wt.% additive (b) (containing aromatic sulfonic acid group)	79
Figure 5.6 IFT of CH ₄ -oil at 373 K for 2 wt.% additive (f) (containing aromatic carboxylic acid group).....	80
Figure 5.7 IFT of CH ₄ -oil at 373 K for 2 wt.% additive (c) (containing morpholine group)	81
Figure 5.8 IFT of CH ₄ -oil at 373 K for 2 wt.% additive (d) (containing 2-oxopyrrolidine group, longer hydrocarbon chain)	83
Figure 5.9 IFT of CH ₄ -oil at 373 K for 2 wt.% additive (e) (containing aromatic sulfonic acid group, longer hydrocarbon chain)	83
Figure 6.1 Schematic diagram of the interfacial tension equipment [128].	93
Figure 6.2 Schematic diagram for coreflooding setup.	96
Figure 6.3 IFT of CH ₄ -oil at 373 K as a function of pressure without chemical additives [132].	97
Figure 6.4 IFT of gas-oil system with chemical and gas mixture (CH ₄ 80 mol % and CO ₂ 20 mol %) without chemical compared to pure methane-oil system at 373 K.	98
Figure 6.5 1 st experiment: Secondary recovery factor using CH ₄ at immiscible conditions, and tertiary recovery using chemical-assisted CH ₄ (core 1).	100
Figure 6.6 2 nd experiment: Secondary recovery using chemical-assisted CH ₄ at 373K (Core 2) compared to the 1 st experiment (Core 1).	101

Figure 6.7 Recovery factor of gas mixture compared to chemical-assisted methane at 373 K (cores 2 & 3).....	104
Figure 7.1 Flowchart of the data science process [161].....	117
Figure 7.2 Histogram of the MMP data	119
Figure 7.3 Histogram of the methane content in the gas.....	120
Figure 7.4 Pearson correlation heatmap for the collected MMP database (153 data points).....	122
Figure 7.5 Pearson correlation heatmap for gas composition with methane content over 80% (61 data points)	123
Figure 7.6 MMP vs Temperature relationship in hydrocarbon gas-oil system.....	125
Figure 7.7 MMP vs Temperature relationship with methane content over 80%	125
Figure 7.8 MMP vs methane content in hydrocarbon gas-oil system.....	126
Figure 7.9 MMP vs methane content with temperature variation in hydrocarbon gas-oil system.....	127
Figure 7.10 MMP vs critical gas temperature in hydrocarbon gas-oil system.....	128
Figure 7.11 MMP vs oil composition in hydrocarbon gas-oil system	129
Figure 7.12 MMP vs oil composition with methane content over 80% (61 points)	130
Figure 8.1 Schematic diagram of ANN [171].....	138
Figure 8.2 Schematic diagram of SVR [175].....	139
Figure 8.3 MLP model performance in the training stage for MMP prediction in hydrocarbon-gas oil system	141
Figure 8.4 MLP model performance in the validation stage for MMP prediction in hydrocarbon-gas oil system	142
Figure 8.5 Overall MLP model performance for MMP prediction in hydrocarbon-gas oil system....	143
Figure 8.6 SVR model performance in the training stage for MMP prediction in hydrocarbon-gas oil system	144
Figure 8.7 SVR model performance in the validation stage for MMP prediction in hydrocarbon-gas oil system	145
Figure 8.8 Overall SVR model performance for MMP prediction in hydrocarbon-gas oil system....	146
Figure 8.9 MLP model performance in the training stage for MMP prediction in methane-gas oil system	147
Figure 8.10 MLP model performance in the validation stage for MMP prediction in methane-gas oil system	148
Figure 8.11 Overall MLP model performance for MMP prediction in methane-gas oil system	149
Figure 8.12 SVR model performance in the training stage for MMP prediction in methane-gas oil system	150
Figure 8.13 SVR model performance in the validation stage for MMP prediction in methane-gas oil system	151
Figure 8.14 Overall SVR model performance for MMP prediction in methane-gas oil system.....	152

List of Tables

Table 2.1 Summary of MMP reduction using different chemicals	36
Table 2.2 List of tested gas impurities [91]	37
Table 2.3 Summary of main MMP reduction experiments.....	40
Table 2.4 Summary of main IFT reduction experiments	40
Table 4.1 Compositional Analysis results of crude oil in mole percentage.....	53
Table 4.2 Properties of the chemical additives used in IFT experiments	55
Table 4.3 Summary of IFT experimental results in methane-oil system at 373 K	64
Table 4.4 Summary of IFT experimental results in methane-oil system at 333 K	65
Table 5.1 Summary of IFT experimental results in methane-oil system at 373 K	84
Table 6.1 Rock properties of the tested core samples (gas mix is 80/20 mole:mole CH ₄ /CO ₂) *	95
Table 6.2 Summary of coreflooding results*	104
Table 7.1 summary of number of MMP points for each of the main data sources.	112
Table 7.2 Hydrocarbon gas-oil MMP database.	113
Table 7.3 statistical summary of the collected MMP database.....	118
Table 8.1 summary of MMP prediction for hydrocarbon gas-oil system.	135
Table 8.2 Model performance comparison summary	153

Chapter 1 Introduction

Reducing greenhouse gas emissions is the key factor for achieving the global target of net-zero emissions by 2050, which is essential to stop the global warming. The urgency and severity of the problem requires applying new technologies and using different utilization and storage ideas to accelerate achieving the net-zero emissions target. In this context, despite its low percentage (~17%) in the greenhouse gases (GHG), methane gas has much higher (up to 25 times) global warming potential (GWP) compared to carbon dioxide. Therefore, capturing and utilizing methane emissions represent a crucial step towards achieving the net-zero emissions target. In this research, the main target is to investigate the potential of reducing the minimum miscibility pressure (MMP) in the methane-oil systems which will likely expand the application envelop of miscible methane/natural gas injection, and consequently provide a novel solution to utilize the produced methane/natural gas instead of venting or flaring.

This chapter introduces the importance of enhanced oil recovery (EOR) and presents the main challenges associated with miscible natural gas injection, then the main research objectives and the methodology to achieve these objectives. Finally, a brief description about the thesis structure and the contents of each chapter are outlined in section three.

1.1 Background

To date, the world energy sector still depends on fossil fuels to supply around 84% of the energy demand [1]. In particular, crude oil represents about 33% of the global energy consumption, as reported by BP statistical review of world energy 2020 [1] (Figure 1.1 below). Typically, production of crude oil is performed through three recovery stages. The primary and secondary recovery stages result in producing around one third of the original oil in place (OOIP). Afterwards, enhanced oil recovery (EOR) techniques play a major role to

unlock the significant amount of the residual crude oil in the reservoir. In this context, gas injection is the most widely applied EOR method for light and medium crude oil recovery.

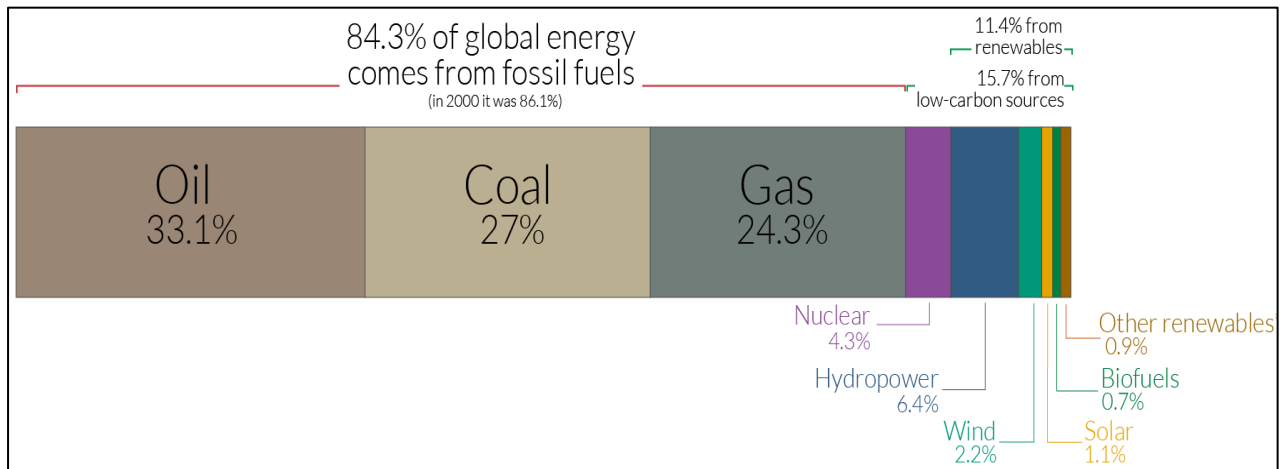

Figure 1.1 Global energy consumption by source [1]

Gas injection EOR results in up to 15% higher oil recovery when performed under miscible condition. However, achieving miscibility can be technically challenging due to the high minimum miscibility pressure between gas and oil phases which could exceed the formation fracture pressure in case of shallow reservoirs or could be extremely high in case of high temperature reservoirs. The problem of high MMP is even more challenging using methane as an injection gas due to its much higher MMP (up to three times) compared to CO₂. Therefore, to further achieve reservoirs' potential, there is a pressing need to explore a viable means to decrease the miscibility pressure in the gas-oil system, and thus expand the application envelop of miscible gas injection to more candidate reservoirs.

1.2 Research Objectives

The aim of this research is present a novel study to investigate, for the first time, the potential of reducing the minimum miscibility pressure of methane-oil systems, which may consequently enable efficient utilization of the produced gas instead of venting or flaring,

resulting in the much-needed environmental benefits of reducing the greenhouse gas emissions, in addition to the economic benefits of increasing oil recovery.

The followings outline the specific objectives pursued in conducting the different phases of this research:

- Literature review of the existing work to highlight the importance of reducing MMP in gas injection, and to identify the knowledge gaps regarding MMP reduction in methane-oil systems.
- Experimental investigation to test the potential of reducing MMP of methane-oil system using chemical additives. In addition to further coreflooding experiments to quantify the effect of the chemical-assisted MMP reduction on the ultimate oil recovery factor under different injection scenarios, which is essential to determine the feasibility of the proposed technique.
- Data analysis of existing hydrocarbon MMP data in literature to determine the dominant factors of the miscibility process, and consequently build machine learning models to accurately predict MMP in hydrocarbon gas-oil system and methane-oil system for the first time in the literature.

1.3 Thesis Organization and Outlines

The structure of the thesis consists of nine chapters in order to achieve the outlined research objectives including the introduction, literature review, research methodology, results and discussion (five chapters), and the last chapter is the conclusion and recommendations for future work.

A short description of the contents of all nine chapters is presented below.

Chapter 1- Introduction

This chapter is divided into three sections. The first section introduces a background about the importance of gas injection as an EOR technique and technical challenges associated with miscible gas injection. The second section presents the research objectives and the different stages of research to achieve these objectives. The last section of this chapter presents an overview of the structure and organization of the thesis.

Chapter 2- Literature Review of Chemical-Assisted MMP Reduction

The main objective of this chapter is to provide a literature review of the existing chemical assisted MMP reduction trials on CO₂-oil system, and to highlight the gap in the literature regarding the lack of similar approaches for MMP reduction in hydrocarbon gases.

Furthermore, the chapter covers the basic definitions of miscibility and minimum miscibility pressure (MMP), in addition to an overview of the most common MMP measurement methods.

Chapter 3- Research Framework and Methodology

This chapter presents an overview of the structure of the research methodology. In particular, the chapter covers more details regarding the used experimental methods and their role in achieving the research objectives.

Chapter 4- Chemical-Assisted Minimum Miscibility Pressure Reduction between Oil and Methane, Journal of Petroleum Science and Engineering, 2021. 196.

This chapter presents a novel experimental investigation and discussion about the potential of chemical assisted MMP reduction in methane-oil system for the first time. In this chapter, the effect of chemical additives on the interfacial tension of the methane-oil system was tested using four different chemicals (surfactant and alcohol-based chemicals) under different pressure and temperature conditions.

Chapter 5- *Effect of Functional Groups on Chemical-Assisted MMP Reduction of a Methane-Oil System, Energy & Fuels, 2021. 35(18): p. 14519-14526.*

This chapter presents a systematic experimental study that investigates the effect of the functional head group and hydrocarbon chain length on the miscibility of the methane-oil system using six different synthesized chemical additives. The aim of this chapter is to determine the controlling factors of the miscibility process and to provide some guidelines to synthesis an effective chemical for chemical-assisted MMP reduction technique.

Chapter 6- *Chemical-Assisted MMP Reduction on Methane-Oil Systems: Implications for Natural Gas Injection to Enhanced Oil Recovery, Petroleum Journal, 2022.*

This chapter presents and discusses the results of a series of coreflooding experiments using pure methane, chemical-assisted methane, and methane/CO₂ mixture as injection gas to recover crude oil at core scale. The aim of this chapter is to examine and quantify the effect of chemical assisted MMP reduction on the ultimate oil recovery factor under different scenarios which consequently determines the feasibility of the process.

Chapter 7- *Data Analysis of MMP in Hydrocarbon Gas-Oil System*

This chapter presents an exploratory data analysis using a wide range of hydrocarbon gas-oil MMP data. Firstly, a comprehensive database was collected to visualize and analyse MMP behaviour with different input parameters. Further, a brief overview of the existing correlations and its limitations is presented.

Chapter 8- *Machine Learning to Predict MMP in Hydrocarbon Gas-Oil Systems*

This chapter utilizes the conclusion of the previous chapter (Data analysis) to build a reliable machine learning model to predict MMP in hydrocarbon gas-oil system. Multi-layer perceptron (MLP) and support vector regression (SVR) machine learning algorithms were

utilized to build machine learning models to predict MMP in hydrocarbon gas-oil and methane-oil systems.

Chapter 9- Conclusion and Recommendations

This chapter presents a summary of the research program and the novel findings of this work, and then based on the experimental results, provides a list of its key conclusions. It also provides recommendations for future research to be conducted in the same area.

Chapter 2 Literature Review of Chemical-Assisted MMP Reduction

2.1 Enhanced Oil Recovery (EOR)

Hydrocarbon resources, in particular oil and gas, remains essential in the rest of the 21st century in order to meet the increasing global energy demand [2-4]. Typically, only up to one third of the original oil in place (OOIP) is recovered after the secondary recovery process [2, 5-8]. Therefore, more than two thirds of the OOIP remains in reservoirs. To further unlock the remaining oil resources, several enhanced oil recovery (EOR) techniques (e.g., Thermal-EOR, Chemical-EOR, Carbon dioxide (CO₂) flooding) have been proposed and applied in fields with a significant output of the incremental oil recovery, as shown in Figure 2.1. To be more specific, there is a continuous increase in the global attention for gas injection EOR projects, especially CO₂ injection which has been identified as a cost-effective and environmentally friendly approach to further enhance oil recovery by decreasing interfacial tension and boosting reservoir energy by swelling in-situ crude oil [9-11].

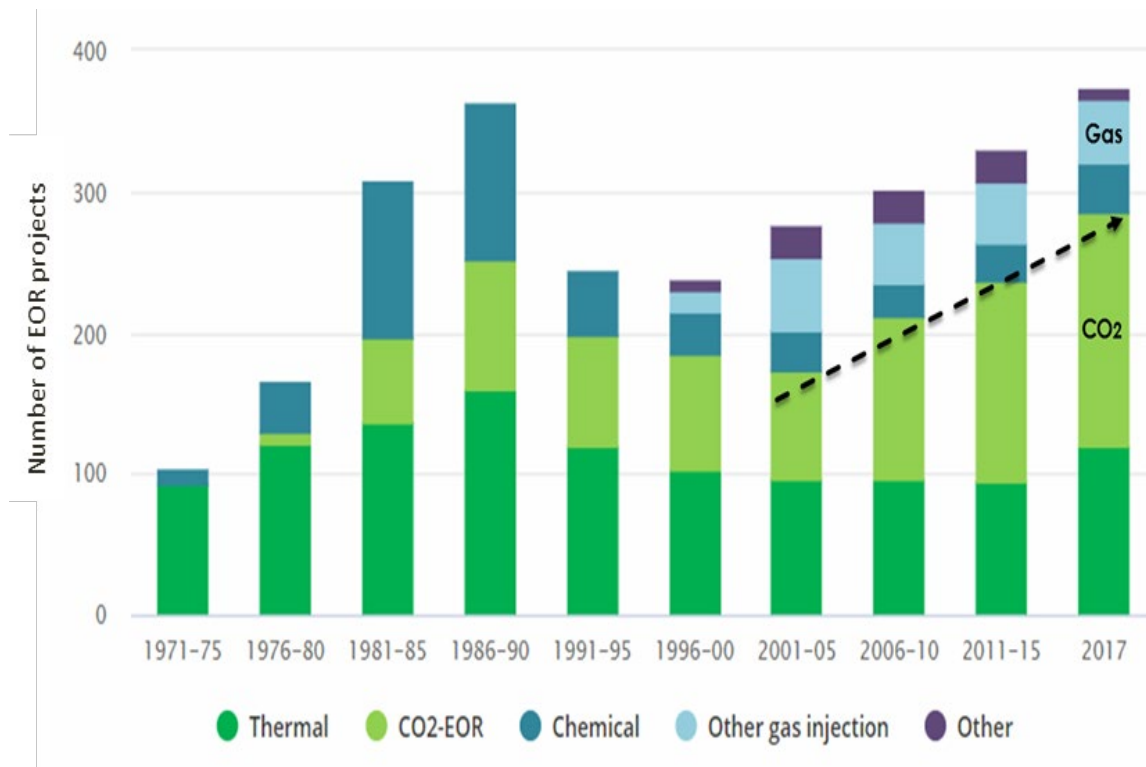

Figure 2.1 Number of EOR projects worldwide [12]

2.2 Miscibility

CO₂ injection is the most widely applied EOR method for light and medium crude oil recovery in carbonate and sandstone reservoirs [13-15]. In this method, the gas is injected into the reservoir to maintain the reservoir pressure along with improving microscopic efficiency through oil swelling and lowering oil viscosity and thus improve oil recovery [16-19]. The injected gas may include mixtures of hydrocarbons from methane to propane, and nonhydrocarbon gases such as CO₂ and N₂ [20]. However, the incremental oil recovery achieved by gas injection would be greater, up to 10% or even more, while the process is operated under miscibility conditions [21-25]. The miscibility between injected gas and crude oil occurs in the reservoir through in-situ compositional changes as a result of multiple contacts while the injected gas moves through the reservoir [25]. In order to achieve a miscible condition, the interfacial tension between oil and gas phases needs to be reduced significantly from the original value to almost zero, which allows gas and oil phases to

become a single phase, resulting in improved sweep efficiency and recovery factor [26] as illustrated below in Figure 2.2.

Miscibility between gas and oil phases can be formed through (1) first contact miscibility, which is achieved while both fluids are completely miscible in all proportions [7, 27, 28], or (2) multi-contact miscibility when the miscibility is achieved through several contacts between the injected gas and crude oil, which is sub-divided into two processes: condensing gas drive and vaporising gas drive, where the injected gas is enriched through the extraction (vaporisation) of the light and intermediate crude oil components, then the enriched gas is dissolved (condensed) into the crude oil, where a miscibility (transition) zone is formed between gas and oil phases [29, 30]. The miscibility is improved when the pressure increases as the distance between CO₂ molecules decreases and the interaction force between the molecules increases significantly. The same effect occurs with crude oil but with much less significance due to the fact that the crude oil is much less compressible compared to CO₂ [31, 32].

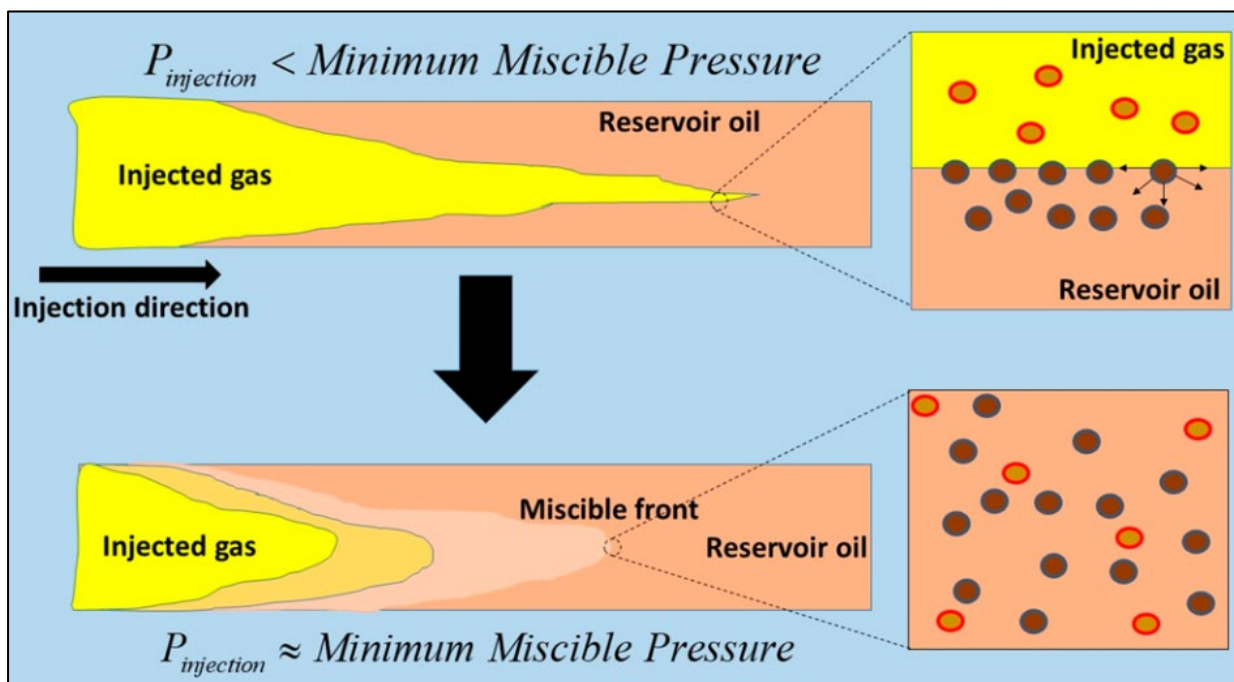

Figure 2.2 Miscibility schematic diagram [33]

2.2.1 Minimum Miscibility Pressure (MMP)

The MMP is dependent on many factors such as reservoir temperature, reservoir pressure, the composition of crude oil, and the injected gas composition [34, 35]. Two approaches have been proposed to reach the miscibility during CO₂ flooding, such as (1) increasing gas injection pressure to reach the MMP value, and (2) decreasing MMP by changing the injection gas composition, for example, adding chemicals or other gases in order to make the miscibility achievable at the same injection pressure and reservoir temperature [36]. In this context, increasing gas injection pressure can improve the miscibility between the gas and crude oil at the same temperature [32]. To be more specific, this process can change the condition from immiscible to multi-contact miscibility and can also possibly shift multi-contact miscibility to first contact miscibility. However, some limitations remain in this process [37]. For example, the increased injection pressure may exceed the formation fracture pressure to reach MMP, which is not practical in field implementation. Moreover, increasing pressure to a certain value would definitely increase the operation cost, which might not be a cost-effective process.

2.3 MMP Measurement Methods

Determination of the minimum miscibility pressure (MMP) in gas-oil system is a critical factor to evaluate the potential of miscible gas flooding. Therefore, several experimental procedures were proposed to accurately determine the MMP value. This section presents a review of the most widely used experimental approaches to identify the MMP.

2.3.1 Slim Tube Test

Slim tube test is the most widely used method for MMP measurement and it is considered by the industry as the standard experiment to measure the MMP due to its accuracy [38]. The slim tube method provides more data about oil recovery and breakthrough time as well.

Furthermore, slim tube can determine the change in produced fluid density and composition through the analysis of the effluent liquid [39].

The design of the slim tube was first suggested by Yelling and Metcalf, 1980 [38] and it depends on certain parameters. First, tube length, which should be long enough (normally between 12 and 20 m) to provide room for miscible displacement to be achieved [40, 41]. Second, tube diameter, which should be thin enough (normally between 1/4" and 3/8") to eliminate possible viscous fingering occurrence [40, 42]. Third, the packing material which controls the porosity and permeability of the system. In the literature, the tube is normally packed with fine sand or glass beads with size ranges between 60 to 200 mesh. A schematic of slim tube equipment setup is shown in Figure 2.3.

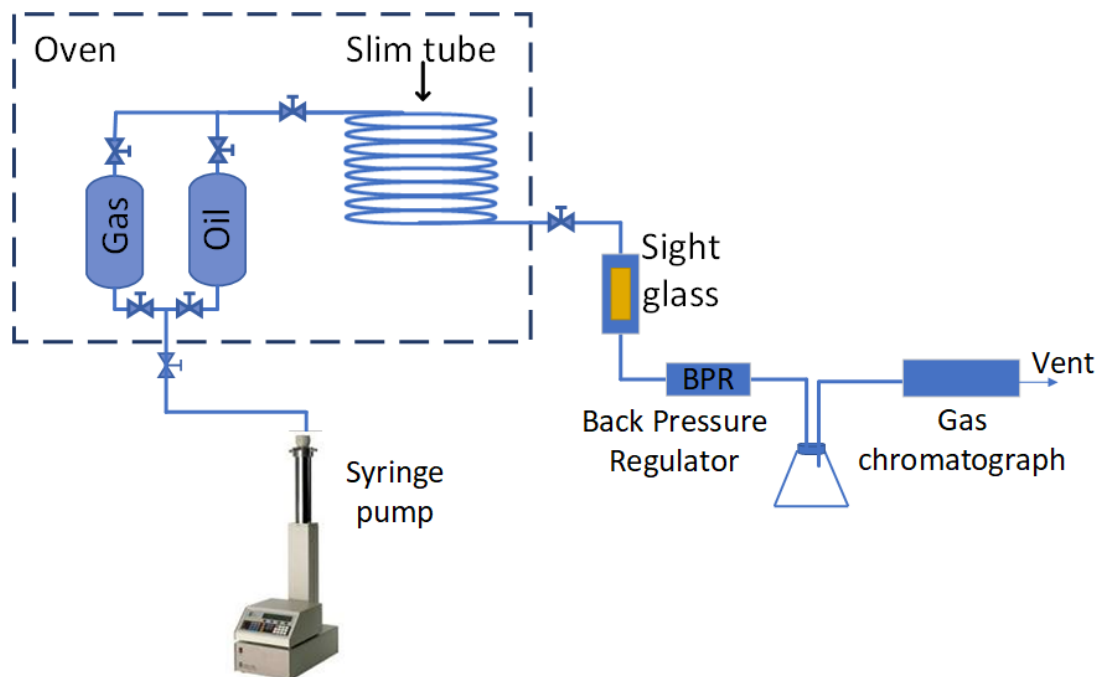

Figure 2.3 Schematic diagram of slim tube equipment

The slim tube experiment starts by saturating the slim tube with crude oil at the required temperature and pressure followed by 1.2 pore volume of gas injection to measure the recovery factor [34, 43]. The MMP is calculated as the pressure required to achieve a recovery of 90% at 1.2 hydrocarbon pore volume (HCPV) of gas injection [44-47]. Four

experiments at least would be required to determine the MMP value, two experiments below the MMP and another two experiments over the MMP, then two lines are drawn and the breakpoint of this curve indicates the transition from immiscible to miscible flooding, and the pressure at this point is considered the minimum miscibility pressure. However, there is no standard design or procedure for the slim tube experiment [48] including tube length, tube diameter, packing material, porosity and permeability. In literature, several studies were performed to investigate the effect of the design parameters on the MMP value. For example, Glaso [49] tested the oil recovery by nitrogen gas injection using different tube lengths (12, 24 and 36), he reported a significant increase in oil recovery with increasing the slim tube length. In another study, Ekundayo et al. [50] performed several slim tube experiments using different flow rates, tube inside diameters and tube lengths to measure the MMP in natural gas-oil system. They concluded that MMP value decreases with increasing tube length from 12 to 24 m, they also reported a lower MMP for the larger inside diameter (0.18" compared to 0.12"), where the effect of gas injection flow rate did not have a clear trend with MMP value.

The slim tube method has some associated disadvantages [50, 51]. Besides having no standard design, there is no standard procedure in terms of flow rate or criteria for measuring MMP. However, the main concern with this method is being expensive and time consuming, as a single experiment could take between 2 and 6 weeks to estimate the MMP.

2.3.2 Vanishing Interfacial Tension

Vanishing interfacial tension (VIT) technique has been considered by many researchers as a well-validated method to estimate the MMP compared to the traditional slim-tube method [46, 52-54]. The VIT method provides a fast, economic and reliable approach to determine the miscibility pressure in the gas-oil system [13, 55]. A schematic diagram of the IFT equipment is shown in Figure 2.4. In this method, the gas is injected and pressurized into a

high-pressure cell, then the cell is heated to the desired experimental conditions. Then, an oil droplet is introduced into the system and the interfacial tension between gas and oil phases is calculated based on the drop shape using the axisymmetric drop shape analysis (ADSA) technique [19, 56]. The equilibrium IFT measurement is repeated at different pressure points at the same temperature. Then the data is extrapolated using linear regression to estimate the value of zero interfacial tension, based on the concept that the miscibility is achieved when the IFT is eliminated between two different phases.

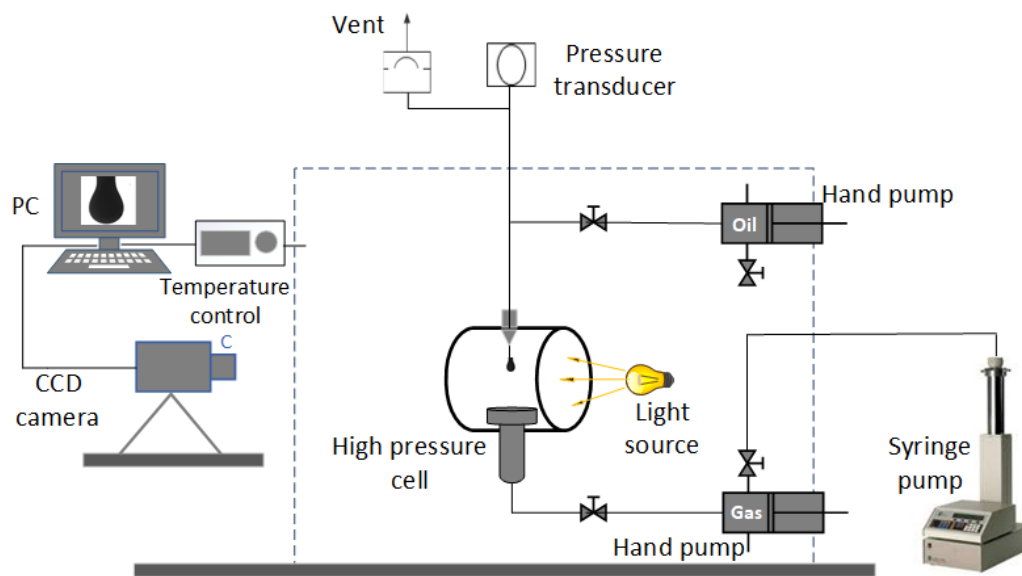

Figure 2.4 Schematic diagram of IFT equipment

The MMP and first-contact miscibility (FCM or P_{max}) pressures under reservoir conditions can be identified based on the IFT slope [29, 57]. The IFT curve generates two different slopes depending on the oil composition. In the first pressure region, the lighter components from the oil pendent drop are extracted by the gas, where the intersection of the extrapolated IFT values in the first region with the pressure axis represents the MMP value. In the second region, the heavier oil components require a higher pressure to be extracted, thus the slope of the IFT curve changes more slowly with increasing pressure, where the intersection of the

extrapolated IFT values in the second region with the pressure axis represents the FCM value [30, 35, 58].

In the literature, some studies reported low accuracy in MMP estimation using VIT in the gas-oil system. For example, Kristian et al. [59] reported that the IFT values resulting from extrapolation of low IFT values are least accurate in the gas-oil system when there is a high difference between MMP and FCM, and they concluded that the VIT is not a reliable single source for MMP estimation in the gas-oil system. Furthermore, several researchers suggested that the VIT method overestimates the MMP values measured by slim tube experiment in CO₂-oil system [34, 55, 60].

Based on the literature, the VIT remains a well-validated and a reliable technique to initially predict the MMP and FCM values, in addition to being a fast and economic method. However, for more accurate determination and for additional data about the miscibility process the traditional slim tube method could be recommended.

2.3.3 Rising Bubble Apparatus

The rising bubble apparatus (RBA) is a commonly used method to visually determine the MMP as it is considered a reliable and fast alternative to the slim tube method [61-63]. This approach consists of a vertical high pressure sight glass tube with a controlled temperature. Initially, the glass tube is filled with oil and heated and pressurized up to the desired conditions. Then gas bubbles would be injected into the tube from a needle at the bottom of the sight gauge as shown in Figure 2.5. Then, the shape of the produced gas drop would be recorded and analysed using a camera attached to the equipment setup [40, 64].

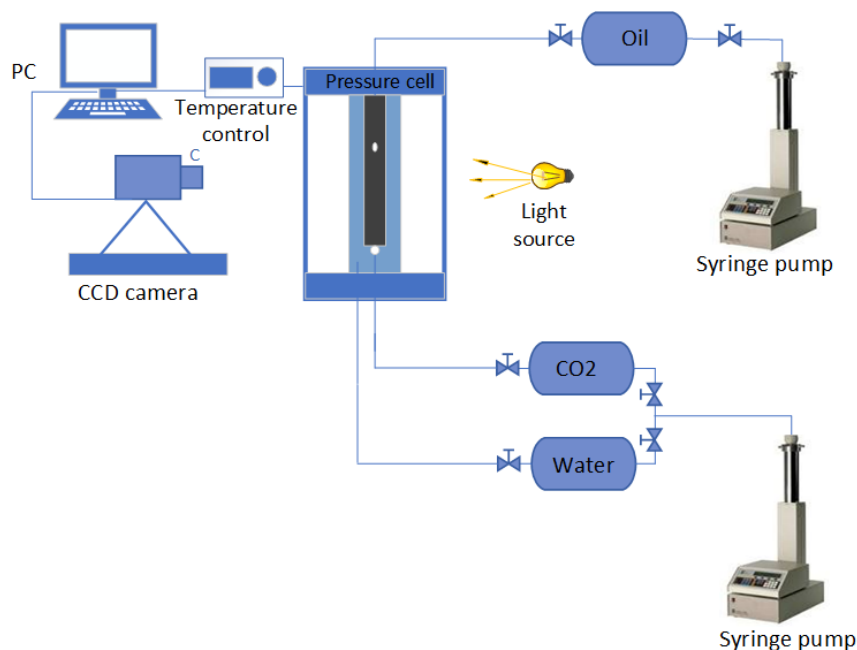

Figure 2.5 Schematic diagram of rising bubble apparatus (RBA)

In this method, The MMP is determined through monitoring and interpreting the dynamic behaviour of the gas bubble (e.g., bubble size, shape, and height) while travelling through the oil column [64, 65]. For example, at the immiscible conditions, the shape of the injected gas bubble is spherical and then evolves into ellipsoidal with increasing the pressure. When the pressure is increased to the MMP, the bubble may still be spherical with a gradually formed tail at the bottom. While the bubble may vanish or immediately disappear at the first contact miscibility pressure [64].

This visual observation of the miscibility allows a fast determination of the MMP within a reasonable accuracy compared to the slim tube method [48] where the experiment can take only few hours to complete. Zho and Orr [66] concluded that the RBA method could be used to measure the MMP during vaporising gas drive process, but this approach is less accurate in condensing gas drive. However, the main drawback of this method is that it cannot provide a quantitative data to support the results due to being only dependent on visual observation.

2.4 Trials of Reducing MMP in CO₂

Reducing MMP by adding chemical additives into gas phases appears to be an emerging technique to achieve miscible flooding process thus enhance oil recovery [67]. Although to the best of our knowledge, there is no reported field application for this technique. However, a few studies at laboratory scale show that adding a certain concentration of chemicals into CO₂-oil systems leads to up to 22% MMP reduction [68-70] implying a promising perspective to unlock remaining hydrocarbon in fields. In this work, we performed a comprehensive review on chemical-assisted MMP reduction across a wide spectrum of evaluation methodologies and chemicals. To be more specific, we reviewed the advantages and disadvantages of the most common implemented methodologies to measure the MMP, e.g., rising bubble apparatus, vanishing interfacial tension technique and slim tube experiment. Moreover, we reviewed the published work to reduce the MMP using various chemical additives, e.g., alcohols, fatty acids and surfactants. Furthermore, we summarized the effect of different gas impurities on the miscibility pressure of CO₂-oil system.

2.4.1 Chemical-Assisted MMP Reduction

Literature shows that the addition of a fraction of some chemical additives can reduce the MMP in the CO₂-crude oil system thus improve miscibility behaviour at reservoir conditions. In the following subsections, chemicals which have been tested are reviewed and discussed.

In this work, we aim to provide insights into minimum miscibility pressure (MMP) reduction by adding chemicals into CO₂ phase during injection. We achieved this objective by performing a comprehensive review on chemical-assisted MMP reduction using different chemical additives (e.g., alcohols, fatty acids, surfactants) and different experimental methodologies.

Previous experimental studies have shown that a fraction of chemical additives can yield up to 22% of MMP reduction in CO₂-oil system. Based on results analysis, surfactant based chemicals were found to be more efficient compared to alcohol based chemicals in reducing the interfacial tension in the CO₂-oil system. Based on the current experimental results, adding chemicals to improve the miscibility and reduce the MMP in the CO₂-oil system appears to be a promising technique to increase oil recovery while reducing operating cost. Selection of the effective chemical additives may help to expand the application of miscible gas injection to shallow and high temperature reservoirs. Furthermore, our review provides an overall framework to screen potential chemical additives and an injection strategy to be used for miscible displacement in CO₂ and/or gas systems.

2.4.1.1 Alcohols

Alcohols which are semi-polar solvents [71] has been used in the petroleum industry because of its ability to dissolve nonpolar substances. Addition of alcohols into CO₂-oil system increases the viscosity and density of the displacing fluid (CO₂) while reducing the viscosity and density of the crude oil (displaced fluid) [72], thus reducing the IFT between the two fluids and improves the miscibility. Upon adding the alcohol into gas-oil system, gas and crude oil (non-polar) attach to the non-polar end of the alcohol. This process would enhance the solubility of gas thus reducing the interfacial tension between the gas and crude oil.

In a recent study, Yang et al. [32] investigated the effect of adding a 5 wt% of monohydric alcohols (1-butanol, 1-pentanol and 1-hexanol) on the miscibility between CO₂ and crude oil using the vanishing interfacial tension technique. They examined the effect of pressure on CO₂ solubility with and without alcohols at 343.15 K. Their results show that increasing pressure increases CO₂ solubility in crude oil especially under relatively higher pressures regardless of the type of the alcohol. For a system without alcohols, CO₂ solubility also increases with pressure, and this could be due to the decrease of the intermolecular forces of

crude oil with increasing the pressure. However, adding alcohols indeed helps to extract the heavy components of the crude oil and to increase the CO₂ solubility. It worth noting that, increasing carbon chain in the alcohol increases CO₂ solubility in crude oil up to a certain limit. This could occur due to the fact that longer carbon chain yields an increase in the contact area with crude oil in particular asphaltene, and thus forms a stronger interaction with crude oil through intermolecular forces.

Besides, Yang et al., have also examined the effect of adding 5% of alcohol mixture (1-butanol, 1-pentanol and 1-hexanol with a volume ratio of 8:1:1) on the interfacial tension between CO₂ and crude oil. They observed a 9.21% reduction in the MMP compared to the original case without adding alcohols. They attributed the reduction to the synergistic effect of the different alcohol types (different carbon chain length) which improves the solubility and volume expansion, where alcohol with short carbon chain extracts the light crude oil components and the alcohol with long carbon chain has more impact on extraction of heavy oil components [73].

In another work, Moradi et al., [74] investigated the effect of 5 commercial alcohols with different concentrations (2.5 wt%, 5 wt% and 10 wt%) on the interfacial tension between crude oil and carbon dioxide using pendant drop method over pressures up to 16.55 MPa at 375.15 K. The tested chemicals were ALFOL 1214 (C₁₂H₂₆O), ISOFOL 12 (C₁₂H₂₇O), ISOFOL 16 (C₁₆H₃₄O), ISOFOL 28 (C₂₈H₅₈O), LIAL 123A (C₁₂–C₁₃, C₂ Mono branched alcohol). Their results show that tested alcohols have been effective in reducing the IFT between the crude oil and CO₂. They also reported that branched alcohols resulted in a higher IFT reduction compared with linear alcohols with same number of carbon chain. This is supported by the hypothesis that alcohols with branches likely help to increase the contact area between the CO₂ and crude oil and thus enhances the solubility of CO₂ in the oil and reduces the interfacial tension [75, 76]. However, the branching of alcohols for reducing the

IFT may be negligible after reaching a certain carbon chain length. In other words, the increase of the carbon chain length or branches may not have an increasing impact on reducing IFT after reaching a certain carbon chain [75].

2.4.1.2 Fatty Acids

Carboxylic acid has been also used to improve the miscibility in the CO₂-crude oil system due to the presence of the carboxyl polar tail [77]. The presence of branching and polar functional groups such as hydroxyl, carboxyl, and carbonyl help in enhancing the solubility of CO₂ into crude oils. Fatty acid methyl ester (FAME) is a type of fatty acid ester that is produced from transesterification of fatty acids, and it has high solubility in CO₂ [78].

The effect of fatty acid methyl ester (FAME) on MMP reduction in CO₂-oil system has been tested by Qayyimah et al. [79] using slim tube method. The Experimental pressure ranges from 18 to 31 MPa at 90 °C using crude oil sample with API 42.90. They reported that the addition of 5% vol. of rubber seed oil methyl ester resulted in 4% MMP reduction. However, the reported MMP reduction is considered minor compared to other chemical additive like surfactants or alcohols despite using high fatty acid concentration.

2.4.1.3 Surfactants

Surfactant (surface active agent) molecules are amphiphilic in nature [2], where it is characterized with two functional groups, the hydrophilic head and hydrophobic tail [80]. Surfactants are used in different EOR applications due to its ability to decrease the interfacial tension and to alter reservoir wettability. A surfactant can reduce the interfacial tension force by getting adsorbed at the interface between two liquids or liquid and a gas [81] and thus decreases the capillary pressure and allows water to move the trapped oil. There are different types of surfactants used in EOR applications depending on the type of the hydrophilic head group like anionic, non-ionic, cationic and zwitterionic surfactants [82].

In carbonate rock, using cationic surfactants is preferred due to its ability to alter the carbonate rock wettability from oil-wet to water-wet system, where the negatively charged components of the crude oil are adsorbed into positively charged minerals on carbonate rock surface. When the surfactant is introduced into the system, the ion pair formation interaction occurs between monomers of the surfactant and anionic components of the oil, resulting in desorption of the oil phase from the rock surface and altering rock wettability [2, 83-85]. In contrast, using anionic surfactants is preferred in sandstone reservoirs because of the likeness of their charge which makes them efficient for the respective rock system.

Several investigations have been performed to address the influence of the head and tail group type and structure on the ability of surfactants to improve solubilising power of supercritical CO₂ for EOR application [86]. It was found that using fluorocarbon chain as a tail group can improve the miscibility of CO₂, however it is not utilized in the industry due to being expensive and hazardous [71, 87, 88]. Polyoxypropylene, polyoxyethylene and carbonyl groups are among the other proposed CO₂-philic groups to improve the solubility between CO₂ and crude oil.

The effect of surfactant on reducing the MMP in the CO₂-oil system has been investigated in few recent studies. For example, Luo et al. 2018 [70] examined the effect of non-ionic surfactants to reduce the MMP and the interfacial tension between the CO₂ and crude oil system using vanishing interfacial tension technique. Their results show that the addition of 0.6 wt% of propoxylated surfactants in CO₂ yielded a reduction in the MMP from 19.1 to 13.8 MPa (27.7% reduction) and a significant reduction in first contact miscibility from 43 to 19 MPa. The reduction of the IFT could be attributed to the interaction between CO₂ molecules and Oxypropylene group (CO₂-philic) in the tested propoxylated surfactants, where the crude oil molecules are attached to the carbon chain of the surfactant. This

arrangement can significantly eliminate the difference of intermolecular forces from the two phases for the molecules at the interface and reduce the interfacial tension [89].

In another work, Guo et al. [68] investigated the effect of a synthesized oil-soluble liquid surfactant (CAE) on the MMP using slim tube method under a pressure ranging from 18 to 30 MPa at 85 °C. They report a 6.1 MPa (22%) reduction in the MMP using 0.2 wt% as a pre-slug in the slim tube experiment. Based on their experiments, they concluded that adding the chemical as a pre-slug leads to higher recovery factor compared to mixing the chemical with CO₂ injection stream.

Furthermore, Rommerskirchen et al. [36] examined the potential of five surfactant based chemicals (ME-1, ME-2, ME-4, ME-5 & ME-6) to reduce the MMP between CO₂ and crude oil using pressure resistant visual observation cell. Their experiments were performed with a model oil with the following composition (41 wt% paraffins, 8 wt% aromatics, 21 wt% naphthenes, and 30 wt% wax) at 65 °C. The original MMP and reduced MMP is shown in Table 2.1. As per the MMP results in Table 2.1, the achieved MMP reduction using the selected chemical is ranging between 870 psi for (ME-4) and 1117 psi for (ME-1), which represents 16% and 21% respectively. It worth noting that the solubility of the chemical additives didn't reflect the MMP reduction. For example, ME-6 had the highest solubility in CO₂, but it didn't yield the highest MMP reduction. The experiments were repeated using light Asian crude oil with an API of 38° at a constant temperature of 65 °C. They reported a reduction of MMP between 10 – 18% using 2 wt% of chemical additives for the light Asian crude oil, which suggests the significant impact of crude oil composition on the MMP reduction.

Table 2.1 Summary of MMP reduction using different chemicals

Additive	MMP _p (psi)	ΔMMP _p (psi)
no additive	5294	-
2 wt% ME-1	4177	1117
2 wt% ME-2	4119	1175
2 wt% ME-4	4424	870
2 wt% ME-5	4293	1001
2 wt% ME-6	4235	1059

Based on the preceding experimental results it is obvious that synthesising an effective chemical is essential to improve the miscibility in gas-oil system. Where the selection of head and tail groups (CO₂-philic and lipophilic) and optimising carbon chain length is related to the crude oil composition and its heavy components content. For example, long carbon chain in the lipophilic tail group may help to extract more heavy oil components, thus improve the miscibility. Similarly, in light oil conditions, short carbon chain will easily extract light crude oil components. In addition, optimising chemical concentration appears to be necessary to achieve miscibility within economical limits. In other words, increasing chemical concentration does not necessarily mean more MMP reduction. Moreover, chemical injection strategy needs to be designed for each individual project based on reservoir condition as it has a significant impact on oil recovery, core flooding experiments and reservoir simulation tools could provide a good input in this case.

2.4.2 Gas Impurities Effect

Presence of gas impurities in CO₂ injection stream has a significant effect on the oil recovery of CO₂ flooding. Generally, the contamination of CO₂ by CH₄ or N₂ can increase the MMP, whereas the presence of C₂H₆, intermediate hydrocarbon or H₂S can reduce the MMP [90].

CO₂ is rarely pure in the field operations, where it usually contains N₂ and other flue gases. The process of purifying the gas will be associated with additional cost which may affect the feasibility of the project. Therefore, it is important to understand the effect of gas impurities on the miscibility pressure of CO₂ gas injection to determine the feasibility of removing the impurities from the recycled gas. In this context, Zhang et al. [91] investigated the effect of different impurities and concentrations on the MMP in the CO₂-oil system using the rising bubble apparatus (RBA). The results show that CO₂ contaminated by C₁ or N₂ has a negative impact on the MMP. In contrast, the addition of C₂ - C₄ and H₂S had a positive impact effect on reducing the MMP value. The list of tested gas compositions and their effect on the MMP are shown in Table 2.2.

Table 2.2 List of tested gas impurities [91]

Gas	Composition	MMP (psi)	MMP% change
Gas 1	Pure CO ₂	1697	-
Gas 2	94.1%CO ₂ + 3.1%N ₂ + 2.8% CH ₄	2103	23.9%
Gas 3	90.1%CO ₂ + 9.9% CH ₄	2321	36.8%
Gas 4	89.8%CO ₂ + 5.1%N ₂ + 5.1% CH ₄	2973	75.2%
Gas 5	70%CO ₂ + 30% H ₂ S	1508	-11.9%
Gas 6	70%CO ₂ + 30% SO ₂	1262	-26.3%
Gas 7	85%CO ₂ + 15% N ₂	4786	179.7%
Gas 8	65%CO ₂ + 15%N ₂ + 20% SO ₂	4931	188.1%
Gas 9	80%CO ₂ + 5%N ₂ +5%O ₂ + 10% SO ₂	3263	90.7%

In another work, Hawthorne et al. [53] used the capillary rise VIT method to measure MMP values in CO₂-oil system in the presence of methane or ethane with different concentrations. They reported a significant increase in the MMP in the presence of methane, and a significant

decrease in MMP in the presence of ethane. For example, The MMP of the tested crude oil (API 38.7°) at 110 °C increased from 2,540 psi with pure CO₂ to 3,430 psi with 43% methane, and to 4,510 psi with pure methane. However, with the addition of ethane at the same conditions, the MMP decreases from 2,540 psi to 2,197 psi with 22% ethane, and to 1,500 psi with pure ethane. The results also suggest that the effect of methane on the MMP is not significant when the concentration of methane is below 10 mole%, where the presence of methane reduces bulk gas viscosity and density which makes the gas less compressible, resulting in a higher miscibility pressure.

In another study by Hawthorne et al. [92], they used the capillary rise (VIT) method to determine the MMP of CO₂ and different hydrocarbon gases for four different crude oils at temperatures ranging from 28 to 127 °C. The results showed that the propane achieved the MMP at the lowest pressure with all crude oils, followed by ethane, then CO₂, where the methane resulted in the highest MMP. Moreover, they estimated the MMP using several hydrocarbon gas mixtures. For instance, they indicated that a mixture of methane, ethane and propane with the ratio of 70:20:10 could achieve the miscibility at a pressure similar to the CO₂ gas, suggesting that enriching the gas stream with propane or ethane could increase the potential of miscible gas injection to shallow reservoirs. In another study, Jin et al. [13] examined the effect of methane impurities in CO₂ injection project in Bell Creek oil field using VIT method, the results show that the measured MMP increased from 1,410 psi (with pure CO₂) to 4,080 psi (with pure methane), concluding that a miscible gas injection could still be achieved in the presence of 30 mol% methane in the recycled gas where the MMP increased to 2,500 psi.

The addition of hydrocarbon enriching gases like ethane or propane to CO₂ or methane seems to be a practical method to reduce the MMP and to achieve the miscibility at the same injection pressure. Furthermore, it could expand the application of miscible gas injection to

more candidate reservoirs, including shallow reservoirs and high temperature reservoirs. Therefore, the selection of the optimum gas composition is critical factor to improve the miscibility conditions and to maximize the recovery factor. However, there are several factors affecting the selection of the optimum injection gas composition, including gas availability and reservoir conditions (e.g., reservoir temperature, reservoir pressure, injected gas composition and oil composition), therefore, gas injection process should be designed according to each specific reservoir conditions.

2.5. Summary of Existing Results

The chemical-assisted MMP reduction appears to be an effective way to increase oil recovery due to the synergistic effect between chemical and gas injection EOR techniques. Where the chemical is proposed to be injected downhole with the injected gas stream. However, the feasibility of this method depends mainly on the chemical's cost and concentration. To date, there is no field application reported for this new method. However, few experimental studies have been done to investigate the potential of certain chemical additives to decrease MMP in CO₂-oil system. The preliminary results indeed show a promising reduction of MMP (10 – 20%) using only a fraction of chemical additives. To be more specific, Table 2.3 summarizes the methodologies and experimental results of the recent experimental studies to reduce the MMP using chemical additives. Besides, Table 2.3 summarizes the performance of the various chemicals, showing that among all the tested chemicals in several studies, surfactants based chemicals resulted in the highest MMP reduction in CO₂-oil system. In particular, propoxylated surfactants which resulted in 27% MMP reduction despite its low concentration (0.6 wt.%). The improved miscibility in the presence of the propoxylated functional head groups could be attributed to the enhanced gas extraction capacity which increases the miscibility zone and assists in reducing the interfacial tension between gas and oil phases. It worth noting that, some of the published experiments reported only the IFT reduction in the

presence of different chemicals as an indication of the improved miscibility between CO₂ and oil phases (MMP reduction has not been measured), as shown in Table 2.4.

The initial results achieved to date appear to be promising and it may enable more successful applications for miscible gas injection projects. However, more experimental work needs to be done to understand the controlling factors in the miscibility process in the gas-oil system.

Table 2.3 Summary of main MMP reduction experiments

Study	Chemical additive	Conc. Wt.%	Gas inj.	Method	Oil API	Temp °C	Pressure (MPa)	MMP reduction
Z. Yang (2019)	Monohydric Alcohols mixture	5%	CO ₂	VIT	16.7	70	2 - 43.3	9.2%
Luo et al., (2018)	propoxylated surfactants	0.6%	CO ₂	VIT	-	60	4 - 43	27%
P. Guo (2017)	Surfactant	0.2%	CO ₂	Slim-tube	-	85	18 - 30	20.0%
Rommerskirch -en (2016)	Surfactant	2%	CO ₂	Observation cell	38	65	20 - 35	10% - 18%
Qayyimah M (2016)	Fatty Acid Methyl Ester	5%	CO ₂	Slim-tube	42.9	90	12.4 - 31	4.0%
Voon (2015)	Alcohol (ALFOL 1214)	10%	CO ₂	Slim-tube	-	-	15 - 30	10.6%

Table 2.4 Summary of main IFT reduction experiments

Study	Chemical additive	Conc. Wt.%	Gas inj.	Method	Oil API	Temp °C	Pressure (MPa)	IFT reduction
Y. Yang (2016)	Toluene, benzene, (DMC) and (DEC)	2% - 8%	CO ₂	Slim-tube	-	143	20	Toluene to improve the miscibility

Voon (2014)	Alcohol-based	2.5%, 5%, 10%	CO ₂	VIT	-	100	5.5 - 16.5	Reduced IFT
Moradi (2014)	Alcohols-based	-	CO ₂	Pendant drop	37.8	102	16.5	Branched alcohols reduced IFT

2.6. Knowledge Gaps

Based on the presented literature review, the following knowledge gaps in the MMP reduction technique have been identified,

- The potential of reducing MMP in methane/hydrocarbon gas-oil system has not been investigated in the literature, which limits the application of miscible methane/hydrocarbon gas injection.
- The MMP reduction mechanism is not fully understood or explained in the literature due to insufficient studies.
- The impact of chemical-assisted MMP reduction on the oil recovery factor at core scale has not been investigated for methane/hydrocarbon gas-oil systems.
- No machine learning models presented in the literature to predict MMP in methane-oil systems.

The research framework and methodology to address the research challenges are presented in more details in Chapter three.

2.7. Conclusion

This chapter presents the existing work of reducing MMP in CO₂-oil system using chemical additives, and highlights the knowledge gaps in similar studies for methane/hydrocarbon-gas oil systems.

In conclusion, chemical-assisted MMP reduction combines the benefits of chemical EOR and gas EOR methods, where the synergistic effect of eliminating the interfacial tension between gas and oil phases (chemical effect) is combined with improved sweep efficiency (gas injection effect) through achieving the miscibility at lower pressure. However, the success of this method depends on several factors, including gas availability, chemical's cost and reservoir conditions. The experimental results show that a promising MMP reduction (10 – 20%) could be achieved using a fraction of chemical additives, where decreasing the MMP by 5 – 10% could help to reach the miscibility condition at the same injection pressure, which will likely yield a higher recovery factor (up to 10%) while decreasing the operation cost. Therefore, reducing the MMP (to a value lower than the formation fracture pressure) could expand the application of miscible gas injection to more candidate reservoirs, including shallow reservoirs and high temperature reservoirs.

Based on the published work, the following conclusions can be drawn:

- Chemical-assisted MMP reduction appears to be an effective technique to improve the recovery factor in CO₂ EOR projects by achieving the miscibility conditions at a lower pressure.
- Surfactant-based chemicals were the most effective chemicals to reduce the interfacial tension in CO₂-oil systems due to its amphiphilic nature.
- Enriching gas stream with rich hydrocarbon gases (e.g., ethane and propane) could be a good alternative to reduce the miscibility pressure between CO₂ and oil.
- The successful application of chemical-assisted MMP method could increase the oil recovery factor, decrease the operating cost and reduce greenhouse gas emissions.
- More experimental work is recommended to find safe, economic and effective chemicals for MMP reduction.

Chapter 3 Research Framework and Methodology

3.1. Research Overview

The objective of this chapter is to introduce the proposed research framework to address the identified knowledge gaps in the previous chapter. As shown in Figure 3.1 below, the research methodology is structured to achieve the outlined research deliverables related to MMP reduction. Firstly, a comprehensive literature review was conducted to understand the previous MMP reduction trials in CO₂-oil system and to identify the knowledge gap regarding similar approaches in methane/natural gas-oil systems. Furthermore, the literature review section aims to summarize the potential effective chemicals to reduce the IFT and to understand the underlying gas-oil miscibility mechanisms in the presence of chemical additives. Afterwards, interfacial tension (IFT) experiments were implemented to test the potential chemical additives to reduce the MMP in methane-oil system for the first time in methane-oil system, then additional IFT experiments were performed using different chemical headgroups and hydrocarbon chains to test different combinations of synthesized chemicals, and to assist in better understanding of the miscibility mechanisms.

After gaining insights about the proposed mechanisms for MMP reduction and identifying the most effective chemical additives, the next step which highlights the feasibility of the MMP reduction technique is to quantify the impact of MMP reduction on the oil recovery factor under different injection scenarios. This objective was achieved through designing a set of core flooding experiments to compare the ultimate recovery factor under immiscible and miscible conditions using chemical additives or CO₂ gas.

Finally, we employed data science techniques to investigate the potential of MMP reduction using different input parameters (gas injection compositions) using machine learning (ML) algorithms. First, a comprehensive database of 153 MMP data points measured by slim-tube

experiment were collected from the literature. Second, exploratory data analysis was performed to understand the main controlling factors of the miscibility process. Then, machine learning models were developed and tested to predict the MMP in hydrocarbon gas-oil system and methane-oil system.

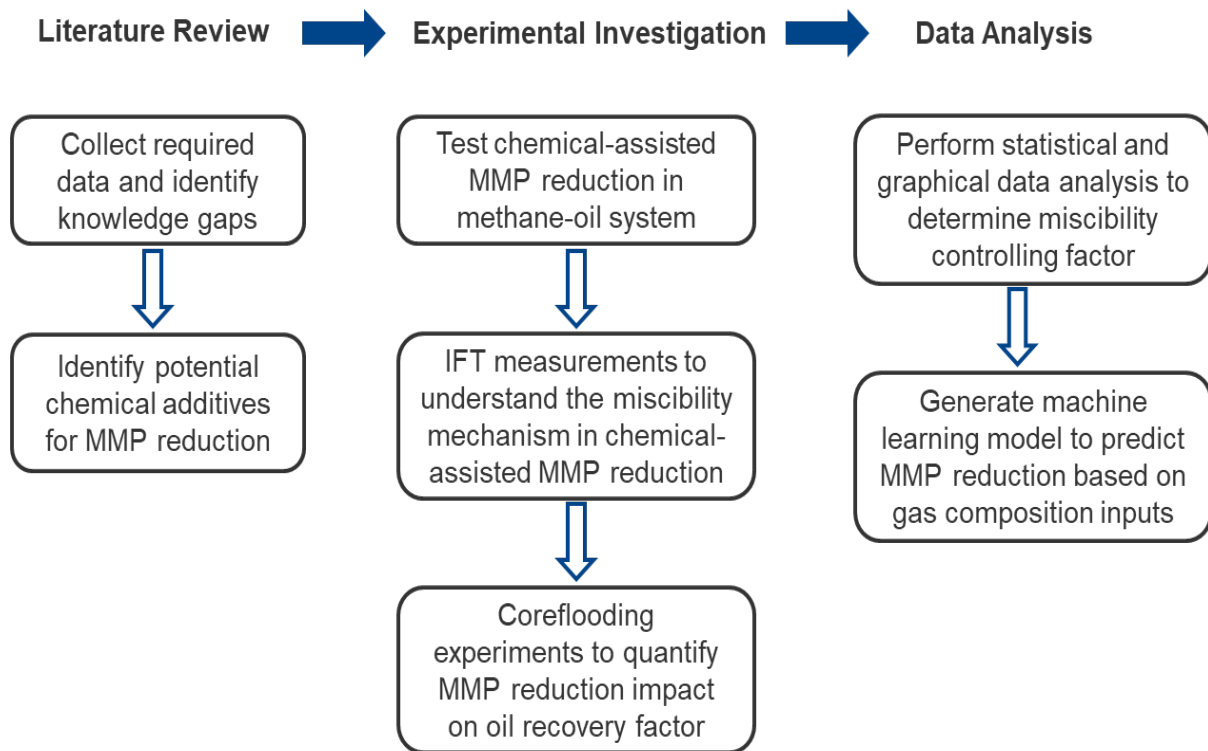

Figure 3.1 Research methodology and framework

3.2. Research Methodology

3.2.1. Interfacial Tension Measurements

Measurement of the interfacial tension (IFT) between gas and oil phases was used to determine the minimum miscibility pressure (MMP). The MMP was estimated using the vanishing interfacial tension (VIT) technique as it is widely considered as a fast and reliable method to determine the MMP. In this method, the MMP is considered to be achieved when the IFT at the gas-oil interface is measured to be zero. The used setup and measurement procedures are described in detail in Chapters 4 and 5.

Figure 3.2 below shows an example of the recorded images during IFT measurement using Vinic IFT-700 apparatus. As the figure indicates, the shape and volume of the produced oil droplet changes depending on the interfacial tension forces between the crude oil phase and the surrounding gas phase. The image on the left-hand side demonstrates an example of oil droplet when the surrounding gas pressure is less than the minimum miscibility pressure (MMP), while the image on the right-hand side shows an example of achieving the miscibility when the pressure is higher than the minimum miscibility pressure (MMP) as the oil phase mixed with the gas phase.

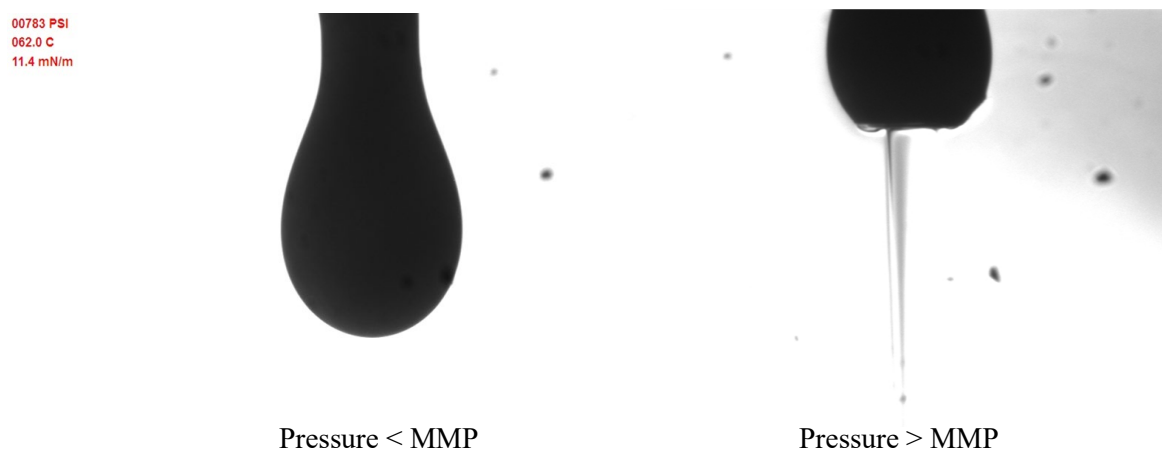

Figure 3.2 Example of IFT measurement

3.2.2. Coreflooding Experiments

After testing several chemicals and confirming the successful application of chemical-assisted MMP reduction in methane-oil system, the next step is to quantify the impact of the MMP reduction on the ultimate oil recovery factor, which is the main target of the process. Therefore, three coreflooding experiments were designed to test and compare different recovery scenarios at core scale. In all experiments, the injected pore volume was plotted against the produced oil to show the oil recovery factor at each injection stage.

In the first experiment, pure methane gas was injected under immiscible conditions as a secondary recovery method, while the chemical-assisted methane was injected in the tertiary recovery mode. The aim of this experiment is to test the potential of increasing oil recovery using chemical-assisted MMP reduction, which has not been tested or proven in the literature before.

In the second experiment, chemical-assisted MMP reduction was tested in the secondary recovery stage. The aim of this experiment is to investigate the effect of the early application of MMP reduction methodology. In other words, applying chemical-assisted MMP reduction early in the secondary recovery stage compared to tertiary recovery mode.

In the third experiment, MMP was reduced by adding enriching gas (CO_2) to the methane. This experiment aims to compare two different MMP reduction methods, chemical-assisted MMP reduction against MMP reduction using enriching gas.

3.2.3. Predict MMP in Hydrocarbon Gas-Oil System

After experimentally proving the possibility of reducing methane-oil MMP using chemical additives and confirming the promising potential of increasing oil recovery through MMP reduction (whether using chemical or using other enriching gas). The following two chapters (Chapter 7 & Chapter 8) aim to apply data science techniques to get more insights about the miscibility process in methane-oil system, then to use the insights to generate a machine learning model to predict MMP reduction based on the input gas composition.

To achieve this target, literature review of the current analytical methods to predict MMP in hydrocarbon gas-oil system has been conducted, then statistical and graphical exploratory data analysis (EDA) was performed using Python software, followed by data analysis and visualization using Tableau software. After identifying the controlling parameters of the miscibility process, Python software was utilized to test Multi-layer perceptron (MLP) and

support vector regression (SVR) algorithms to produce machine learning model that can accurately predict the MMP value based on different input parameters (gas compositions).

Chapter 4 Chemical-Assisted Minimum Miscibility Pressure

Reduction between Oil and Methane*

Abstract

Miscible gas injection is an important enhanced oil recovery technique due to favourable displacement efficiency by eliminating interfacial tension (IFT) between the injected gas and oil phases. Miscible displacement often results in far higher recovery compared to immiscible displacement. However, miscibility can be difficult to achieve in high temperature reservoirs due to high minimum miscibility pressure (MMP) with increasing reservoir temperature and in shallow reservoirs where MMP would be higher than fracture pressure. Limited studies have been performed to explore the potential of reducing MMP in CO₂-oil system using chemical additives. These additives work by collecting at the boundary between the two phases thereby reducing the interfacial tension. Specifically, none have investigated potential chemical additives to reduce the MMP in methane-oil systems, which limits the potential of methane injection. We thus investigated the effect of promising chemicals (surfactant based & alcohol based) for reducing the MMP in the methane-oil system at different temperatures (333 & 373 K) for an oil with a high acidity (4.0 mg KOH/g). Results using the vanishing interfacial tension (VIT) technique show that the tested surfactant-based chemicals reduce the MMP (methane-crude oil) by up to 9% at 373 K, whereas the tested alcohol-based chemicals have little effect on the MMP. Moreover, the results show that increasing temperature improves chemical performance and yields a higher MMP reduction, suggesting that these additives are more effective in high temperature reservoirs. The outlined research likely expands the application envelop of miscible natural gas injection in shallow and high-

* Reference: Almobarak, M., et al., *Chemical-assisted minimum miscibility pressure reduction between oil and methane. Journal of Petroleum Science and Engineering*, 2021. 196

temperature reservoirs, in addition to the environmental benefits of reducing the associated gas flaring.

4.1. Introduction

Hydrocarbon resources are still a significant part of the energy landscape and will likely remain important for meeting increasing global energy demand [2-4]. While primary and secondary recovery techniques likely recover up to 30% of the original oil in place (OOIP) [5], more than 70% of the OOIP remains in reservoirs. To further unlock the remaining oil resources, gas flooding (e.g., CO₂ and natural gas injection) has been identified as a cost-effective and efficient method, which likely yields an incremental oil recovery ranging from 10 to 25% of OOIP [93-95]. In particular, miscible CO₂ flooding has gained interest in the petroleum industry due to a lower residual oil saturation and a greater oil relative permeability compared to immiscible CO₂ flooding [21-23, 25, 96]. However, achieving miscibility during gas injection depends on various factors such as reservoir pressure, reservoir temperature, crude oil composition and gas composition [34, 35].

In order to achieve miscibility in a CO₂-oil system, the interfacial tension between CO₂ and the oil needs to be reduced to zero, i.e., reaching the minimum miscible pressure at reservoir conditions. Several mechanisms have been proposed to explain the improved oil recovery in miscible CO₂ injection process such as reduced oil viscosity, decreased interfacial tension (IFT) and oil swelling [16-19]. Generally, miscibility is achieved in the reservoir in several stages through multi-contact miscibility processes, which is divided into condensing gas drive and vaporising gas drive [28, 35]. However, for some reservoirs, miscibility is not reached during flooding due to high MMP, which may exceed the formation pressure (and its fracture limit). This problem typically occurs in shallow reservoirs due to low reservoir pressure and low formation fracture pressure compared to miscibility pressure, or it may occur in high temperature reservoirs where the MMP increases due to the increased temperature [92, 97].

Therefore, miscible gas injection is applicable and effective within certain screening criteria. The main screening criteria for miscible hydrocarbon gas injection as reported by Al Adsani et al. [98] and Taber et al. [99] are, (1) oil gravity higher than 23 API (average reported value is 38.3 API), (2) reservoir depth to be more than 4,000 ft (average reported value is 8343 ft), and (3) porosity more than 4.25 % (average reported value is 14.5%), and (4) reservoir temperature higher than 302 K (average reported temperature is 367 K). It is worth mentioning that the selected screening criteria are based on the data of 67 reported miscible hydrocarbon injection projects.

In this context, adding solvents to the gas phase may help to reduce the MMP and to push the screening criteria limits to shallow and higher temperature reservoirs, and thus improve the miscibility at the same pressure and temperature conditions. Therefore, reducing MMP by adding chemicals appears to be an emerging technique to change the gas injection process from immiscible to miscible, consequently, increases the oil recovery factor by up to 10% [21-23, 25, 96]. Several examples of research have been carried out in relation to reducing the MMP in CO₂-oil systems. For example, some of the recent published work show that adding a fraction (between 0.1 wt. % to 10 wt. %) of chemical additives (e.g. alcohols, surfactants and carboxylic acids) in the CO₂ phase can reduce MMP for CO₂-oil system by up to 22%. For instance, Luo et al. [70] investigated the effect of non-ionic surfactants to reduce the interfacial tension and the MMP in CO₂-oil system using vanishing interfacial tension technique. They reported that the addition of 0.6 wt. % of propoxylated surfactants in CO₂ yields a reduction in the MMP from 19.1 to 13.8 MPa. Similarly, Yang et al. [32] showed a 9.21% MMP reduction in CO₂-oil system by adding 5 wt. % of monohydric alcohols (1-butanol, 1-pentanol and 1-hexanol with a volume ratio of 8:1:1) using the vanishing interfacial tension technique. They also argue that the mixture of alcohol-based chemical may yield synergistic effect which improves the solubility and volume expansion. In another

work, Guo et al. [68] examined the effect of a synthesised surfactant (CAE) on the MMP reduction using a slim tube method at constant temperature of 358 K and a pressure range of 18-30 MPa. They reported MMP reduction of 6.1 MPa (a reduction of 22%) using 0.2 wt. % as a pre-slug before gas injection in the slim tube experiment. Furthermore, Rommerskirchen et al. [36] investigated the potential of five surfactant based chemicals (SOLOTERRA ME-1, ME-2, ME-4, ME-5 & ME-6) to reduce the MMP in CO₂-oil system at constant temperature (338 K) using pressure resistant visual observation cell. They reported that adding 2 wt. % of SOLOTERRA ME-6 into the gas phase results in up to 22% of MMP reduction using different crude oil compositions. The aforementioned results indicate a promising potential to reduce the MMP in CO₂-oil system by adding chemical additives, where CO₂ is a stronger solvent compared to methane due to its higher density and critical temperature (304 K) compared to methane (190 K), in addition to the presence of the quadrupole – quadrupole interactions between CO₂ molecules which operates at much shorter distance than the dipolar interactions in the methane [100]. Consequently, the miscibility is achieved at much lower pressure using CO₂ gas compared to methane.

To date, most of the published work pertaining to reducing the MMP in a gas-oil system has been performed using pure carbon dioxide gas. However, natural sources of CO₂ are not always available for gas injection in hydrocarbon reservoirs. For example, there is a lack of CO₂ resources in Western China and the Asia-pacific region. Instead, re-injection of the produced natural gas is often far preferable for enhanced oil recovery due to its low cost, availability and associated environmental benefits of reducing gas flaring. However, the main hurdle for this process is a much higher MMP between natural gas/methane-oil compared to CO₂, which leads to an immiscible flooding process at in-situ reservoir conditions thereby a high residual oil saturation as a result of a high IFT. For example, Hawthorne et al. compared the MMP of methane-oil system and CO₂-oil system using different crude oil compositions,

and they reported that the MMP of methane is between two or three times higher than those required by CO₂ [92]. Moreover, for reservoirs with high temperatures, IFT in the gas-oil system would be even higher compared with reservoirs with lower temperatures, resulting in an unfavourable displacement efficiency [42, 97, 101]. Therefore, there is a pressing need to explore the feasibility of chemical additives to reduce the MMP in natural gas-oil systems, which could likely expand the application envelop of miscible natural gas injection to more potential reservoirs. In this work, we have used pure methane to represent the natural gas in the field application. However, natural gas is typically a mixture of several hydrocarbon gases, where the presence of ethane or propane would decrease the miscibility pressure [13, 92]. Therefore, the injection of pure methane gas could be considered as the worst-case scenario in terms of miscibility pressure.

The aim of this work is to investigate the potential of different chemical additives to reduce the IFT in the methane-oil system, and thus reduce the miscibility pressure. In this context, similar to CO₂-oil system, we hypothesize that adding a chemical with a polar head group and lipophilic hydrocarbon tail could improve the solubility and reduce the MMP in a methane-oil system. In order to test the hypothesis, we examined four surfactant and alcohol-based chemicals to reduce the MMP in methane-oil system using the vanishing interfacial tension (VIT) technique at different pressures and temperatures (333 & 373 K) to determine the MMP for these systems.

4.2. Experimental Methodology

4.2.1 Materials

Oil: The oil was obtained from a wellhead in a high temperature reservoir (413 K) in Western China. The oil density under surface conditions was measured to be 0.85 g/cm³; oil viscosity was 5.23 mPa.s, and the freezing point was -20 °C. The components with the polarized ends in crude oil included wax (3.58 wt %) and asphaltene (0.54 wt %). The reservoir oil has a

base number of 1.3 mg KOH/g and an acid number of 4.0 mg KOH/g. The composition of the used dead crude oil is given in Table 4.1 as determined by gas chromatography.

Table 4.1 Compositional Analysis results of crude oil in mole percentage

Composition	mol %	Composition	mol %
CO ₂	0	C ₁₄	2.47
N ₂	0	C ₁₅	2.05
CH ₄	0	C ₁₆	1.42
C ₂	0.1	C ₁₇	1.03
C ₃	0.33	C ₁₈	0.96
iC ₄	0.36	C ₁₉	0.73
nC ₄	0.9	C ₂₀	0.49
iC ₅	1.18	C ₂₁	0.38
nC ₅	1.72	C ₂₂	0.25
C ₆	4.98	C ₂₃	0.19
C ₇	6.53	C ₂₄	0.14
C ₈	8.46	C ₂₅	0.10
C ₉	7.33	C ₂₆	0.08
C ₁₀	6.69	C ₂₇	0.07
C ₁₁	4.93	C ₂₈	0.05
C ₁₂	3.76	C ₂₉	0.04
C ₁₃	3.53	C ₃₀₊	38.75
		Total	100

Gas: Pure methane (99.9 mol %) was used as the gas phase in the experiments to mimic the field conditions. However, in the field applications, the gas is rarely pure and the presence of some impurities in the gas stream certainly affects the miscibility pressure with oil. For example, the presence of gases like CO₂, ethane or propane will enrich the methane and reduce the miscibility pressure [53, 92, 102]. In other words, pure methane injection could be considered as the worst case scenario for gas injection in terms of miscibility pressure (highest pressure required to achieve miscibility).

Chemical Additives: Typically, low molecular weight compounds combining both polar and non-polar groups will enhance the solvation power and polarity of gas. In this context, four chemicals were selected to test our hypothesis in methane-oil system, two non-ionic alkoxyated surfactants (i.e. SOLOTERRA ME-1 and ME-6) and two lipophilic alcohols (i.e. ISOFOL 16 and MARLIPAL O13). The chemicals used in this research were supplied by SASOL Performance Chemicals.

SOLOTERRA ME-6 is a propoxylated alcohol while SOLOTERRA ME-1 is an ethoxylated and propoxylated alcohol, hence also contains ethoxy units in the alkoxylation sequence. The propoxylate headgroup of the two non-ionic surfactants can be considered as rather lipophilic. Hence, in this study the amphiphilicity of the surfactants is considered between the difference of the hydrocarbon chain of the alcohol and the lipophilicity of the propoxylate headgroup. The authors deem this to be valid since the systems under investigations are free of water and therefore no hydrophilic characteristics are useful. In case of SOLOTERRA ME-1 the presence of the much more hydrophilic (or lipophobic) ethoxy units reduce the lipophilicity of the headgroup.

As shown in Table 4.2, the given chemical properties suggest that the selected chemicals are soluble in oil and have low solubility in water, as indicated by their low hydrophilic-

lipophilic balance (HLB) values, in addition to their relatively low molecular weight which assist in improving extraction process and enhancing solubility between gas and oil phases. In literature, a wide range of concentrations (from 0.1 wt. % to 10 wt. %) has been used to investigate the potential of MMP reduction using different chemical additives. In this work, chemical concentrations between 2.5 wt. % and 5 wt. % were used in the experiments.

Table 4.2 Properties of the chemical additives used in IFT experiments

Tradename	Density @ 20°C [g/cm ³]	Viscosity @ 20°C [mPas]	Refractive index @ 20°C	Mw [g/mol]	HLB (Davies)	Flash Point [°C]
SOLOTERRA ME-1	0.96	12.0	1.44	292	6.9	133
SOLOTERRA ME-6	0.93	13.0	1.44	276	5.6	-
ISOFOL 16	0.84	38.0	1.45	242	1.3	156
MARLIPAL O13	0.84	43.0	-	200	2.7	128

4.2.2 Experimental Setup and Procedures

4.2.2.1 Interfacial tension and miscibility pressure measurements

In this work, the minimum miscibility pressure (MMP) of the gas-oil system were determined using the vanishing interfacial tension (VIT) technique. The VIT method is considered as a well validated approach to determine the MMP by several researchers by comparison to the traditional slim tube technique [46, 52, 54, 55, 58, 103]. In this method, the equilibrium IFT between gas and crude oil is measured at different pressure points at constant temperature,

then the data is extrapolated to zero using linear regression, where the intercept between zero IFT and pressure axis represents the MMP value, which is the minimum pressure required to achieve multi contact miscibility [60]. This method is based on the concept that the miscibility is achieved when the IFT is eliminated between two different phases. In this work, the IFT measurements in the gas-crude oil system were conducted at a range of pressures (4 to 21 MPa) and temperatures (333 and 373 K) using the IFT700 equipment (Vinci-Technologies, France). It worth noting that the temperature of 373 K was selected to represent the high temperature reservoir condition, then the experiments were repeated at 333 K to investigate the effect of temperature on MMP and on chemical performance, where the pressure range between 4 and 21 MPa was selected as the higher pressure values result in a different decline trend to estimate the first contact miscibility (FCM) [25]. The schematic diagram of the experimental apparatus used in this study is shown in Figure 4.1, where the axisymmetric drop shape analysis (ADSA) technique were used to calculate the IFT through the pendant drop method [19, 56].

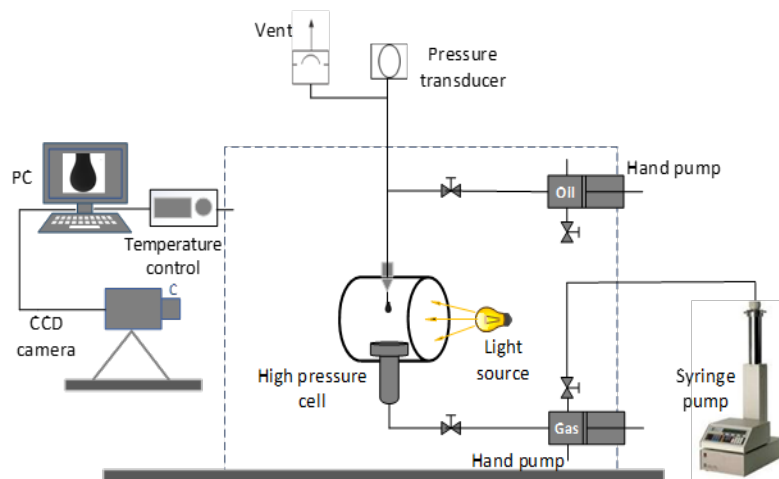

Figure 4.1 Schematic diagram for interfacial tension (IFT) measurements

Prior to each experiment, the IFT cell was thoroughly cleaned with toluene. The cell was then placed under vacuum for 12 hours to dry. Subsequently, the gas sample were slowly introduced into the IFT cell, where the gas pressure was controlled using a syringe pump until reaching the desired value. Later, the system was heated to the required temperature using the internal heater within the equipment. Then, the input parameters such as gas and oil density were entered into the software for IFT calculations. At each pressure point, an oil droplet is introduced into the system and the IFT value is calculated and recorded every 5 seconds using the drop shape analysis software, where every drop was given a sufficient time until the IFT did not vary with time. Then, another droplet is produced and the measurements are repeated (at the same pressure) to confirm experimental repeatability, the IFT results were found to be reproducible within $\pm 0.5 \text{ mN m}^{-1}$. In this study, the reported IFT is based on the average of the IFT values derived from three different oil droplets at each pressure.

Afterwards, the same process is repeated at a different pressure point to calculate another IFT value and to estimate the MMP by linear regression.

In the experiments where the chemical is used, the same procedure above was repeated with adding the required steps to mix the chemical and crude oil. First, a calculated amount of the chemical is added to the crude oil based on the weight percentage. Second, the oil-chemical mixture is stirred at 300 rpm for 2 hrs to ensure that complete mixing is achieved. Then, the mixture is transferred to the oil container in the IFT equipment.

In literature, two methods were used to mix chemical additives in the gas-oil system for IFT measurements by VIT method. First, the chemical is dissolved into the gas phase based on the weight percentage [29, 70], this method simulates the gas injection scenario in the field. However, in some cases where the solubility pressure between chemical and gas is higher than the experimental pressure, the chemical is partially dissolved and the concentration

values are not accurately determined. Second mixing method, the chemical is dissolved into the oil phase and stirred until a proper mixing is achieved [32, 69, 74, 79, 104]. In this study, mixing chemicals with the crude oil were more suitable in the experimental conditions due to the high solubility pressure between methane and the tested chemicals (around 30 MPa) compared to the experimental pressure range (5 to 21 MPa).

In the presence of chemical additives, the measured IFT values could be significantly affected by the partitioning of the chemical between the two immiscible phases (i.e. the partitioning of the additive from the gas phase to the oil phase) [105-107]. In order to minimize the possibility of differences in the IFT due to variation in partitioning, we have measured the cloud point pressure between the potential chemicals and methane at 373 K using the IFT700 equipment. As shown in Table 4.3, the measured cloud point pressures are in a close range (between 26.9 and 31.7 MPa) which suggests that the variations partitioning effect is a minor effect and any IFT change is due to the chemical interaction within the gas-oil system.

4.3. Results and Discussion

4.3.1 Effect of Pressure and Temperature on the IFT of Methane-Oil System Without Chemicals

Typically, increasing pressure decreases the interfacial tension in methane-oil system at a given temperature without adding chemicals. In this experiment we investigated the effect of the pressure on the equilibrium IFT of the methane-oil system, as shown in Figure 4.2. The results show that increasing gas pressure gradually from 3.5 to 17 MPa results in IFT reduction from 21.5 to 10 mN m⁻¹ at 333 K. Similarly, increasing gas pressure gradually from 3.5 to 16.5 MPa leads to IFT reduction from 22 to 11 mN m⁻¹ at 373 K. The IFT reduction is due to two main reasons. First, condensing of gas components into the crude oil, and the extraction of light crude oil components into gas phase [19, 29, 32, 69, 108]. Second, due to decreasing the difference of intermolecular forces between the gas and oil phases with

increasing pressure [31], where smaller difference in the intermolecular forces between oil and gas phases will result in a lower IFT. In more details, the IFT between two phases is caused by the difference between their molecular forces [109], where the crude oil has much higher intermolecular forces between its molecules due to the presence of permanent dipole force and hydrogen bonding force [70], and the methane has only the weak London dispersion forces between its molecule, therefore, there is a high IFT between methane and oil. However, increasing pressure increases the intermolecular forces between methane molecules, hence decreases the difference of the intermolecular forces between gas and oil phases and reduces the IFT [31, 110, 111].

While increasing pressure tends to decrease the IFT, increasing temperature does the opposite and leads to increase the IFT (at a fixed pressure). As shown in Figure 4.2, increasing temperature from 333 to 373 K slightly increases the IFT at a given pressure with the MMP increasing from 27.0 MPa to 29.3 MPa. Our results are in line with Hawthorne et al [53] who report that increasing the temperature from 315 to 383K results in a slight increase in the MMP of the methane-oil system from 27.5 to 31.1MPa. A similar trend was also observed by Hawthorne for CO₂-oil and ethane-oil systems with more significant effects on MMP values. For example, in the case of CO₂ and ethane the MMP increased from 8.9 to 17.4 MPa and from 4.9 to 9.4 MPa respectively with increasing temperature (from 315 to 383K). With highly compressible gas phases (or supercritical phases), increasing temperature would increase the distance between gas molecules thereby reducing the density of the gas phase, this process would reduce the intermolecular forces between the gas molecules and oil in particular light components [31, 110, 112]. The increase in the interfacial tension in all of these gas-oil systems can be mainly attributed to this phenomenon. However, compared with the oil-methane system, the intermolecular interactions between gas molecules and oils in CO₂-oil and ethane-oil systems may not fully explain the reduction in MMP. We believe that

the solubility of the gases in oil and their ability to extract light and intermediate crude oil components also leads to changes in the MMP value. In this context, CO₂ is considered a more powerful solvent due to the quadrupole – quadrupole interactions which operates at much shorter distance than the dipolar interactions in the methane [100] so it can have a higher solubility in the oil and can extract light components. In addition, the higher extraction capability of CO₂ and ethane compared to methane [29, 30] results in enhanced solubility of oil components in them.

Figure 4.2 shows that with increasing pressure there is a reduction in IFT in line with literature [108]. Where the reservoir temperature has a significant impact on the MMP value of CO₂-oil system [38], it has only a minor effect on the MMP value of oil-methane system, suggesting that methane injection could be more favourable in high temperature.

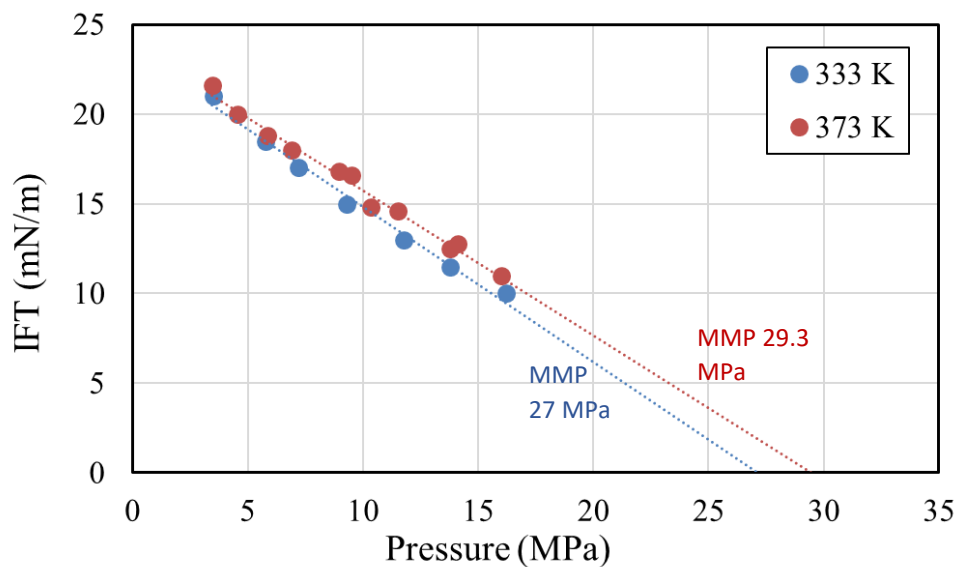

Figure 4.2 IFT in CH₄-oil system at 333 & 373 K

4.3.2 Effect of Different Chemical Additives on the IFT Reduction

4.3.2.1 Effect of Surfactant-based Chemicals on IFT Reduction for Methane-Oil System

Similar to the methane-oil systems without chemicals, adding 5 wt. % of the non-ionic surfactant (SOLOTERRA ME-6) follows the same trend that IFT decreases with increasing pressure. However, at a given pressure, adding the surfactant (SOLOTERRA ME-6) further decreases the IFT (Figure 4.3). For example, adding the chemical decreases the MMP from 29.3 to 26.65 MPa (9% reduction). The experiment was repeated using 2.5 wt. % of (SOLOTERRA ME-1) under the same experimental conditions. Similarly, the IFT decreases at a given pressure with an estimation of MMP reduction from 29.3 to 28.74 MPa (1.9% reduction).

The preliminary results suggest the potential of the tested surfactants to improve the miscibility and reduce the MMP in methane-oil system. The improved IFT reduction could be attributed to the enhanced vaporisation and condensation processes in the presence of the tested alkoxyated surfactants, where the adsorption of the surfactant molecules onto the interface between the enriched gas and oil phases assist in the development of a transition (miscibility) zone, as the head group units of the surfactant interacts with CH₄ molecules and the lipophilic tail (hydrocarbon chain) attaches to the crude oil [70, 81, 89]. which in turn reduces the difference of the intermolecular forces between the two phases, resulting in a reduction in the interfacial tension forces helping further condensing and vaporisation processes, until full miscibility is achieved. For SOLOTERRA ME-6, the presence of the propoxy headgroup in the surfactant molecules helps to extend the transition zone, and improve the mixing, thereby reduces the interfacial tension between oil and gas phases. However, for SOLOTERRA ME-1 which contains propoxy and ethoxy units, the presence of the ethoxy units which are much more lipophobic than the propoxy units, weakens the miscibility zone due to the tendency of the ethoxy groups to avoid contact with both phases

oil and gas (lipophobic), and thereby counteract the oil vaporisation, which then in return leads to reduced performance in MMP reduction. This mechanism is also associated with temperature and pressure, which also explained in the part of the effect of temperature and pressure on IFT variation.

To the best of our knowledge, we have not seen publications which explore the potential of IFT reduction of methane-oil systems through the use of chemical additives. However, our results are similar to Rommerskirchen et al. [36] who report that addition of 2 wt. % of SOLOTERRA ME-6 to CO₂-oil system results in 18% MMP reduction at 338 K using light Asian crude oil (API 38°), whereas adding 2 wt. % of SOLOTERRA ME-1 results in 10% of MMP reduction. However, it appears that the IFT reduction by adding chemical additives in oil-CO₂ systems is much higher compared to methane. The higher reduction in CO₂ system could be attributed to the fact that CO₂ is a stronger solvent due to the shorter intermolecular distance and higher critical temperature which increases quadrupole interactions [100], therefore improves its solubility in the oil phase and enhances its extraction capabilities compared to methane.

4.3.2.2 Effect of Alcohol-based Chemicals on IFT Reduction

The addition of the tested alcohol-based chemicals (with hydroxyl functional headgroup) shows a limited effect on the IFT reduction in methane-oil system. First, we examined the effect of adding 5 wt. % of the branched alcohol ISOFOL-16 (C₁₆H₂₄O) on the IFT in methane-oil system at 373 K. We observed a minor reduction in the equilibrium IFT compared to the original IFT values. The observed MMP reduction is only 1.1% (from 29.3 to 29.0 MPa). The same chemical (ISOFOL-16) has been tested by Moradi et al. [74] in a CO₂-oil system at 375 K using VIT method showing 7% of MMP reduction by mixing 2.5 wt. % of (ISOFOL-16) with crude oil. Similar to the surfactant, it appears that alcohol-based

chemical additives give a higher reduction in the CO₂-oil system compared to methane-oil system.

For MARLIPAL O13, the addition of 3 wt. % to the crude oil at 373 K resulted in a slight decrease in the IFT values at a given pressure, where the estimated MMP was reduced by only 2.9% (from 29.3 to 28.45 MPa). Similar to the other tested alcohol, the MMP reduction is considered to be minor compared to the reduction achieved by surfactant-based chemicals. The low MMP reduction by the tested alcohol based chemicals could be attributed to the lack of lipophilic head group (only hydroxyl group) and thereby limited interaction with gas phase, in addition to higher viscosity of the tested alcohols compared to surfactants (around 3 folds higher as mentioned in Table 4.2), where the viscosity reduction is one of the main factors in improving miscibility [72, 113]. Furthermore, the given hydrophile-lipophile (HLB) values indicates that surfactant has a higher tendency to interact at the gas-oil interface, as the HLB values are between 3 and 6. Moreover, the results suggest that the molecular weight of the used chemical (surfactant and alcohol based), in particular the length of the hydrocarbon chain is a critical factor in synthesising the effective chemical (alcohol and surfactant based) to improve the miscibility, where increasing carbon chain length increases the contact area with crude oil and forms a stronger interaction with crude oil through intermolecular forces, thus improves the capability of the alcohol to extract the heavy crude oil components faster [32, 73], whereas the short chain alcohols extract the light and intermediate oil components faster, thus reduces the miscibility pressure [75, 76]. It is worth noting that the performance of the used chemicals is highly dependent on the oil and gas compositions. Thus, the optimum chemical-assisted miscible gas injection project should be designed according to a specific reservoir conditions including reservoir temperature, pressure and oil composition in order to maximise the recovery factor. Table 4.3 shows a summary of the IFT experimental results at 373 K.

Table 4.3 Summary of IFT experimental results in methane-oil system at 373 K

Chemical	Concentration (wt. %)	MMP (MPa)	MMP reduction	Error	R ²	95% LCL	95% UCL	Cloud point pressure (MPa)
Base case	-	29.30	-	±0.737	0.986	27.636	30.971	-
ME-1	2.50%	28.74	1.9%	±1.010	0.981	26.265	31.208	29
ME-6	5%	26.65	9.0%	±0.601	0.993	24.979	28.317	26.9
ISOFOL-16	5%	28.99	1.1%	±0.711	0.989	27.309	30.673	30.6
Marlipal O13	3%	28.45	2.9%	±1.449	0.966	24.722	32.170	31.7

4.3.3 Effect of Temperature on Chemical Performance in Reducing MMP

The IFT experiments were repeated at a lower temperature (333 K) using surfactant based chemicals to investigate the effect of temperature on the MMP reduction in methane-oil system, the results indicate better chemical performance at higher temperature (373 K), suggesting that chemical-assisted MMP reduction would favour high temperature reservoirs.

For example, we observed a limited or no effect on the MMP reduction at 333 K for the tested chemicals, where the effect was much more obvious when the experiment was performed at higher temperature. In particular the IFT reduction using SOLOTERRA ME-6 at 333 K was 7% compared to 9% at 373 K, as the MMP decreased from 27 to 25.13 MPa. Similarly, there is a limited IFT reduction observed in the CH₄-oil system at 333 K using surfactant-based chemical (SOLOTERRA ME-1) as the MMP decreased only 1% (from 27 to 26.73 MPa). The higher MMP reduction could be due to improved chemical solubility at higher temperatures which leads to better miscibility between gas and oil phases.

Furthermore, the miscibility is improved between methane and oil at lower temperature,

thereby there is less potential for the chemical to further improve the miscibility at low temperature. This result suggests that high temperature reservoirs will benefit the most from adding chemical solvents to methane injection, whilst the performance of chemicals is improved and the MMP value does not change much with the increased temperature.

Table 4.4 Summary of IFT experimental results in methane-oil system at 333 K

Chemical	Concentration (wt. %)	MMP	MMP reduction	Error	R2	95% LCL	95% UCL
Base case	-	27.01	-	± 0.809	0.986	25.025	28.985
ME-1	2.50%	26.73	1.0%	± 0.796	0.988	24.677	28.771
ME-6	5%	25.13	7.0%	± 0.488	0.995	23.873	26.383

4.4. Proposed Mechanism from Surface Chemistry Perspective

We tested two different types of chemical additives (surfactant and alcohol based) and explored the potential chemical-assisted interfacial tension reduction in methane-oil systems through vanishing interfacial tension measurements. While our results show that both type of chemicals do not achieve substantial MMP reduction for methane-oil systems, our work sheds light on the significance of chemical type in particular surfactants and alcohols on the MMP reduction of methane-oil systems. We also propose two plausible mechanisms to account for the chemical-assisted MMP reduction for methane-oil and CO₂-oil systems.

First, the adsorption of the added chemical molecules into the gas-oil interface, where the polar function head group interacts with the gas phase and the hydrocarbon chain interacts with the oil phase, where methane with slightly positive hydrogen atoms interacts with slightly negative oxygen atoms in the chemical's head group (propylene oxide, ethylene oxide or hydroxyl) through hydrogen bonding, and thus enhances the extraction of light crude oil components and assists in achieving multi contact miscibility. This mechanism is highly

dependent on the type of the used chemical, oil composition and gas composition. Figure 4.3 shows a schematic diagram to explain the development of methane-chemical-oil interactions.

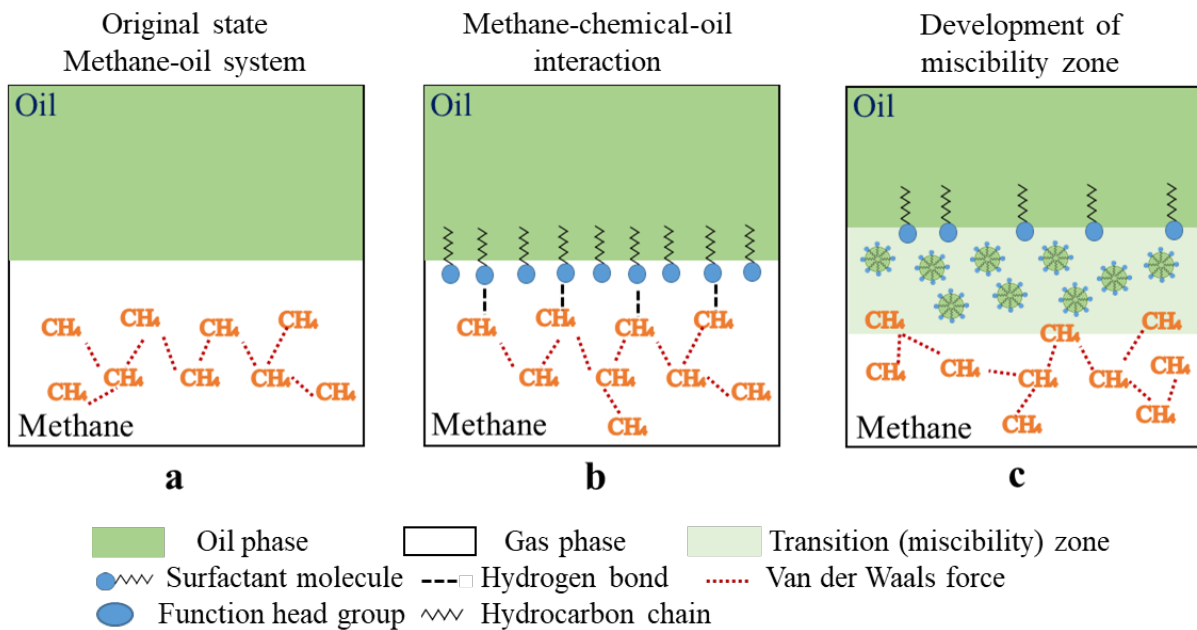

Figure 4.3 Schematic diagram of methane-chemical-oil interaction

- Original state (Van der Waals forces between methane molecules)
- Chemical adsorbed into to gas oil interface (methane with positively charged hydrogen atoms interacts with negatively charged oxygen in the chemical's head group through hydrogen bonding, where hydrocarbon chain attaches to crude oil)
- Light crude oil components are extracted into gas phase and miscibility zone is formed

Second, vaporisation and condensation processes that are developed through gas and oil phases, where light oil components vaporise into the gas phase, then the gas phase becomes enriched and start to condense into oil phase resulting in a transition zone where the gas and oil phases are mixed, and thus achieve the multi contact miscibility. The second mechanism strongly depends on the associated pressure and temperature conditions, whereas the addition of chemical solvents could facilitate the development of the transition zone and help to achieve the miscibility at lower pressure. The degree of the contribution of each of the two

mechanisms in the MMP reduction could be further investigated by analysing the effluent gas of the coreflooding or slim tube experiments.

The main difference between the interaction of surfactant and alcohol based chemicals with the gas-oil system is the type of polar functional head group which controls the gas extraction capacity. In addition to the length of the hydrocarbon chain which governs the interaction with the oil phase. In the case of the tested alkoxyated surfactants, the miscibility is improved compared to alcohol due to the presence of the larger lipophilic headgroups (ethoxylated and propoxylated) which enlarges the miscibility (transition) zone having more capacity to extract lighter hydrocarbons into gas and at the same time also provide a higher amount of enriched gas which is able to condense into the oil phase, thereby effectively eliminate the interfacial tension and improves the miscibility process.

However, in the case of the tested alcohol based chemicals, where the only functional headgroup is the hydroxyl group, there is a limited interaction between chemical and the gas phase (methane), resulting in a minor effect for the alcohol additives in improving the miscibility. Figure 4.4 shows the different functional groups used in these experiments.

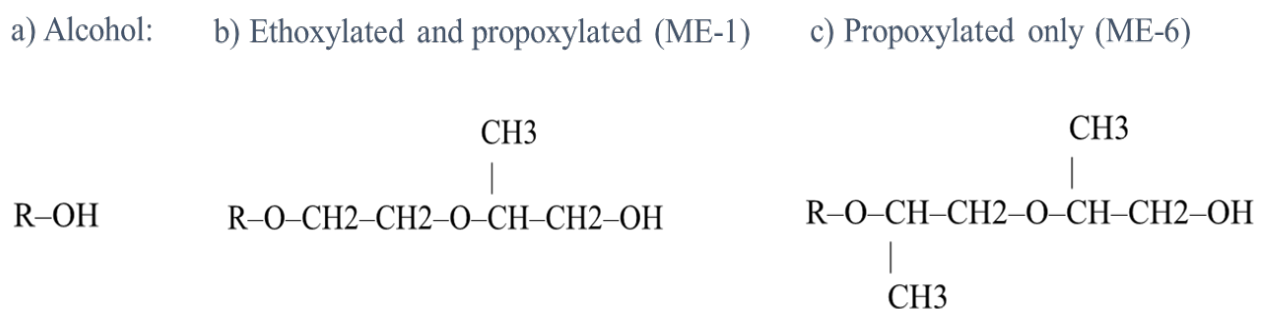

Figure 4.4 Sketch of the tested functional groups. a) alcohol based chemical with hydroxyl group, b) surfactant based chemical with ethoxylated and propoxylated groups, and c) surfactant based chemical with propoxylated group.

4.5. Conclusions and Implications

In this work, we investigated the potential of chemical assisted MMP reduction in methane-oil system in order to enable miscible natural gas injection in high temperature reservoirs. First, we examined the effect of pressure and temperature on the equilibrium IFT values of the methane-oil system using VIT method. Then, we tested the effect of four different chemical additives (surfactant and alcohol based chemicals) on reducing the minimum miscibility pressure. The results show a promising MMP reduction of 9% using 5 wt. % of the surfactant based chemical (SOLOTERRA ME-6) at 373 K. However, the tested alcohol-based chemicals resulted in a limited MMP reduction, possibly due to the lack of polar functional head group (only hydroxyl group) and thereby limited interaction with gas phase. Furthermore, we compared our results with similar experiments on CO₂-oil system showing lower miscibility pressure and higher MMP reduction using CO₂ due to its higher extraction capability compared to methane. However, the application of CO₂ injection is not always possible due to the limited availability of pure CO₂ sources in some locations and the significant decrease of its solvation power with increasing temperature, therefore, re-injection of produced natural gas is considered a feasible option due to the benefits of increasing recovery factor and reducing associated gas flaring. In this context, our work likely expands the application envelop of the miscible natural gas injection to deep reservoirs associated with high pressure and high temperature by adding chemicals to reduce the MMP, in which improves the economics by achieving a higher recovery factor at the same injection pressure. However, further work is recommended to optimise chemical type and concentration to develop more economically feasible injection.

Chapter 5 Effect of Functional Groups on Chemical-Assisted MMP

Reduction of a Methane-Oil System*

Abstract

Natural gas injection (i.e., recycling) is a commonly used for enhanced oil recovery method and is potentially cost-effective and efficient. However, natural gas injection, particularly methane, often has a high minimum miscibility pressure (MMP) which likely exceeds the fracture pressure of many otherwise viable reservoirs. Therefore, this work aims to investigate the potential of chemical-assisted MMP reduction of the methane-oil system to expand the application of miscible natural gas injection to more candidate reservoirs. In this context, we performed a study to test six potential surfactant-like chemicals with different polar head groups (i.e., morpholine, aromatic sulfonic acid, aromatic carboxylic acid and 2-oxopyrrolidine). The intent is to reduce the methane-oil interfacial tension (IFT) using the vanishing interfacial tension method (VIT) at a constant temperature of 373 K. First, at a concentration of 2 wt.%, we tested the effect of the polar head groups with the same hydrocarbon chain. Then, we investigated the effect of increasing the hydrocarbon chain length of the most effective head groups on the methane-oil miscibility.

Our results show that chemical additives with the 2-oxopyrrolidine and aromatic sulfonic acid functional groups give higher MMP reductions (8.7 to 9.6%, respectively) compared with aromatic carboxylic acid and morpholine groups, which only give limited or no MMP reduction. Moreover, the results show that the reduction in first contact miscibility (FCM) pressure is higher (12.8 to 19.1%) compared to MMP reduction, which could be more beneficial for gas injection in deep and high-pressure reservoirs. Furthermore, increasing the

* Reference: Almobarak, M., et al., *Effect of Functional Groups on Chemical-Assisted MMP Reduction of a Methane-Oil System. Energy & Fuels*, 2021. 35(18): p. 14519-14526

hydrocarbon chain length (from 10 to 13) of the 2-oxopyrrolidine and aromatic sulfonic acid molecules seems to decrease the efficiency in reducing MMP. Our results screen the potential of a combinatorial chemistry approach (where two molecules with differing size and functional groups can be readily joined together to make a large library of compounds) can be used to identify chemical additives for reducing MMP of methane-oil. This approach underscores the importance of optimising the functional group and hydrocarbon chain length in potential chemicals for MMP reduction. The outlined research results likely expand the application of miscible natural gas injection to deep and/or high-temperature reservoirs, in addition to the environmental benefits of reducing gas flaring and greenhouse gas emissions through natural gas recycling.

5.1. Introduction

Despite significant interest in renewable energy technologies, hydrocarbon resources remain essential for meeting increasing global demand in both energy and chemical sectors [2-4, 114]. Generally, primary and secondary recovery methods are able to produce up to one third of the original oil in place (OOIP) [5] with approximately two thirds of the OOIP remaining in reservoirs. Therefore, using enhanced oil recovery (EOR) techniques in the tertiary recovery stage is considered essential to further unlock the remaining significant amount of hydrocarbon resources in place. In this context, gas flooding has been identified as an efficient, cost-effective and potentially environmentally friendly method to increase oil recovery. Typically, associated gas re-injection yields an incremental oil recovery ranging from 10 to 25% of OOIP [93-95]. In particular, miscible gas injection has gained interest in the petroleum industry due to its lower residual oil saturation and higher oil relative permeability compared to immiscible gas injection [21-23, 25, 96].

Miscibility between the gas and oil phases is achieved when the interfacial tension (IFT) between the two immiscible phases is reduced to zero. The improvement in oil recovery by

miscible gas injection process is explained by a likely combination of several mechanisms such as reduced oil viscosity, oil swelling and decreased IFT [16-19]. Typically, miscibility is achieved in the reservoir in several stages through multi-contact miscibility processes. These processes are typically divided into condensing gas drive and vaporising gas drive [28, 35], where the gas phase is enriched through the extraction (vaporisation) of light and intermediate crude oil components and then the enriched gas is dissolved (condensed) into the oil phase. Consequently, a miscibility (transition) zone is formed between the gas and oil phases [29, 30].

However, the minimum miscibility pressure for some reservoirs is far higher than the formation fracture pressure, which limits the application of miscible gas injection and this inability to achieve miscibility results in unfavourable sweep efficiency. This problem typically occurs in high temperature reservoirs where the MMP increases due to the high temperature, or in shallow reservoirs where the fracture pressure is very low. Therefore, CO₂ is the most widely used gas in miscible gas injection projects due to its comparatively low miscibility pressure with crude oil. However, natural CO₂ resources are not commonly available for injection in hydrocarbon reservoirs and alternative sources of CO₂ can be prohibitively expensive. Consequently, re-injection of associated natural gas into an oil reservoir appears to be an effective method due to its low cost and availability. Therefore, there is a rationale for exploring the feasibility of MMP reduction using chemical additives in a methane-oil system.

In this context, a chemical-assisted MMP reduction approach for the methane-oil system which changes the gas injection process from immiscible to miscible and consequently increases the oil recovery factor by up to 10% [21-23, 25, 96] can be attractive. There are several literature reports on chemical additives for MMP reduction of the CO₂-oil system with laboratory results showing a promising MMP reduction of up to 22% using chemical

additives at concentrations between 0.1 and 5 wt.%. For example, using the vanishing interfacial tension (VIT) method, Luo et al [70] investigated the effect of non-ionic surfactants on interfacial tension and MMP reduction in a CO₂-oil system. They reported that the addition of 0.6 wt. % of propoxylated surfactants in CO₂ yields a reduction in MMP from 19.1 to 13.8 MPa. Similarly, Guo et al. [68] examined the effect of a synthesised surfactant (CAE) on the MMP reduction using a slim tube method at constant temperature of 358 K and a pressure range of 18-30 MPa. They reported MMP reduction of 6.1 MPa (a reduction of 22%) using 0.2 wt. % as a pre-slug before gas injection in the slim tube experiment. However, to date there is distinct lack of research regarding similar approaches for MMP reduction in natural gas-oil systems. This is particularly evident in the methane-oil system which typically has a higher initial MMP compared to other gases. Previously, we have showed that surfactant molecules based on alkoxyated alcohols could reduce the MMP by up to 9 % for a methane-crude oil system at 373 K [115].

Given the huge increase in natural gas production from unconventional resources over recent decades, the ability to utilise the produced associated natural gas for EOR could have a great benefit. Therefore, this research aims to identify potential chemical additives for MMP reduction thus enabling miscible natural gas injection for EOR applications. In this context, we hypothesise that adding a chemical with a polar head group and lipophilic hydrocarbon tail could improve the miscibility conditions and reduce the MMP in the methane-oil system. In order to test our hypothesis, we performed a systematic study by measuring the equilibrium IFT in the methane-oil system at a constant temperature (373 K) and different pressures ranging from 6 to 38 MPa to estimate the MMP and FCM pressures. In this study, we extend our previous work and use a small library of compounds based on a range of polar head groups (i.e., morpholine, aromatic sulfonic acid, aromatic carboxylic acid and 2-oxypyrrolidine) attached to hydrophobic tails (long-chain alkyl carboxylic acids) that are

joined by an amide bond. Furthermore, we increased the hydrocarbon chain length with the most effective head groups (i.e. aromatic sulfonic acid and 2-oxypyrrolidine) to investigate the effect on MMP. In all these experiments, the MMP was estimated using the vanishing interfacial tension (VIT) method.

5.2. Experimental and Procedures

5.2.1. Material

The crude oil sample used for this study was collected from a wellhead in a high-temperature reservoir (413 K) in Western China. The reservoir oil has a base number of 1.3 mg KOH/g and an acid number of 3.98 mg KOH/g. The measured oil density, viscosity and freezing point is 0.85 g/cm³, 5.23 mPa.s and -20 °C (standard conditions), respectively. The polar components in the crude oil included wax (3.58 wt %) and asphaltene (0.54 wt %).

Methane (99.99 mol % purity, supplied by Coregas, Australia) was used to mimic the gas phase under field conditions. However, in actual oil reservoirs, the gas is rarely pure and the presence of some impurities in the gas stream certainly affects the miscibility pressure with oil. For example, the presence of gases like CO₂, ethane or propane will enrich the methane and reduce the miscibility pressure [53, 92, 102]. In other words, pure methane injection could be considered as the worst-case scenario for gas injection in terms of miscibility pressure (i.e., requiring the highest pressure to achieve miscibility).

Six different chemical additives with four different functional head groups (i.e., morpholine (Figure 5.1 (c)), aromatic sulfonic acid (Figure 5.1 (b) & (e)), aromatic carboxylic acid (Figure 5.1 (f)) and 2-oxypyrrolidine (Figure 5.1 (a) & (d)) and two different hydrocarbon chain lengths (i.e. C₁₀ and C₁₃) linked by an amide bond were studied. The surfactant-like chemicals were synthesized by N,N'-carbodiimazole coupling of carboxylic acids and amines, following procedures as outlined in WO2018218281 [116]. A typical reaction

scheme and their corresponding nuclear magnetic resonance (NMR) spectra to confirm their chemical structures are given in the supporting information. These molecules were selected from a larger library of compounds that were synthesized by combining different amine-containing end groups and various long-chain alkyl carboxylic acids to form an amide linkage. In this work, a chemical concentration of 2 wt. % in the oil phase at 373 K has been used in all experiments and we have detailed the rationale for this approach previously [115].

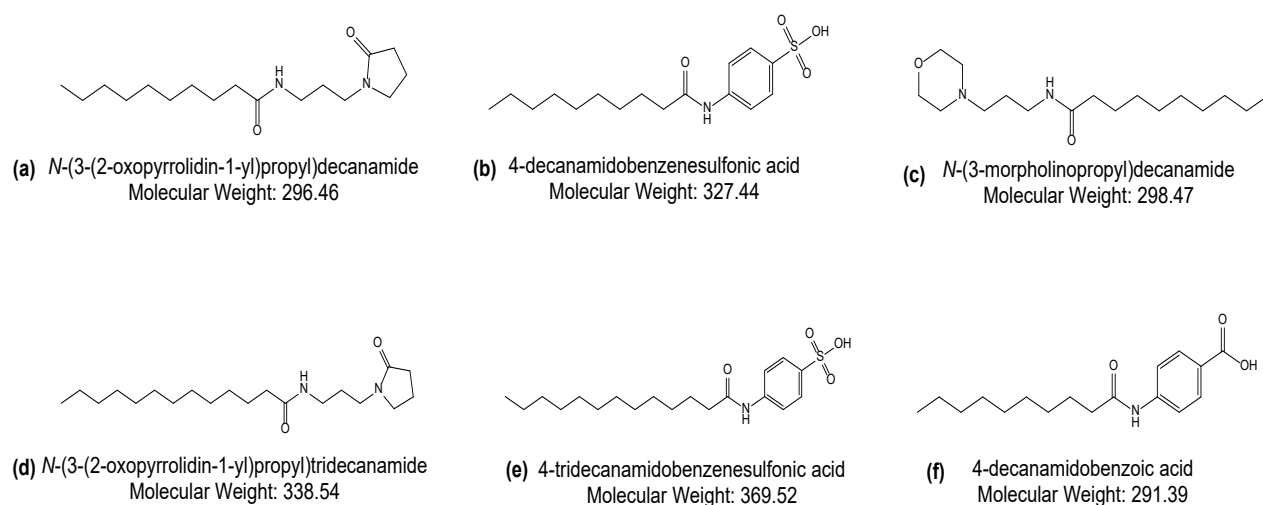

Figure 5.1 Structure of the six chemical additives used in this study

5.2.2. Procedures of Interfacial Tension Measurements

In this work, the minimum miscibility pressure (MMP) of the gas-oil system was determined using the vanishing interfacial tension (VIT) technique which is a well validated approach for measuring the MMP within this context and is an attractive alternative to the traditional slim tube technique due to its relative simplicity [46, 52, 54, 55, 58, 103]. In this method, the equilibrium IFT (y-axis) between the gas and crude oil is measured at a range of pressure points (x-axis) at constant temperature; subsequently, using linear regression the data is extrapolated to zero and the x-axis intercept represented the MMP value for multi-contact miscibility [60] which is based on the concept that miscibility is achieved when the IFT is between two different phases reaches zero. The IFT measurements in the gas-oil system were

conducted at a pressure range between 4 and 35 MPa at a constant temperature (373 K) using the IFT700 equipment (Vinci-Technologies). Figure 5.2 shows a schematic diagram of the experimental apparatus used in this study. The IFT values were calculated using the axisymmetric drop shape analysis (ADSA) technique through the pendant drop method [19, 56]. The same procedures used in a prior study were also used for this study [115].

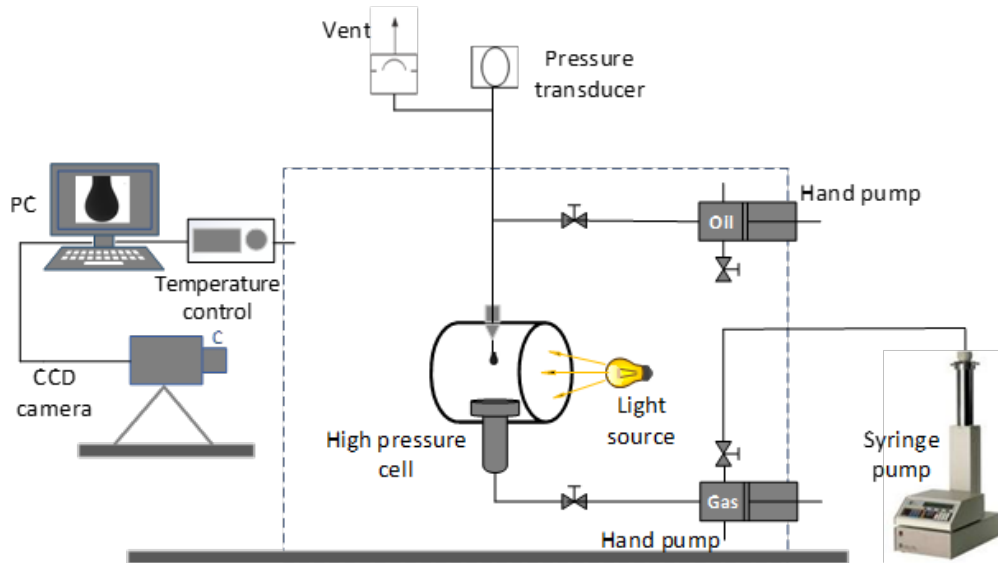

Figure 5.2 Schematic diagram for interfacial tension (IFT) measurements at HT-HP

5.3. Results and Discussion

5.3.1. Effect of Pressure on Miscibility of Methane-Oil System

First, we measured the IFT between methane and oil without any chemical additives to serve as the base case for MMP and FCM reduction evaluation for the chemical additives are used. Typically, as the pressure increases the interfacial tension between the two immiscible phases (gas and oil) decreases until reaching the miscibility at zero interfacial tension. In this experiment, the minimum miscibility pressure (MMP) and first contact miscibility pressure (FCM) of the methane-oil system were measured at a constant temperature (373 K). As shown in Figure 5.3, the IFT decreases with increasing pressure with two different trends. In the first region, the IFT is linearly extrapolated to estimate the minimum miscibility pressure

(MMP), whilst the extrapolation of the IFT in the second region estimates the first contact miscibility (FCM) pressure [52]. In this experiment, the MMP and FCM of methane-oil system were estimated to be 31.7 MPa and 64.8 MPa respectively. This experiment serves as the base case to evaluate the MMP reduction in the subsequent experiments when the chemical additives are used.

The IFT trend with increasing pressure can be explained by two main factors. First, increasing pressure increases the intermolecular forces of the gas molecules, which results in increasing its density and thus promotes miscibility [31, 110, 111]. Second, increasing pressure likely improves the extraction of crude oil components into gas phase and the condensation of enriched gas into crude oil [19, 29, 32, 69, 108]. These processes of extraction (vaporisation) and condensation between gas and oil phases are developed through several stages (multi-contact miscibility). For example, the light and intermediate crude oil components are extracted first into the gas phase (the first IFT trend), then with further increasing pressure (the second region), the heavier oil components start to be extracted into the gas phase at a slower rate [31, 108, 117].

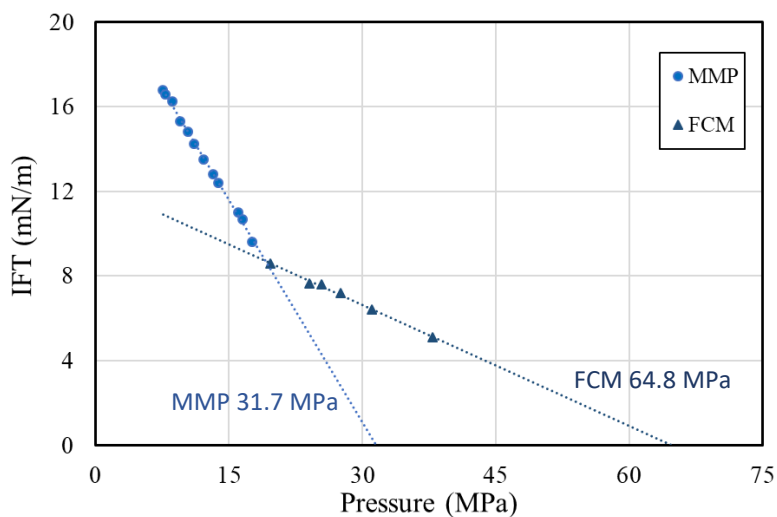

Figure 5.3 IFT of pure CH₄-crude oil system at 373 K with no additives

5.3.2. Effect of Functional Head Groups on MMP

To investigate the effect of the different functional head groups (i.e., morpholine, aromatic sulfonic acid, aromatic carboxylic acid and 2-oxopyrrolidine) on the methane-oil system, we have tested four chemical additives (i.e. compounds (a), (b), (c) and (f), Figure 5.1) with different head groups at the same concentration (2 wt.%) and the same hydrocarbon chain length (C_{10}). In other words, the only variable in the following experiments of gas-chemical-oil interaction is the functional head group of the tested chemical. As shown in Figure 5.4, the addition of chemical (a) (Figure 5.1) (containing the 2-oxopyrrolidine group) into the methane-oil system results in decreasing interfacial tension between methane and crude oil at all pressure points. For instance, the estimated MMP decreased from 31.7 to 28.65 MPa (9.6% MMP reduction compared to the base case), while the FCM pressure further decreased from 64.8 to 56.5 MPa (12.8% reduction compared to the base case).

Typically, the nitrogen-bearing compounds can react with the acidic components in the crude oil [118]. Therefore, the improved miscibility using the additive (a) (Figure 5.1) may be attributed to the hydrogen bonding of the amide moiety with the acid-base components in the crude oil at the methane-oil interface. In particular, the pyrodine.

The improved miscibility using the additive (a) (Figure 5.1) may be attributed to the hydrogen bonding of the amide moiety with the acid-base components in the crude oil at the methane-oil interface. In this arrangement, the formed hydrogen bonding improves methane extraction by the hydrocarbon tail and assists in reducing the IFT between the gas and oil phases, and thus improves the miscibility and reduces the MMP. However, there are several factors to be considered in gas-chemical-oil interaction, like the effect of hydrogen bonding density, strength of the hydrogen bonding and hydrocarbon chain length. Further increasing the pressure after reaching the MMP improves the strength of the hydrogen bonding (at a constant temperature), in addition to increasing the density of the methane gas, which reduces

the interfacial tension between the gas and oil phases and assists in enhancing the miscibility. Therefore, the FCM reduction is higher compared to the MMP reduction due to the combined effect of chemical-gas-oil interaction and the improved miscibility at higher pressures. This could be particularly beneficial for deep and high-pressure reservoirs, where the addition of a small amount of chemical could result in a significant miscibility enhancement.

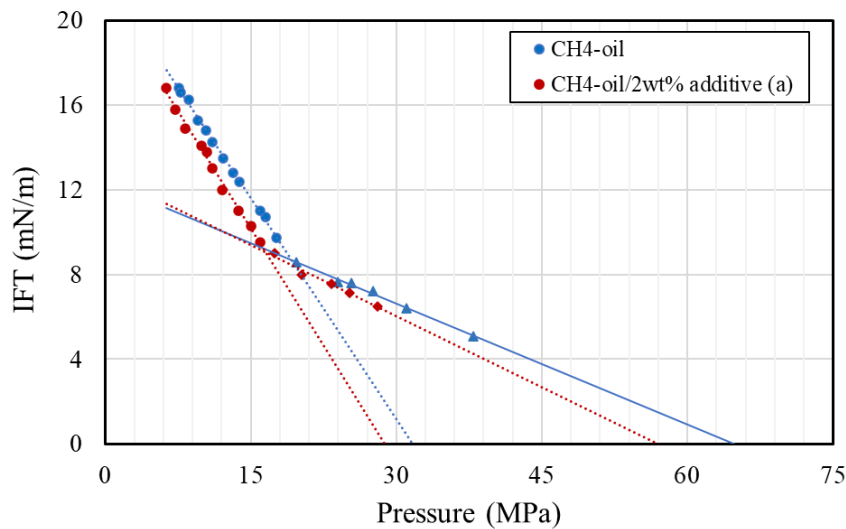

Figure 5.4 IFT of CH₄-oil at 373 K for 2 wt.% additive (a) (containing 2-oxopyrrolidine group)

In the second experiment, we tested the IFT reduction of methane-oil system using additive (b) (Figure 5.1) which contains an aromatic sulfonic acid as the head group and decane as a hydrocarbon tail. Similar to the previous example with the oxopyrrolidine head group, additive (b) shows a positive impact on improving methane-oil miscibility at different pressures, as shown in Figure 5.5. For example, the MMP decreased from 31.7 to 28.95 MPa (8.7% reduction), whereas the FCM pressure reduction was much higher, as it decreased from 64.8 to 52.4 MPa (19.1% reduction).

A similar mechanism of chemical adsorption into gas-oil interface is expected to occur due to the polar nature of the aromatic sulfonic acid head group. As a result of the chemical-gas-oil interaction at the interface, the sulfonic acid head group forms hydrogen bonding with the acid-base components within the crude. In addition, the location of the sulfonic acid group in

the para position of the benzene ring and the relatively strong acidity of the aromatic sulfonic acid groups gives more stability and strength to the hydrogen bonding. Therefore, the results suggest that the high hydrogen bonding density and strength plays a major role in reducing the IFT. A similar observation in the oil-brine system was reported by Li et al, as they reported based on molecular dynamics simulation that the hydrogen bonding density is inversely proportional to the IFT of the oil-brine system [119].

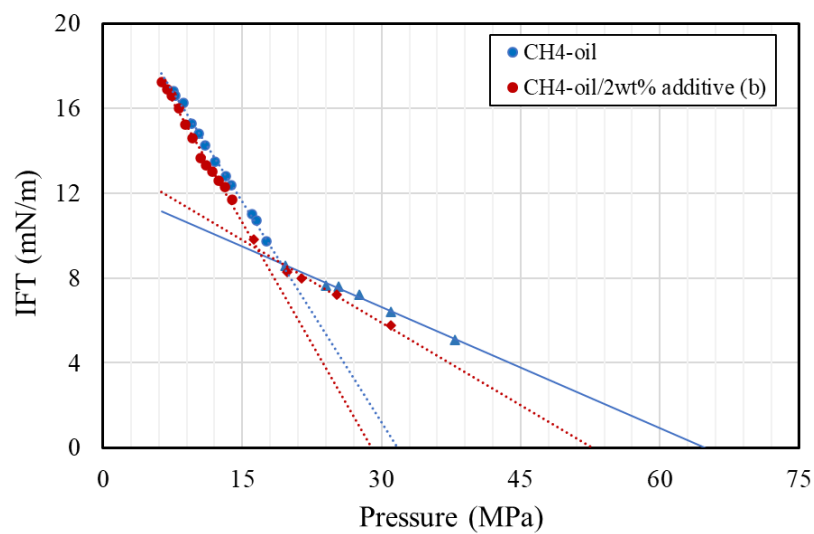

Figure 5.5 IFT of CH₄-oil at 373 K for 2 wt.% additive (b) (containing aromatic sulfonic acid group)

In the next experiment, we tested the effect of the substituents (COOH instead of SO₃H) on the carboxylic acid group in additive (f) on the IFT reduction of methane-oil system, where the benzoic acid was used as a functional head group and decane as a hydrocarbon tail. As shown in Figure 5.6, the results suggest a limited IFT reduction in the methane-oil system at 373 K compared to the oxopyrrolidine and benzenesulfonic acid head groups. For example, the MMP decreased from 31.7 to 31.3 MPa (1.3% reduction). The minor effect on the miscibility could be due to the weaker acidity of the benzoic acid compared to benzenesulfonic acid. Therefore, the results suggest that the polarity of the functional head

group and hydrogen bonding density and strength are the major controlling factors in the miscibility process.

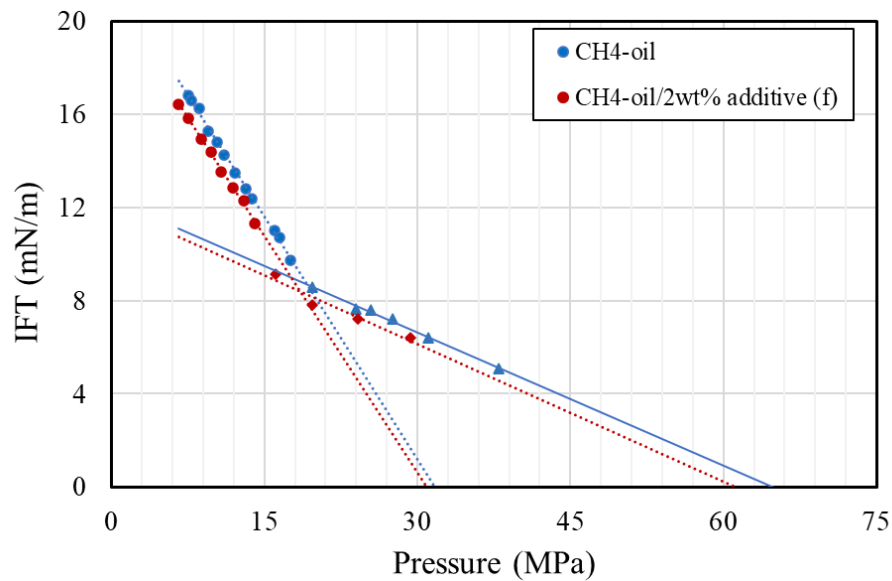

Figure 5.6 IFT of CH₄-oil at 373 K for 2 wt.% additive (f) (containing aromatic carboxylic acid group)

In contrast, additive (c) (Figure 5.1) which contains a morpholine head group did not show any measurable IFT reduction in the methane-oil system. As shown in Figure 5.7, the equilibrium IFT values of additive (c) are almost the same as the base case without any additives. The results suggest that the hydrogen bonding characteristics of the morpholine (the oxygen and nitrogen atoms are further apart relative to additive (a)) have limited its ability to interact at the methane-oil interface and thus it is not effective at reducing MMP for this system.

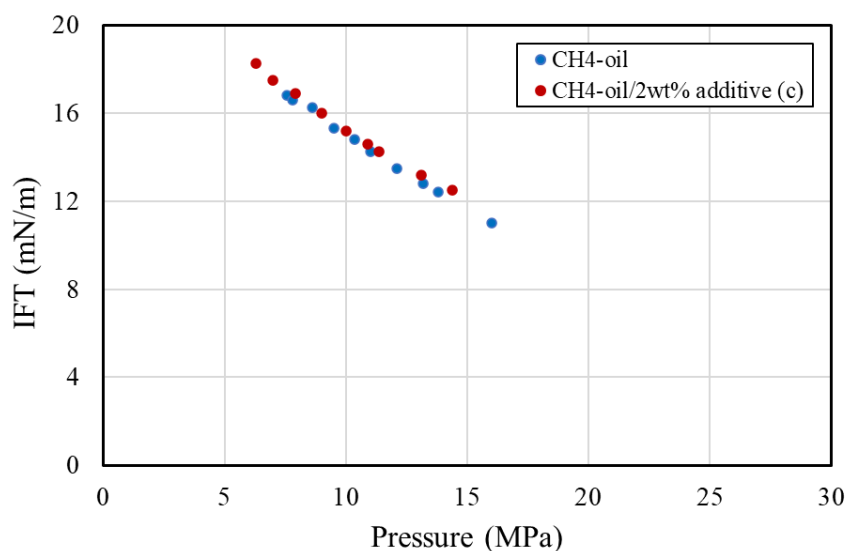

Figure 5.7 IFT of CH₄-oil at 373 K for 2 wt.% additive (c) (containing morpholine group)

From the preliminary study of the effect of different head groups on MMP, additive (a) and (b) demonstrated to be promising candidates in reducing the miscibility pressure in the methane-oil system. In particular, the results suggest that amide groups with strong hydrogen bonding characteristics and strongly acidic groups have more affinity to interact at the methane-oil interface to reduce the IFT. Furthermore, the results highlight the role of hydrogen bonding density and strength in reducing the interfacial tension between methane and crude oil, and thus reducing the MMP and FCM. However, the reduction of FCM pressure were much higher compared to MMP, which could be more beneficial for deep and high-pressure reservoirs.

5.3.3. Effect of Hydrocarbon Chain Length

To further investigate the controlling factors of the chemical-assisted MMP reduction process, we have tested the effect of increasing the hydrocarbon chain length of the most effective chemicals (i.e. additives (a) and (b)) on the interfacial tension between methane and oil at 373K. Specifically, we increased the hydrocarbon chain length from ten (decanamide, C₁₀H₂₁NO) to thirteen (tridecanamide, C₁₃H₂₇NO). As shown in Figures 5.8 and 5.9, the results show that increasing hydrocarbon chain length reduces the performance of the

chemical additives. For example, the MMP reduction using a C13 tail with the 2-oxopyrrolidine head group is only 3.9% (additive (d), Figure 5.1) compared with 9.6% (additive (a)) containing a shorter hydrocarbon chain. Similarly, the MMP reduction of the aromatic sulfonic acid bearing chemical is only 1.1% (additive (e)) using the longer hydrocarbon chain compared to 8.7% (additive (b)) using the shorter chain. Therefore, based on the limited effect of the long hydrocarbon chain additives (d) and (e) on the MMP reduction, the FCM were not measured for these chemicals as it will not be feasible/practical in this case.

The results highlight the significant effect of the hydrocarbon chain length on the chemical performance, where the reduced miscibility using the longer hydrocarbon chain could be explained by poor interactions between the hydrocarbon tail and the crude oil. It is probable that the longer chain might self-coil and not fully stretch towards the crude oil [74], hence the contact area between the chemical and oil is reduced. It is likely that the shorter chains attach to the short and intermediate components of the crude oil to facilitate the extraction by the gas, whereas the longer hydrocarbon chains attach to the heavier crude oil components, which could make it harder for extraction by methane gas due to its low solvation power (limited extraction ability).

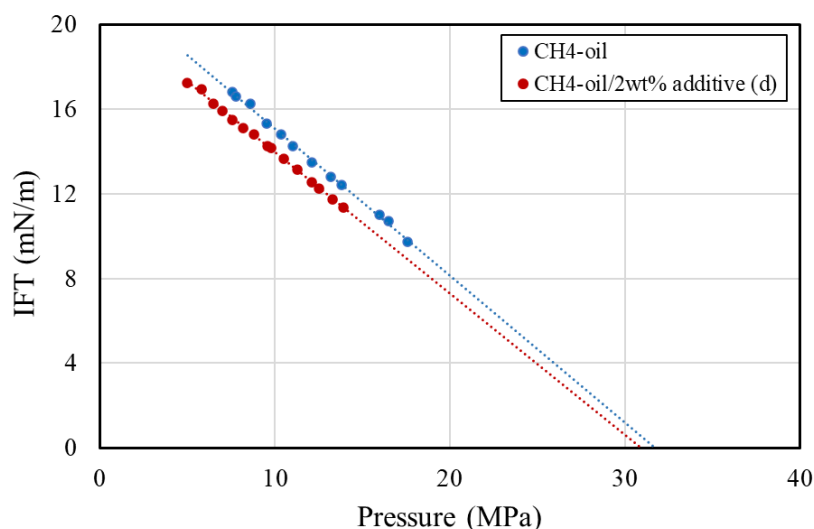

Figure 5.8 IFT of CH₄-oil at 373 K for 2 wt.% additive (d) (containing 2-oxopyrrolidine group, longer hydrocarbon chain)

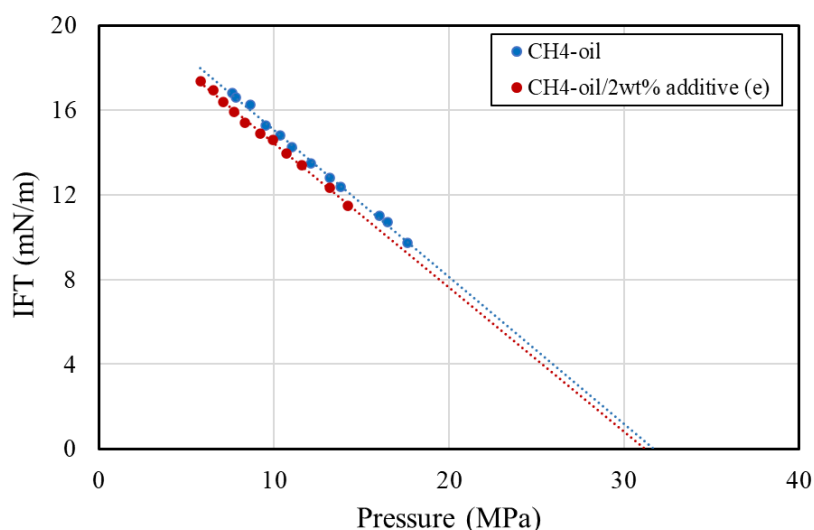

Figure 5.9 IFT of CH₄-oil at 373 K for 2 wt.% additive (e) (containing aromatic sulfonic acid group, longer hydrocarbon chain)

Based on the experimental results, chemical-assisted MMP reduction appears to be a promising method to improve the miscibility between methane and oil. However, there are several controlling factors for the miscibility process. Therefore, optimising chemical composition and concentration is essential to design a feasible and successful miscible gas injection project. Table 5.1 summarises the experimental results of methane-oil IFT at 373 K using different chemicals of this study.

Table 5.1 Summary of IFT experimental results in methane-oil system at 373 K

Chemical	MMP (MPa)	MMP reduction	FCM (MPa)	FCM reduction	Comments
Base case	31.70	-	64.80	-	No chemical
Additive (a)	28.65	9.6%	56.50	12.8%	Strong hydrogen bonding acceptor characteristics
Additive (b)	28.95	8.7%	52.40	19.1%	Strong acidic characteristics
Additive (f)	31.30	1.3%	-	-	
Additive (c)	31.70	0.0%	-	-	
Additive (d)	30.47	3.9%	-	-	Long hydrocarbon chain relative to (a)
Additive (e)	31.36	1.1%	-	-	Long hydrocarbon chain relative to (b)

5.3.4. Proposed Mechanisms

In this work, we performed a systematic study to evaluate the potential of some chemical additives to reduce the miscibility pressure in the methane-oil system. In particular, we

investigated the effect of the functional head group and hydrocarbon chain length of the additives on the MMP and FCM. Our results show that the presence of polar components in the head group and optimising the hydrocarbon chain length of the chemical additives could significantly improve the miscibility between the two phases (methane and oil) at the same pressure and temperature conditions, thus reduce the MMP and FCM pressure. Based on the experimental results, we discuss the main controlling factors to design an effective chemical to improve methane-oil miscibility.

First, the functional head group of the additives plays a major role in the miscibility mechanism, as the polarity of the head group assists the additives to be adsorbed at the gas-oil interface. The chemical-methane interaction is influenced by the ability of the head group to form hydrogen bonding with the methane. Either strong acid groups or functional groups that have strong hydrogen bonding acceptor characteristics (i.e., amides) appear to be viable approaches for reducing MMP. The ability to reduce MMP through these mechanisms is also likely to be dependent on the acid and base characteristics of the crude oil.

Second, the hydrocarbon chain length of the chemical is a main factor in reducing methane-oil interfacial tension, as it determines the chemical-oil interaction. Chemicals with short non-polar hydrocarbon chains will likely be attached to similar (short and intermediate) crude oil components, where the chemicals with longer chains will be likely attached to heavier crude oil components. Therefore, increasing the hydrocarbon chain length could be beneficial up to a certain limit only due to increasing the contact area between the chemical and crude oil. Afterwards, further increases of the chain length reduces the miscibility, as the solvation ability of the methane phase is weak. It is worth noting that this mechanism is highly dependent on the crude oil composition as well.

Beside the chemical-gas-oil interaction, factors like pressure and temperature of the system have a significant impact on the miscibility. For example, an increase in temperature of the system (at a constant pressure) reduces the gas density and weakens the hydrogen bonding between the additive and gas, and thus reduces the gas-oil miscibility. In contrast, increasing pressure (at a constant temperature) increases the density and intermolecular forces of the gas phase, resulting in reducing gas-oil interfacial tension and enhancing miscibility. It worth noting that, the presence of gas impurities in the methane would further add complexity to the chemical-gas-oil interactions and results in a different miscibility pressure. Therefore, understanding the mechanism of chemical-gas-oil interactions is essential to design the effective chemical to improve gas-oil miscibility and to reduce the miscibility pressure, and consequently increase oil recovery factor.

5.4. Conclusion and Implications

In this work, we investigated the effect of the functional head group and hydrocarbon chain length on the miscibility of the methane-oil system using six different additives. First, we measured the interfacial tension and estimated the minimum miscibility pressure using four different functional head groups and the same hydrocarbon chain (decanamide) using VIT method, then we further investigated the effect of increasing the hydrocarbon chain length (from decanamide to tridecanamide) for the most effective chemicals. The experimental results indicate that polar functional groups are more effective in improving the methane-oil miscibility. For example, adding 2% of the additives containing 2-oxopyrrolidine and aromatic sulfonic acid head groups into the methane-oil system results in reducing the MMP by 9.6% and 8.7%, respectively; whereas, the aromatic carboxylic and morpholine bearing groups did not improve the miscibility due to weaker interactions with the crude oil. Furthermore, the results indicate the importance of optimising the hydrocarbon chain length of the additives, where the shorter chain length resulted in better miscibility. For instance,

using the 2-oxopyrrolidine, the achieved MMP reduction was 3.9% using the longer chain compared to 9.6% using the shorter chain.

Our results highlight the potential of chemical additives to reduce the miscibility pressure of methane-oil system, in addition to providing outlines for the screening criteria of the potential effective chemical additives. Furthermore, the outlined results likely expand the application of miscible natural gas injection to deep and high-temperature reservoirs, in addition to the environmental benefits of reducing gas flaring and greenhouse gas emissions through natural gas recycling.

Chapter 6 Chemical-Assisted MMP Reduction on Methane-Oil Systems: Implications for Natural Gas Injection to Enhanced Oil Recovery*

Abstract

Miscible natural gas injection is widely considered as a practical and efficient enhanced oil recovery technique. However, the main challenge in this process is the high minimum miscibility pressure (MMP) between natural gas and crude oil, which limits its application and recovery factor, especially in high-temperature reservoirs. Therefore, we present a novel investigation to quantify the effect of chemical-assisted MMP reduction on the oil recovery factor. Firstly, we measured the interfacial tension (IFT) of the methane-oil system in the presence of chemical or CO₂ to calculate the MMP reduction at a constant temperature (373 K) using the vanishing interfacial tension (VIT) method. Afterwards, we performed three

* Almobarak, M., et al., *Chemical-Assisted MMP Reduction on Methane-Oil Systems: Implications for Natural Gas Injection to Enhanced Oil Recovery*. *Petroleum*, 2022.

coreflooding experiments to quantify the effect of MMP reduction on the oil recovery factor under different injection scenarios.

The interfacial tension measurements show that adding a small fraction (1.5 wt.%) of the tested surfactant (SOLOTERRA ME-6) achieved 9% of MMP reduction, while adding 20 wt.% of CO₂ to the methane yields 13% of MMP reduction. Then, the coreflooding results highlight the significance of achieving miscibility during gas injection, as the ultimate recovery factor increased from 65.5% under immiscible conditions to 77.2% using chemical-assisted methane, and to 79% using gas mixture after achieving near miscible condition. The results demonstrate the promising potential of the MMP reduction to significantly increase the oil recovery factor during gas injection. Furthermore, these results will likely expand the application envelop of the miscible gas injection, in addition to the environmental benefits of utilizing the produced gas by re-injection/recycling instead of flaring which contributes to reducing the greenhouse gas emissions.

6.1. Introduction

Fossil fuels will likely remain essential for the remainder of the 21st century to meet the global demand from different industrial sectors [2-4, 114]. Typically, only one third of the original oil in place (OOIP) can be produced after primary and secondary recovery stages [2, 5-8]. This means that roughly 70 % of the OOIP remains in the subsurface. Therefore, enhanced oil recovery (EOR) techniques are necessary to unlock the significant remaining hydrocarbon resources in the reservoirs. In particular, gas injection EOR is the most widely applied recovery technique for light and medium crude oil reservoirs [13-15, 64]. This method, which results in an additional oil recovery between 10% and 25% of the OOIP [93-95], is generally considered to be both cost-effective and relatively environmentally friendly [120, 121]. In particular, miscible gas injection has been the centre of attention in the

petroleum industry due to a much higher sweep efficiency and displacement efficiency compared to immiscible gas injection [21-23, 25, 96, 122].

A few mechanisms have been identified to achieve high sweep and displacement efficiency by gas flooding [20, 123, 124] such as oil viscosity reduction, oil swelling and gas-oil interfacial tension (IFT) reduction [16-19, 125]. However, for certain reservoirs (e.g., high temperature reservoirs or shallow reservoirs) achieving miscibility is not always possible due to the high pressure required to achieve the minimum miscibility pressure (MMP) between gas and oil phases, which likely exceeds the formation fracture pressure [32, 97]. Therefore, most of the miscible hydrocarbon gas injection projects were applied within certain screening criteria such as light crude oil (34 - 44 API), reservoir depth (4200 - 6700 ft), reservoir temperature (308 - 344 K) [98, 99]. In this context, chemical additives (typically, surfactant-like compounds) can be added to the gas-oil system to assist the miscibility process and potentially switch from immiscible to miscible or near miscible injection conditions, and thus extend the screening criteria limits of the miscible hydrocarbon gas injection to more candidate reservoirs. In particular, this could be more beneficial for high temperature reservoirs where the MMP increases with increasing the temperature, and for the shallow reservoirs where the low formation fracture pressure is considered a limitation on the maximum allowable injection pressure [97]. Therefore, using chemical additives to reduce the gas-oil MMP seems to be a promising technique which combines the benefits of interfacial tension reductions and the improved displacement efficiency that can potentially increase the oil recovery factor.

In this context, several recent studies investigated the potential of chemical additives to reduce the MMP between CO₂ and crude oil. The existing literature shows that adding chemical additives (e.g. surfactants, alcohols and carboxylic acids) to the CO₂-oil system with concentration between 0.1 wt. % to 10 wt. % can reduce the MMP by up to 22% [32,

67-70, 74, 104, 126]. Furthermore, the existing literature shows that surfactants with CO₂-philic groups (e.g. polyoxyethylene and polyoxypropylene) are the most effective additives for enhancing miscibility in CO₂-oil system [127]. However, there is a lack of research in similar approaches to reduce the MMP in natural gas-oil system, which is considered more challenging as it typically results in a much higher initial MMP (around two or three times) compared to CO₂ [92], leading to immiscible gas injection at *in-situ* reservoir conditions, and thus a higher residual oil saturation. Therefore, there is a pressing need to investigate the potential of achieving the miscibility between natural gas and crude oil at lower pressures by adding chemical additives or by adding other gases to enrich the natural gas and to assist the miscibility process. In addition to its low cost and availability, utilizing the produced natural gas by re-injection/recycling instead of flaring/venting will have a significant environmental benefit as it will contribute to reducing the greenhouse gases and achieving the net zero-carbon emissions target.

In our previous work [128], we used interfacial tension measurements to investigate the effect of different surfactant-based and alcohol-based chemicals on the methane-oil miscibility. Similar to CO₂-oil system, the results show that surfactant-based chemicals performed better and achieved higher MMP reduction compared to alcohols, where the addition of the non-ionic alkoxyated surfactant to the methane-oil system resulted in 9% of MMP reduction at 373K.

The aim of this research is to test the potential application of the chemical-assisted MMP reduction in methane-oil system by investigating the effect of MMP reduction on the oil recovery factor. In order to achieve this objective, firstly, we measured the MMP of the gas-chemical-oil system and gas mixture-oil system to estimate the MMP reduction compared to the base case (methane-oil system). Afterwards, we performed three coreflooding experiments to quantify the effect of MMP reduction on the oil recovery factor. The first

coreflooding experiment was performed under immiscible conditions to serve as the base case. Then, two experiments were performed at near miscible conditions after adding surfactant based chemical and CO₂ to methane under secondary and tertiary recovery modes to quantify the MMP reduction effect on the ultimate oil recovery.

6.2. Methodology

6.2.1. Material

Crude oil: The used crude-oil sample was collected from a high temperature reservoir in Western China. Acid and base numbers of the crude oil are of 3.98 mg KOH/g and 1.3 mg KOH/g respectively, where the oil density and viscosity were 0.85 g/cm³ and 5.23 mPa.s respectively at the standard conditions.

Gas: Pure methane (99.99 mol %) and gas mixture (CH₄ 80 mol % and CO₂ 20 mol %) were purchased from Coregas, Australia. It is worth mentioning that, the pure methane gas was used to represent natural gas and to simulate the field conditions. However, the gas is normally mixed with different gas impurities in the typical field applications, which certainly affects the miscibility pressure. In particular, methane gas has the lowest critical temperature compared to other hydrocarbon gases and hence it has a higher MMP. Therefore, pure methane gas injection could be challenging as it requires the highest pressure to achieve miscibility compared to CO₂ and other hydrocarbon gases [102].

Brine: A synthetic brine was prepared by dissolving NaCl and Cl salts (125 g/l NaCl and 15 g/l KCl) into de-ionized water, where the concentration of the total dissolved solid (TDS) was 140 g/l.

Core samples: Berea sandstone core samples were used in the experiments, where the average core diameter and core length were measured to be 3.8 cm and 7.6 cm respectively (2 core

plugs were used in each experiment), with average absolute permeability of 110 mD and porosity of 19.2%.

Chemical Additives: Non-ionic alkoxyated surfactant (SOLOTERRA ME-6) were used in this study due to its promising results in improving methane-oil miscibility in our previous work. The selected surfactant contains a propoxy functional head group and a lipophilic hydrocarbon chain, which is soluble in oil and it has low solubility in water due to its low hydrophilic-lipophilic balance (HLB) value of 5.6 Davies. The chemical was supplied by SASOL Performance Chemicals.

6.2.2. Experimental Procedures

6.2.2.1. Interfacial Tension

In this study, the gas-oil interfacial tension was measured by the pendant drop method [19, 56, 129, 130] using the IFT700 equipment (Vinci-Technologies) as shown in Figure 6.1.

Afterwards, the vanishing interfacial tension (VIT) technique was used to estimate the MMP values [40, 46, 52-54]. In the VIT method, the measured gas-oil IFT data is extrapolated using linear regression to intercept with the pressure axis (x-axis), where the intercept represents the estimated minimum miscibility pressure [40, 60]. The IFT experiments were conducted at a constant temperature (373 K) and within a pressure range between 5 and 37 MPa.

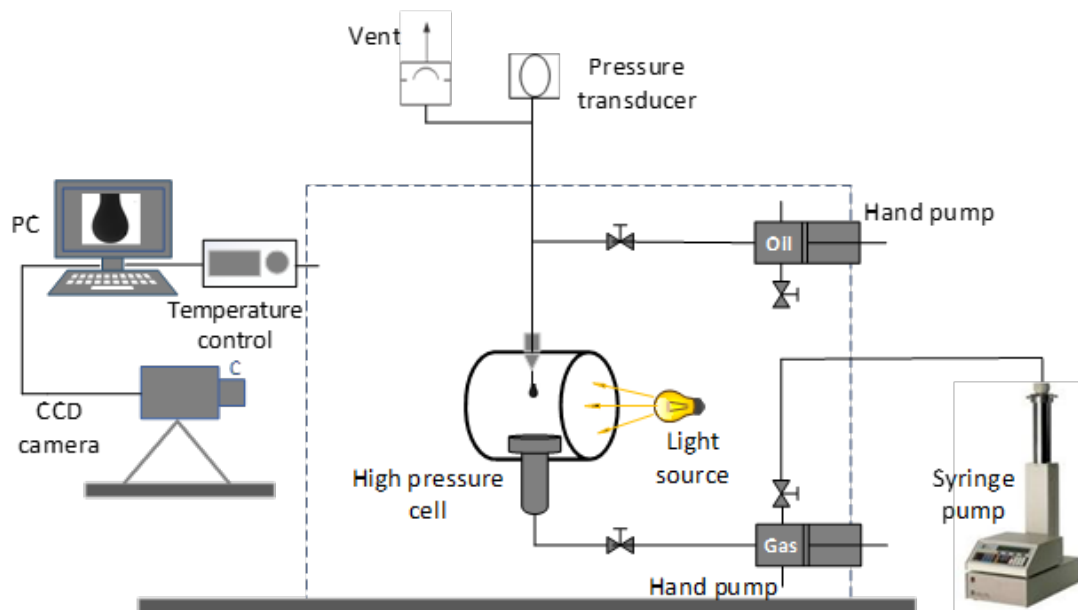

Figure 6.1 Schematic diagram of the interfacial tension equipment [128].

First, the IFT cell was thoroughly cleaned before each experiment using acetone and toluene, then the system was connected to a vacuum pump for 12 hours to dry. Afterwards, the gas is injected and pressurized into the IFT cell using the connected syringe pump, where the system temperature is controlled using the pre-installed heater in the IFT equipment. The experiment starts at a certain pressure and temperature by introducing an oil drop into the cell, where the drop shape is recorded using the CCD camera and the IFT value is calculated using the drop shape analysis software. Afterwards, another oil drop is introduced into the cell and the IFT measurements is repeated (under the same conditions) to confirm the repeatability of the results. Throughout the measurements, the IFT values were found to be reproducible within $\pm 0.4 \text{ mN/m}^1$, where the final estimated IFT values in this research were based on the average measurement of three different oil drops at each pressure point.

When the chemical was used in the experiment, few steps were added to the above procedure to dissolve the added chemical into the gas phase according to the weight percentage [29, 70]. First, a calculated amount of the chemical was placed on the plate inside the cell. Then, the gas was introduced into the cell to mix with the chemical under experimental pressure and

temperature conditions. Then a sufficient time was given to ensure a proper mixing between chemical and gas phase.

6.2.2.2. Coreflooding

In this work, three coreflooding experiments were performed using different injection scenarios to investigate the effect of reducing MMP of the methane-oil system on the oil recovery factor. The experiments were performed under the same pressure (28.6 MPa) and temperature (373 K) using a constant injection rate of 1 cc/min. It is worth noting that the experimental conditions of the temperature (373 K) were selected to represent high temperature reservoirs, and the pore pressure of 28.6 MPa was selected under MMP to represent immiscible injection conditions. Figure 6.2 shows a schematic diagram of the used coreflooding setup which contains four accumulators for the used injection fluids, one core-holder and a heating system to control the temperature. Three positive displacement syringe pumps were used to provide a constant injection rate and a constant overburden and pore pressures which is controlled using a back-pressure regulator (BPR); digital pressure transducers were used to monitor and record the differential pressure across the core plug. Graduated cylinders were used to measure the produced oil, where the produced gas was safely vented into the fume cupboard.

The permeability and porosity of the used core samples were initially measured using the automated Gas Permeameter-Porosimeter (AP-608 instrument). For each experiment, the core samples were wrapped into a heat shrink and inserted into a rubber sleeve and placed inside the core-holder and subsequently vacuumed for 12 hours. Afterwards, the synthetic brine was then injected into the porous system to gradually increase the pore pressure whilst maintaining an overburden pressure of 6.8 MPa higher than the pore pressure. Afterwards, the brine was injected continuously at a flow rate of $1-2 \text{ cm}^3 \cdot \text{min}^{-1}$ for 24 hours to ensure that the core sample was completely saturated with the brine which is verified by a stable differential pressure across the core. Subsequently, the brine was injected at different flow

rates (0.5, 1, 2 and 4 cm³·min⁻¹) to calculate the absolute permeability. Then the dead oil was injected into the saturated core at a constant rate of 0.2 cm³·min⁻¹ for two days until there is no more water produced to calculate the irreducible water saturation and the oil in place.

It worth noting that the used chemical was mixed with the gas in the accumulator before injection, as the chemical is completely soluble with the gas phase under the experimental conditions, where mixing the chemical with the injected gas better simulates the actual field application [131].

The experiment starts by injecting the gas phase under secondary recovery mode at a constant flow rate of 1 cm³·min⁻¹ until there is no more oil produced, then the tertiary recovery is started. The gas injection was stopped when the ultimate recovery was almost achieved, which occurred after the injection of 15 pore volumes (PV). At the end of each experiment, the oil recovery factor was plotted against injected pore volume. Table 6.1 shows a summary of the rock properties of the tested core samples and the injection scenarios for the coreflooding experiments.

Table 6.1 Rock properties of the tested core samples (gas mix is 80/20 mole:mole CH₄/CO₂) *

Core	Recovery mode	Injection fluid	porosity Φ	S _{wi}	PV (cc)	K (mD)
Core 1	Secondary	Methane	19.3%	32.0%	32.7	108
	Tertiary	Methane + Surfactant				
Core 2	Secondary	Methane + Surfactant	19.2%	31.4%	32.5	110
Core 3	Secondary	Gas mix (CH ₄ + CO ₂)	19.5%	26.6%	33.1	117

* Φ, porosity; PV, core pore volume; K, absolute permeability.

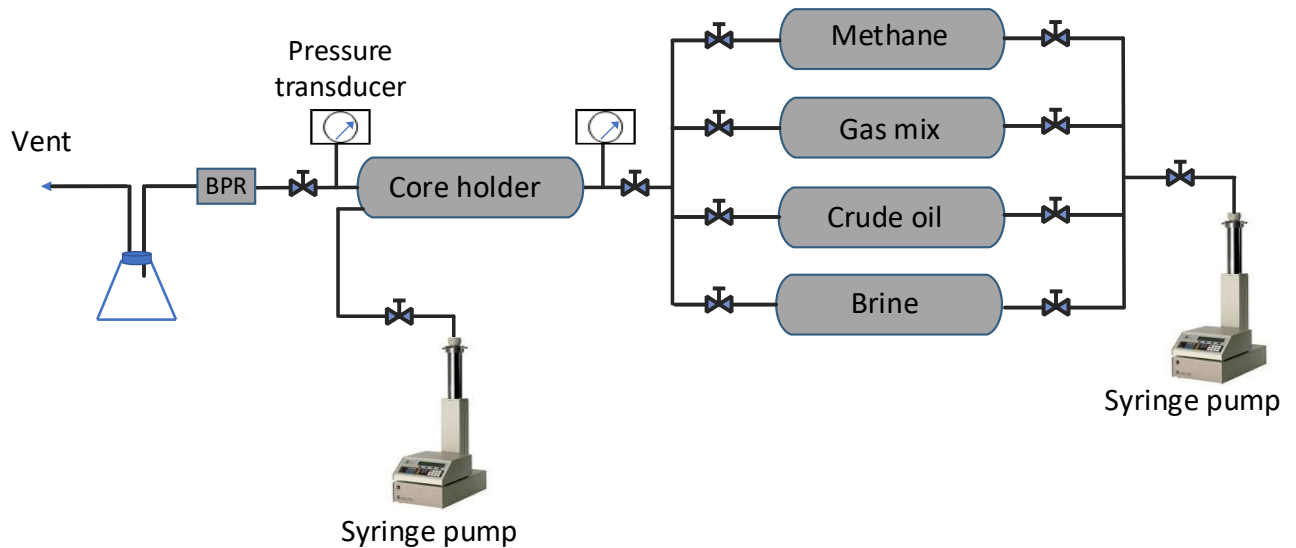

Figure 6.2 Schematic diagram for coreflooding setup.

6.3. Results and Discussion

6.3.1. Methane-Oil MMP Reduction

First, the MMP value between pure methane gas and crude oil was used as the base case to determine the MMP reduction after adding chemical or CO₂ in the following experiments. In our previous work, the MMP between methane and the same crude oil (base case) was measured to be 31.7 MPa, where the first contact miscibility (FCM) pressure was 64.8 MPa. as shown in Figure 6.3 [132]. As the results indicate, increasing the system pressure decreases the IFT of the methane-oil system at all pressure values. The IFT reduction between the two fluids could be due to the dynamic interactions (mass transfer) between the two fluid phases, as the molecules are attracted between the two fluids by dispersion and dipole intermolecular forces [133, 134], where increasing the pressure improves the extraction and condensation processes between gas and crude oil molecules. In this fluid interaction, the light crude oil components are vaporized (extracted) into the gas phase, and the enriched gas phase condenses into the crude oil [19, 29, 32, 69, 108]. Therefore, the multi-contact miscibility is developed and achieved due to the improved extraction and condensation processes [31, 110, 111].

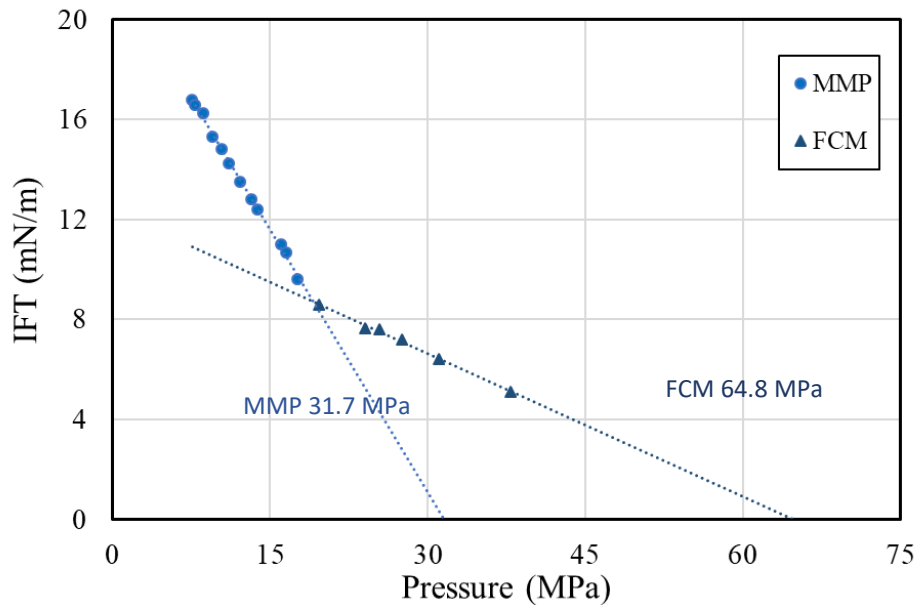

Figure 6.3 IFT of CH₄-oil at 373 K as a function of pressure without chemical additives [132].

In the following experiments, the effect of the chemical-assisted methane and the gas mixture on the equilibrium IFT were measured and plotted with comparison to the base case as shown in Figure 6.4. Firstly, for the chemical-assisted methane (the red line in the Figure 6.4), the IFT results show that adding surfactant to the methane-oil system decreases the IFT values through all the studied pressure values, consequently the MMP decreased in the presence of chemical from 31.7 MPa to 28.8 MPa, which represents 9% of MMP reduction compared to the original case. In this experiment, chemical-assisted MMP reduction has been tested by adding 1.5 wt.% of the tested surfactant (SOLOTERRA ME-6) into the gas-oil system. In the presence of surfactant, improved miscibility conditions of vaporization and condensation facilitate the methane-oil IFT reduction. Similar to the CO₂-oil system, the surfactant molecules would be adsorbed onto the gas-oil interface, while the propoxy functional head groups of the surfactant interact with methane molecules and the lipophilic hydrocarbon tail attaches to the oil molecules [70, 81, 89]. This process in turn improves the extraction capacity of the methane and leads to enlarging the miscibility zone and reducing the gas-oil

the interfacial tension, which promotes further condensation and vaporisation processes until achieving miscibility.

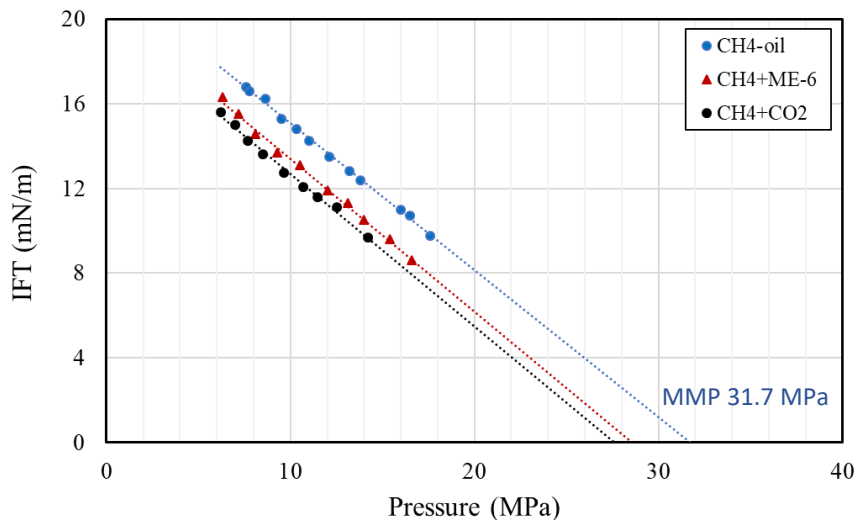

Figure 6.4 IFT of gas-oil system with chemical and gas mixture (CH₄ 80 mol % and CO₂ 20 mol %) without chemical compared to pure methane-oil system at 373 K.

Secondly, for the gas mixture (CH₄ 80 mol % and CO₂ 20 mol %) without chemical (the black line in Figure 6.4), the equilibrium IFT shows slightly lower values at all pressure points compared to chemical-assisted methane, where the estimated MMP was 27.5 MPa, which represents 13% MMP reduction compared to the original MMP value of 31.7 MPa.

The observed IFT reduction using the gas mixture could be attributed to the improved solvation power in the presence of CO₂, where the critical temperature of CO₂ gas (304 K) is much higher compared to methane gas (190 K) [29], in addition to the higher intermolecular forces between CO₂ molecules due to the presence of much stronger quadrupole interactions between CO₂ molecule which operate at a shorter intermolecular distance compared to the dipolar interactions between methane molecules [100]. Therefore, the presence of CO₂ enriches the methane and improves its extraction ability and assists in developing vaporising and condensing processes [92], and thus reduces the miscibility pressure.

6.3.2. Effect of chemical-assisted gas injection

The objective of the core flooding experiments is to evaluate the effect of the MMP reduction on the oil recovery efficiency under different scenarios of secondary and tertiary recovery modes. During the experiments, a constant injection rate of 1 cc/min, injection pressure of 28.6 MPa and temperature of 373 k were maintained constant throughout the experiments. In the first experiment, pure methane was injected in the secondary mode under immiscible injection conditions, as the pore pressure was 28.6 MPa which is lower than the MMP (31.7 MPa), then the injection was followed by chemical-assisted methane injection in the tertiary recovery stage. Figure 6.5 shows the recovery profile plotted against the injected pore volumes for the first experiment.

In the secondary recovery stage, pure methane injection (the blue line) recovers 37% of the OOIP prior to gas breakthrough which occurs after 0.33 PV of gas injection, then the injection stopped after 7 PV when there is no more oil produced at a total recovery of 60.5%. Afterwards, the tertiary recovery stage was started under the same experimental conditions using chemical-assisted methane injection (1.5 wt.% of ME-6 dissolved into the methane gas). As per the IFT experiments, the MMP was reduced to 28.8 MPa in the presence of the chemical, therefore the injection of the tertiary recovery was operated under near miscible conditions as due to the chemical-assisted MMP reduction. As shown in Figure 6.5 (the orange line), chemical-assisted methane injection at tertiary mode shows a slight increase of oil recovery, which resulted in a 5% of incremental oil recovery after the injection of 8 PV, where the ultimate oil recovery was 65.5% at the end of the injection (15 PV). This experiment represents the base case to measure the additional recovery using chemical or gas mixture in the following experiments.

The oil recovery at the secondary stage was mainly driven by the immiscible gas injection which typically has a poor sweep efficiency due to the unfavourable mobility ratio between gas and oil phases, which leads to bypassed oil and an early gas breakthrough, hence a lower recovery factor compared to the miscible flooding [135]. In the tertiary recovery stage, the surfactant was dissolved in the gas phase and then injected into the core plug, the presence of the surfactant assisted in reducing the gas-oil IFT and consequently achieving the near miscible conditions, therefore a slight gradual increase of oil recovery was observed during the injection. However, the ultimate recovery factor did not significantly increase due to the fact that some of the oil in place in the pore spaces were already bypassed during the immiscible injection [136].

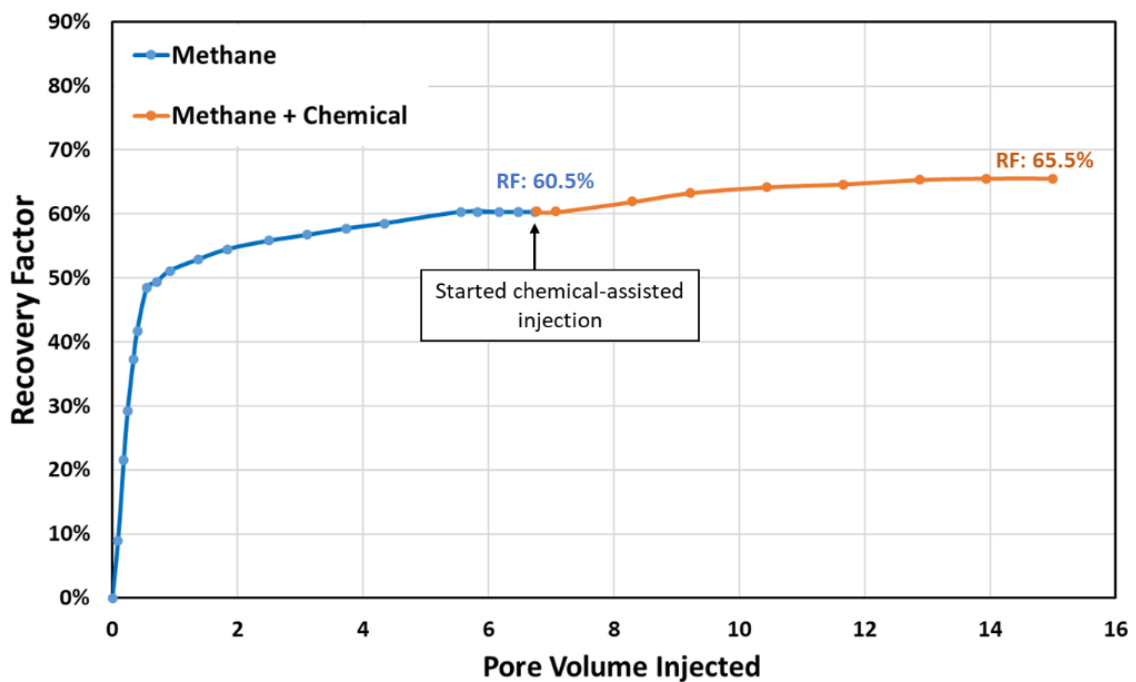

Figure 6.5 1st experiment: Secondary recovery factor using CH₄ at immiscible conditions, and tertiary recovery using chemical-assisted CH₄ (core 1).

The objective of the second experiment is to test the effect of chemical-assisted MMP reduction on the ultimate oil recovery factor in the secondary mode. Based on the IFT results, the injection process was performed under near miscible conditions, as the estimated MMP

decreased to 28.8 MPa in the presence of surfactant, while the injection pressure (pore pressure) is kept constant at 28.6 MPa.

As shown in Figure 6.6, applying chemical-assisted methane injection at secondary mode resulted in a higher ultimate recovery factor compared to the base case. In other words, the ultimate recovery factor in the second experiment is 77.2% compared to 65.5% in the base case for the same injected pore volume (15 PV) which represents a significant increase of 11.7% over the first experiment. Furthermore, the gas breakthrough was delayed in the presence of surfactant as it occurred after 0.39 PV of gas injection compared to 0.33 PV in the first experiment without chemical.

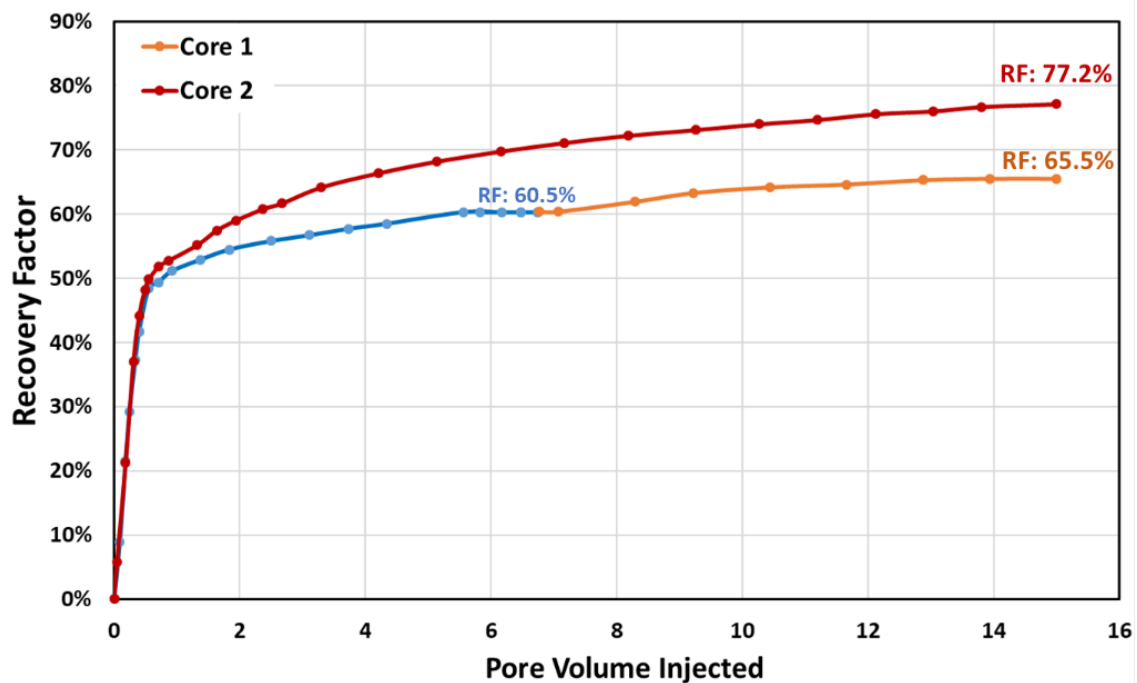

Figure 6.6 2nd experiment: Secondary recovery using chemical-assisted CH₄ at 373K (Core 2) compared to the 1st experiment (Core 1).

Typically, reducing IFT in gas-oil system increases capillary number (N_c) and results in reducing residual oil saturation [20, 137]. In this experiment, the methane-oil IFT was effectively reduced using surfactant due to the gas-chemical-oil interactions, as the amphiphilic surfactant molecules are adsorbed into the gas-oil interface, and the hydrocarbon

chain of the surfactant is attached to the crude oil, and the slightly negative oxygen atoms in the polar head-group (propoxy group) interacts with the slightly positive hydrogen atoms of the methane. This arrangement facilitates the extraction process of the light oil components into the gas phase and assists in achieving miscibility. Moreover, the enhanced extraction and vaporisation processes resulted in delaying gas breakthrough and allowed more time for the injected gas to interact with crude oil in the pore space, and consequently improved the microscopic sweep efficiency and thus a higher ultimate oil recovery factor was achieved under the same injection conditions (pressure and temperature).

Furthermore, the results highlight the significance of selecting the proper time to start EOR techniques. To be more specific, applying chemical-assisted gas injection is more beneficial at the early injection stages, as the incremental recovery was significantly higher when the chemical-assisted injection started in the secondary recovery mode compared to the tertiary mode. This phenomenon is quite similar to low salinity water (LSW) flooding and polymer flooding, where the EOR process becomes more effective if applied in the early injection stages (secondary recovery compared to tertiary recovery) [20, 138, 139]. The lower recovery factor when applying EOR methods in later stages could be due to the unfavourable mobility ratio which leads to an early breakthrough of the injected fluid and a massive amount of bypassed oil and hence a poor microscopic sweep efficiency [140] using immiscible injection in secondary mode, which reduces gas-oil interaction of miscible injection if applied in tertiary recovery afterwards. Therefore, applying miscible or near miscible injection at the early stage may better improve the microscopic sweep efficiency and allow more time for chemical-gas-oil interaction, as observed in the experiment by a delayed gas breakthrough in the coreflooding, resulting in higher oil recovery factor.

6.3.3. Effect of Gas Mixture on the Recovery Factor at Secondary Mode

Figure 6.7 shows the recovery profile of the gas mixture (CH₄ 80 mol % and CO₂ 20 mol%) without chemical compared to the chemical-assisted methane injection at the secondary mode. In this experiment, the injection was performed under near miscible conditions, as the MMP decreased from 31.7 to 27.6 MPa in the presence of 20 mol % of CO₂ according to the IFT measurements. As indicated in Figure 6.7 the oil recovery profile using CO₂ shows almost a similar overall performance compared to the chemical-assisted methane, where the ultimate recovery factor achieved using gas mixture is 79%, which is 1.8% higher than chemical-assisted methane injection and 13.5% higher than pure methane (immiscible condition).

Indeed, the presence of CO₂ enriches the methane and increases its density resulting in reducing IFT and delaying gas breakthrough [17] and allowing more time for gas-oil interaction, in addition to the effects of oil viscosity reduction and oil swelling which further improve the mobility ratio [16, 28, 141], and consequently enhance the extraction of heavier crude oil components, and thus a higher recovery factor compared to pure methane. In this context, composition of the injected gas has a major influence on the gas-oil miscibility as it determines the interactions at the interface [91, 142]. Therefore, in the field application, gas impurities can have a significant impact on the gas-oil MMP and the overall feasibility of the EOR process. However, to the best of our knowledge, this is the first study to investigate the effect of chemical-assisted IFT reduction on the oil recovery factor for the methane/natural gas injection at core scale.

Table 6.2 includes a summary of the core-flooding experiments and their results.

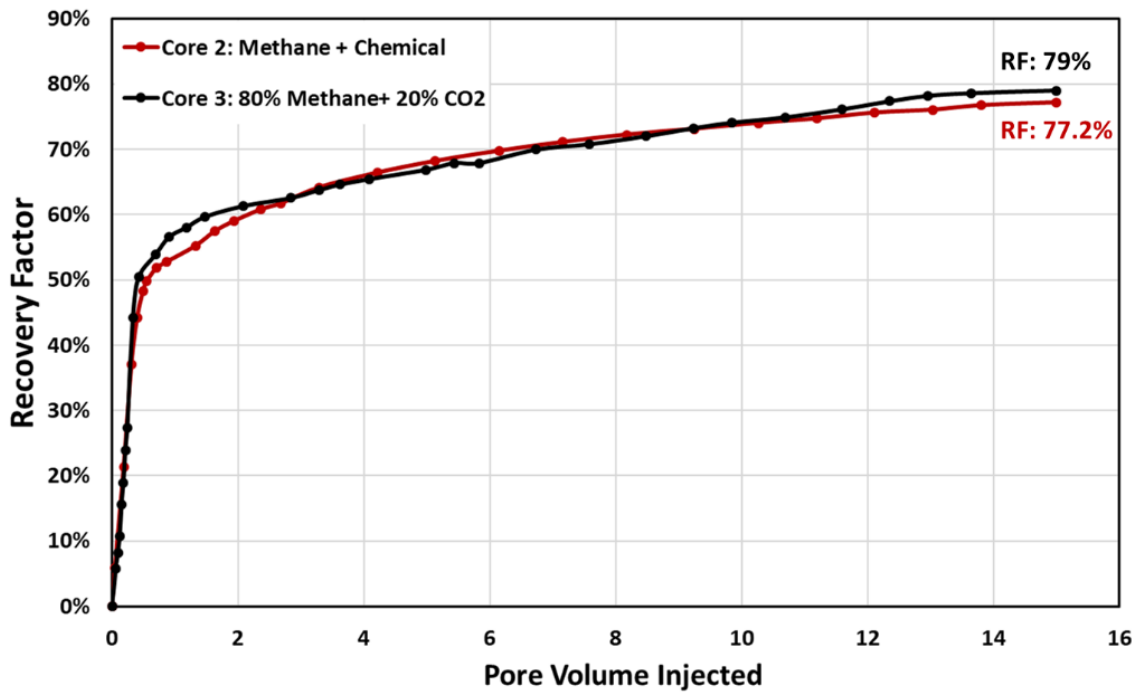

Figure 6.7 Recovery factor of gas mixture compared to chemical-assisted methane at 373 K (cores 2 & 3).

Table 6.2 Summary of coreflooding results*

Core	Injection mode	Injection fluid	porosity Φ	PV (cc)	K (mD)	S_{wi}	Total RF
Core #1	Secondary	CH ₄	19.3%	32.77	108	32.0%	60.5%
	Tertiary	CH ₄ + surfactant					65.5%
Core #2	Secondary	CH ₄ + surfactant	19.2%	32.53	110	31.4%	77.2%
Core #3	Secondary	CH ₄ + CO ₂	19.5%	33.11	117	26.6%	79.0%

* Φ , porosity; PV pore volume; K, absolute permeability; S_{wi} , initial water saturation; and total RF, ultimate oil recovery factor.

This work aims to investigate the potential application of chemical-assisted MMP reduction to increase the oil recovery factor at core scale. The preliminary results demonstrate a promising potential of using chemical additives to improve the miscibility between

methane/natural gas with crude oil. Therefore, chemical-assisted MMP reduction appears to be a practical EOR technique not only to increase the ultimate recovery factor at the same injection pressure but also to reduce the greenhouse gas emissions through utilizing the produced gas by re-injection/recycling instead of flaring.

In the field application, a calculated amount of the desired chemical is to be mixed with the gas stream and injected downhole. However, feasibility and application of this method is highly dependent on the cost and concentration of the used chemical. Therefore, further experiments are required to optimize the chemical type and concentration for each specific reservoir condition.

Typically, CO₂ is an ideal injection gas for EOR with low MMP and high injectivity compared to other gases [120, 126]. However, in case of limited CO₂ availability, chemical-assisted MMP reduction (using natural gas) represents a good alternative to achieve the miscibility and to increase the oil recovery factor, where the coreflooding results show that a small fraction (1.5 wt.%) of surfactant-based chemical can be almost as effective as adding 20 mol % of CO₂ to the methane. In addition, it would eliminate possible problems associated with CO₂ like corrosion and asphaltene precipitation. To the best of our knowledge, this is the first study to investigate the potential of MMP reduction using chemical additives on the recovery factor of the methane-oil system.

6.4. Conclusion and Implications

In this study, we presented a novel investigation to quantify the effect of chemical-assisted MMP reduction on the oil recovery factor during methane gas injection at core scale. First, the interfacial tension of the methane-oil system was measured after adding surfactant and CO₂ respectively. Afterwards, three coreflooding experiments were performed to quantify the effect of the MMP reduction on the oil recovery factor under different scenarios. The IFT

measurements show that dissolving 1.5 wt.% of surfactant based chemical (SOLOTERRA ME-6) into the methane-oil system was able to reduce the MMP from 31.7 to 28.8 MPa (9% reduction), while adding 20 mol % of CO₂ achieved 13% MMP reduction. The coreflooding results demonstrated the significance of achieving miscibility during gas injection, as the ultimate recovery factor increased from 65.5% under immiscible conditions to 77.2% using chemical, and to 79% using gas mixture (CH₄ 80 mol % and CO₂ 20 mol %) after achieving near miscible conditions.

These results likely expand the application envelop of the miscible methane/natural gas injection to more candidate reservoirs, which consequently results in higher oil recovery factor, in addition to the potential environmental benefits of utilizing (re-injection/recycling) the produced gas which will have a significant impact on reducing the greenhouse gas emissions.

The main findings from this study could be summarized as follow:

- Chemical-assisted MMP reduction is a promising technique to reduce the MMP in methane/natural gas-oil system.
- Confirmed the potential of chemical-assisted MMP reduction at core scale, as the ultimate oil recovery factor increased by 11.7% compared to the immiscible conditions.
- Chemical additives as low as 1.5 wt.% could be as effective as adding 20 mol% of CO₂ to the injected methane, which is beneficial in case of limited CO₂ availability.
- Chemical-assisted MMP-reduction is more beneficial in secondary recovery compared to tertiary recovery.

Chapter 7 Data Analysis of MMP in Hydrocarbon Gas-Oil System

7.1 Problem Statement

To date, there is no robust correlation to predict the MMP in hydrocarbon gas-oil system [143, 144]. Only few correlations exist with a limited number of data points, which is only applicable to a specific reservoir or to a narrow experimental condition. Therefore, the objective of this chapter is to utilize data analysis techniques to identify the main controlling factors of the miscibility process under a wide range of conditions, which consequently assists in gaining a better understanding of MMP prediction and potential reduction. To achieve this objective, firstly, literature review of the main existing correlations is presented in this chapter. Secondly, available experimental data was collected from the literature to build a comprehensive database of gas and oil properties and the corresponding MMP. Then, data exploration, visualization, and analysis techniques were utilized to identify the controlling parameters of the miscibility and to come up with some insights to optimize the injection/miscibility process. Afterwards, the insights from this analysis will be used as an input to build a machine learning model to predict the MMP in the next chapter, which will enable an accurate prediction of potential MMP reduction based on gas injection composition.

7.2 Literature Review

Predicting MMP in gas-oil system using analytical methods is considered as a good alternative to the lengthy and expensive laboratory experiments [145]. Therefore, there was an early interest in the petroleum industry to generate a correlation to predict the MMP in a given gas-oil system based on some input parameters. For example, in 1960 Benham et al. [146] presented an empirical curves to estimate the miscibility conditions using rich gas in the pressure range between 1,500 to 3,000 psi. Afterwards, several correlations were

proposed to predict the MMP in different gas-oil systems. However, there are much less correlations to predict MMP for hydrocarbon gases compared to the available correlations for CO₂, and N₂ gases [5, 143, 144], which could be due to the fact that CO₂ is the most widely used gas for miscible gas injection projects or due to the complex nature of miscibility process using a rich gas or a gas mixture [145]. In this context, the aim of this section is to highlight the main existing correlations for MMP prediction in hydrocarbon gas-oil systems.

Glaso [147] presented a generalized correlation to predict MMP for multi-contact miscible (MCM) displacement by hydrocarbon, CO₂, and N₂ gases based on Benham et al.'s graphical correlation [146]. In this work, the MMP was given as a function in the reservoir temperature, molecular weight of C₇₊ in the crude oil, mole percent of methane in the injected gas, and the molecular weight of the intermediates (C₂ through C₆) in the gas. In this correlation, the MMP was assumed to increase in a linear relationship with the temperature, which resulted in increasing the prediction error outside the experimental data range. The produced correlation predicts the MMP at different injected gas molecular weight (C₂ through C₆), where the other input values calculated by interpolation. Moreover, Glaso reported that several other factors could affect the accuracy of the correlation. For example, a deviation of 5 – 10% in the C₇₊ measurement could lead up to 8% error in the estimated MMP value.

In another work, Kuo et al. [148] derived a correlation to estimate the MMP of the enriched gas drive using Peng–Robinson equation of state (EOS). The proposed model depends on the temperature, pressure, molecular weight of C₅₊ of oil, and molecular weight of C₂₋₄ fraction in the injected gas as input parameters to estimate the maximum allowable methane concentration to achieve the MMP. Afterwards, Kuo et al. performed five slim tube experiments to test the accuracy of the proposed correlation comparing to the experimental results. They reported that the correlation predicts the MMP with average error of ±4% and maximum error of 6%. However, this correlation is only applicable or reliable within a

narrow range of experimental conditions. For instance, the correlation is limited to a pressure range between 1,500 to 4,000 psia and a temperature range between 130 and 260 °F.

In another effort, Firoozabadi et al. [149] presented a correlation to predict the MMP in vaporizing gas drive (VGD) condition, which is mainly applicable to N₂ or lean gas injection but not applicable to rich hydrocarbon or CO₂ gases. Moreover, they performed 13 slim tube experiments to validate and test the correlation, they also argued that Peng–Robinson EOS overestimates the MMP.

Typically, in vaporizing gas drive the miscibility is assumed to be achieved through the gradual vaporization of the light crude oil components into the gas phase. Therefore, the input parameters for the correlation consisted only of crude oil properties in addition to the temperature. In this correlation, the temperature behaviour followed a power-law model with a negative exponent which means that the effect of temperature on the MMP decreases at higher temperature values. Furthermore, they concluded that the behaviour of VGD for N₂ is close to the behaviour of lean gas, however, the difference becomes larger at lower temperature.

Eakin and Mitch developed a generalized correlation to predict the MMP using the rising bubble apparatus (RBA) experimental method [150], they performed 102 experiments using different gas and oil compositions at temperatures 180 and 240 °F. Temperature, composition of the solvent, and molecular weight of C₇₊ fraction in the crude oil were used as input parameters for the correlation. The reported accuracy for the correlation is ± 5% of the experimental results, with few points up to 15% deviation outside this error range.

EOS Based Correlations

Yurkiw (1994) [151] evaluated the accuracy of 15 lean gas, rich gas, and N₂ correlations to estimate the MMP. He reported that none of the tested correlations is sufficiently accurate to

use for MMP prediction. However, he observed that the most accurate MMP correlations were developed based on EOS calculations.

In another effort, Noel 2002 [152], published a comprehensive PVT database of more than 5000 points for the evaluation and prediction of phase behaviour. The given database was related to 13 different crude oil properties from different reservoirs, in addition to the data of 15 slim tube experiments. This database was used by several researchers afterwards for EOS tuning [145].

Maklavani et al. 2010 [153], derived an empirical correlation to estimate the MMP for hydrocarbon gas injection through multi-contact miscibility displacement. The correlation was developed using a compositional slim tube simulator using the modified Peng-Robison equation of state (EOS) with more inputs to represent the reservoir fluid properties in order to better simulate the complex process of condensing/vaporising gas drive in the model. They reported an average absolute deviation (AAD) of 4.4% by the proposed correlation. However, the investigated range was limited within a limited temperature range between 129 to 300 °F, and methane concentration between 6 to 55 mole%.

In another work, McGuire et al. (2016) [154] published EOS based MMP data using 11 different crude oil composition and different gas injection compositions to evaluate the potential of ethane injection in case of low CO₂ availability. However, they reported a significant uncertainty in the accuracy of the calculated MMP.

In similar effort, He et al. (2020) [155], proposed a new correlation based on the EOS to predict the MMP in the produced gas, which is normally a mixture of hydrocarbon gas, CO₂, and H₂S. Afterwards, they compared the correlation's results to the results of 20 slim tube experiments in the literature. The correlation was found to estimate the MMP with an average relative error of 6.4%, where the applicable range of the correlation is between 90 to 330 F,

MWC₇₊ between 183 to 302 g/mol, C₁ molecular percentage 10 – 91.7%, CO₂ molecular percentage 0 – 45%, and H₂S molecular percentage 0 – 45%.

The above summary demonstrates the limited accuracy and application range of the existing hydrocarbon gas-oil MMP prediction correlations. Therefore, the aim of this work is to utilize data analysis techniques to gain a better understanding of the underlying correlations between the different controlling factors of the miscibility process in the hydrocarbon gas-oil system.

7.3 Data Collection

Collection of accurate data is an essential step to maintain the research integrity and to come up with reliable results. Therefore, in this research, a comprehensive database of MMP data was collected from the literature to gain some insights into the factors controlling the miscibility process. However, for MMP data in hydrocarbon gas systems, the data collection is a challenging task due to the limited availability of MMP data in the literature.

Furthermore, different researchers have used different input parameters in their calculations, so not all the required parameters/properties are available at all data points. For example, for crude oil composition, some researchers used the molecular weight of heptane plus (C₇₊) to represent the crude oil composition where others used the molecular weight of pentane plus (C₅₊) to represent the same crude oil property. Therefore, in order to solve this problem, some researchers have used PVT correlations to estimate the unreported properties, but there are still missing values at some points [145].

In this work, a comprehensive database of 153 MMP points was collected from the published literature from 1960s up to 2020. Then, the data quality was checked in the following step of data exploration. It is worth noting that all the MMP data points were measured only by the slim tube method to eliminate the possible error from using different MMP measurement methods in the same calculation. However, even within the same measurement method there could be

minor differences due to some uncertainties related to the experimental conditions. For example, in the slim tube experiment which is the standard and most common method to measure the MMP, there is no standard design for the slim tube system as the tube length, tube diameter, and injection flow rate could change in each setup or experiment, which may lead to slightly different result [50].

As mentioned earlier in chapter two, the miscibility process depends on four main factors, namely, pressure, temperature, oil and gas compositions. Based on the literature review, in this work temperature value is used to represent reservoir temperature, molecular weight of heptane plus was used to represent the oil composition, and the critical gas temperature and methane content/percentage in the gas was used to represent the gas composition parameter, the preceding parameters were considered the input values to predict the MMP (the target parameter) which is represented by the pressure parameter.

Table 7.1 below shows a summary of the main data sources of the collected database sorted by reference with the number of points for each reference [62, 145, 147, 148, 150-153, 156-160].

Table 7.1 summary of number of MMP points for each of the main data sources.

Ref	Number of MMP points
ADNOC [145]	86
Noel [152]	14
Firoozabadi Aziz [149]	10
Others	43
Total	153

Table 7.2 below shows the complete database for the MMP points used in this study.

Table 7.2 Hydrocarbon gas-oil MMP database.

MMP	T (°F)	MWC₇₊ (g/mol)	C₁(%)	T_c (°R)	Reference
2000	220	248	43	490	Glasø
2000	105	243	32.9	518	Shelton
2200	171.1	291	10.3	545	Al-Ajmi
2399	170	215	52.9	485	Kuo
2480	177	262	10.9	538	Al-Ajmi
2615.7	245	214.8	32.5	535.8	ADNOC
2680	206	215	53.1	485	Kuo
2749	132	302	54.3	480	Kuo
3100	260	210.7	51.4	487.9	ADNOC
3204.5	215	256.5	58.1	460	Jaubert et al.
3400	250	186.9	70.1	425.3	ADNOC
3400	250	197	60	456	Deffrenne
3400	130	183	68.5	435	Williams
3400	130	183	69	433	Williams
3407.5	210	253.9	58.1	460	Jaubert et al.
3500	160	212	66.1	435	Firoozabadi Aziz
3500	140	217	65	441	Hutchinson
3545.7	264	175.6	53.2	484.5	ADNOC
3564	175	175	57	465	Pedrood
3600	250	197	80	390	Deffrenne
3600	160	212	69.3	432	Firoozabadi Aziz
3639.7	255	209.1	63	449.1	ADNOC
3649	132	302	62.4	455	Kuo
3700	250	197	64.8	432	Deffrenne
3700	160	212	65.2	440	Firoozabadi Aziz
3712	250	245.4	56.5	473.4	Jaubert et al.
3714.7	209	259.9	59.8	453.6	ADNOC
3714.7	215	244.2	59.4	454.8	ADNOC
3750	220	204.9	69	432.5	ADNOC
3754	140	180.5	100	343	Sebastian and Lawrence
3800	160	212	69.2	432	Firoozabadi Aziz
3806.3	248	207.2	81.1	387.7	Jaubert et al.
3815	198	237	65.1	445	Al-Ajmi
3879	132	302	65	441.3	Kuo
3900	255	206.6	65	444.5	ADNOC
3907	237	212.6	100	343	Adekunle

3916	140	156.2	80	390	Yurkiw and Flock
3952.7	272	213	76.5	410.9	ADNOC
3974	138.2	240.9	100	343	Srivastava et al.
3979.7	250	204.3	65.9	443.1	ADNOC
3986	237	196.9	80	390	Adekunle
4001.7	275	178.8	90.5	362.9	ADNOC
4014.7	230	208.6	76.9	398.6	ADNOC
4014.7	270	207	63.3	450.9	ADNOC
4064.7	275	165.6	83.8	381.3	ADNOC
4114.7	250	208.7	74.5	414.3	ADNOC
4137	215	212.6	100	343	Adekunle
4137.7	285	186.2	62.8	450.3	ADNOC
4139.7	278	190	83.2	382.6	ADNOC
4160.1	250	214.5	66.1	447.5	Jaubert et al.
4164.7	272	208.4	88.7	373.4	ADNOC
4200	172	185	68.9	433	Firoozabadi Aziz
4206.7	249	202.4	66	436.7	ADNOC
4214.7	245	191.3	79	399.2	ADNOC
4224.7	250	215	66.1	447.5	ADNOC
4251.7	241	189.7	68.2	433.2	ADNOC
4264.7	240	215.1	84.4	349.7	ADNOC
4264.7	272	202.4	88.7	373.4	ADNOC
4274.7	240	217.5	83.7	350.2	ADNOC
4292	248	202.1	81.1	387.7	Jaubert et al.
4314.7	250	211.9	88.3	366.5	ADNOC
4322	158	156.2	46.9	470	Yurkiw and Flock
4364.7	210	249.1	66.9	428.6	ADNOC
4364.7	250	214	72	421.8	ADNOC
4364.7	275	211.4	83.2	382.6	ADNOC
4400	250	186.9	87.5	367.7	ADNOC
4414.7	265	207.8	73.6	416.8	ADNOC
4464.7	250	192	75.2	410.4	ADNOC
4467	237	212.6	90.1	366	Adekunle
4480.5	230	220.9	76.7	404.5	Jaubert et al.
4487.8	215	196.9	70.3	424.6	Adekunle
4500	220	246.8	73.3	406.6	ADNOC
4500	200	214.9	72.3	415.9	ADNOC
4500	169	285	57.2	470	Al-Ajmi
4514.7	250	199	89.9	380.4	ADNOC
4514.7	265	207.9	77	408.4	ADNOC
4529.7	285	163.6	60.1	462.3	ADNOC

4534.7	260	214.2	73.4	411.2	ADNOC
4538.5	230	220.9	75.6	401.2	Jaubert et al.
4550	260	210.7	86.5	370.2	ADNOC
4564.7	237	199.5	82.1	354.9	ADNOC
4614.7	255	212	89.9	380.4	ADNOC
4650	254	213.7	68.4	425.7	ADNOC
4650	130	305	87.7	367	Gardner et al.
4664.7	220	206.8	76.6	399.1	ADNOC
4664.7	250	191	75.2	410.5	ADNOC
4664.7	226	209	84.3	380	ADNOC
4684.7	140	156.2	67.6	430	Yurkiw and Flock
4714.7	237	204.2	84.3	380	ADNOC
4739.7	232	175.9	84	382.8	ADNOC
4741.5	218	223.1	64.9	432.7	Jaubert et al.
4741.7	218	223.2	64.9	432.7	ADNOC
4750	238	208	76.9	398.3	ADNOC
4764.7	260	214.2	80.4	385	ADNOC
4764.7	215	244.2	86.9	365	ADNOC
4764.7	250	210	89.9	380.4	ADNOC
4764.7	260	210	86.7	370.1	ADNOC
4789.7	250	214	85.8	372.2	ADNOC
4814	180	197.3	75	409.3	Pedrood
4814.7	209	259.9	73.7	405.9	ADNOC
4825	258	258	76	400.7	NIOC
4825	270	271	77	405	NIOC
4828.7	218	223.2	86.1	370	ADNOC
4857.5	213	214.9	85.3	378.3	Jaubert et al.
4864.7	250	209	74.8	413.9	ADNOC
4864.7	250	192	93.4	356.7	ADNOC
4894.7	240	223.3	83.8	349.6	ADNOC
4900	232	238.7	76.6	403.9	ADNOC
4902	217	193	71	422	Lee and Reitzel
4902	217	193	86.6	370	Lee and Reitzel
4914.7	212	232.4	73.7	405.3	ADNOC
4934.7	280	190.5	74.8	409.7	ADNOC
4950	232	238.7	77.6	398.5	ADNOC
4960	232	238.7	78	407.1	ADNOC
4964.7	215	240.3	74	404.8	ADNOC
4964.7	280	190.5	86.3	371	ADNOC
4964.7	250	191	93.7	356	ADNOC
5014.7	250	201.6	77.7	403.4	ADNOC

5014.7	265	207.8	90.9	362.4	ADNOC
5050	250	216.1	73.9	408.8	ADNOC
5064.7	250	201.6	90.3	363.8	ADNOC
5064.7	250	208.5	85.2	372.5	ADNOC
5076	215	204	71	422	Lee and Reitzel
5076	215	204	86.6	370	Lee and Reitzel
5100	210	231	73.3	410	Glasø
5114.7	220	248.2	76.1	400.5	ADNOC
5164.7	218	212.1	87.5	366.7	ADNOC
5164.7	266	192	77.3	404.6	ADNOC
5164.7	237	248.4	77	398.9	ADNOC
5200	250	213.9	94	357	ADNOC
5205.5	250	212.9	73.1	411	Jaubert et al.
5224.7	250	212.6	73.1	411	ADNOC
5229	122	121.9	85	373	Wang and Orr
5307	250	245.4	88	376.2	Jaubert et al.
5400	258	190	91.7	360	Meltzer
5414.7	209	259.9	86.4	365.5	ADNOC
5439.7	238	256	69.4	428.4	ADNOC
5452	238	217.3	81.4	391.5	Jaubert et al.
5464.7	266	202.3	77.7	403.6	ADNOC
5480.7	250	232.2	74.4	406.9	ADNOC
5495.5	239	199.9	81.7	391.1	Jaubert et al.
5496	222	191	76	400.7	Lee and Reitzel
5497	222	191	86.6	370	Lee and Reitzel
5500	200	214.9	87.7	367.5	ADNOC
5500	140	231.9	100	343	Sebastian and Lawrence
5514.7	266	202.3	90.3	363.8	ADNOC
5799	200	209	83.2	383	Firoozabadi Aziz
5800	200	209	83.2	383	Firoozabadi Aziz
5800	197	196	72.4	412.3	Glasø
5999	225	250	87.8	376	Firoozabadi Aziz
6000	225	250	90.3	363	Firoozabadi Aziz
6214.7	238	257.4	82.8	383.9	ADNOC
6298	225	250	100	343	Firoozabadi Aziz

Where,

MMP: minimum miscibility pressure, psia

T: Reservoir temperature, °F

MW C₇₊: Molecular weight of heptane plus fraction in crude oil, g/mol

C₁%: Methane percentage in the gas composition, %

T_{cR}: Critical gas temperature, R

7.4. Exploratory Data Analysis and Visualization

7.4.1. Data Exploration

After data collection and preparation, data processing is an essential step to check the quality and integrity of the database before building a reliable machine learning model. The exploratory data analysis (EDA) mainly consists of graphical and statistical techniques to summarize and describe the structure of the data, and consequently gain more insights and clues from the data [161]. Figure 7.1 shows a typical diagram for the data science workflow process.

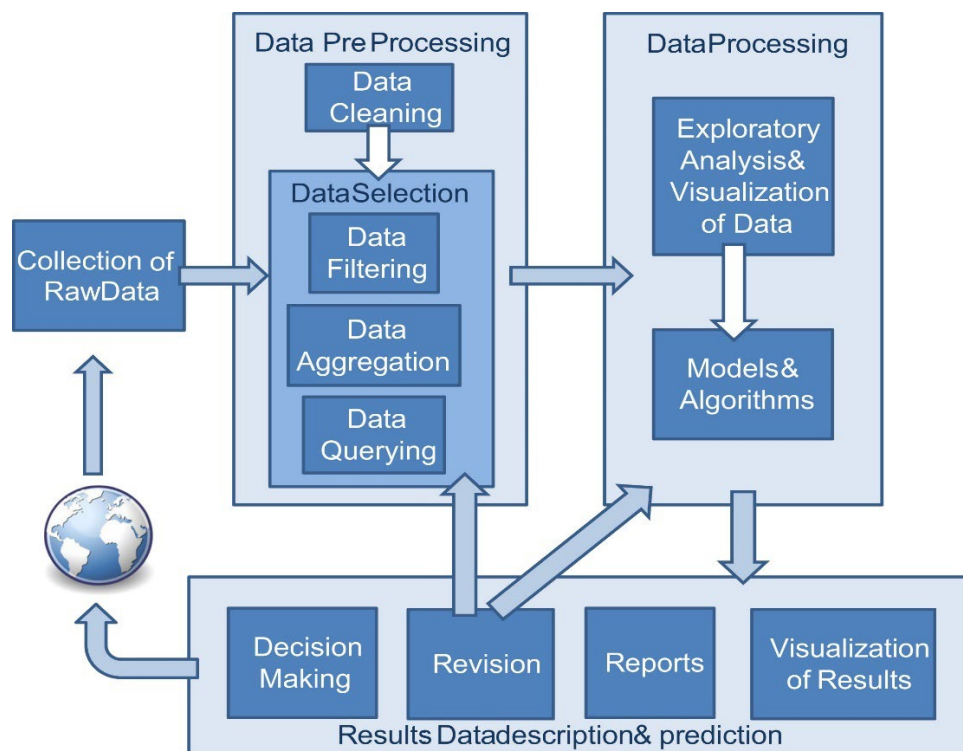

Figure 7.1 Flowchart of the data science process [161]

7.4.1.1. Statistical Data Overview

The spread of the MMP database was measured by calculating the main statistical properties of the data like minimum, maximum, mean, skewness, kurtosis, and standard deviation of the parameters. Table 7.3 shows a summary of the main statistical properties of the collected database.

Table 7.3 statistical summary of the collected MMP database.

Parameter	Min	Max	Average	Std dv	Skewness	kurtosis
MMP	2000.0	6298.0	4452.9	818.1	-0.58	0.68
T	105.0	285.0	225.2	40.5	-1.06	0.42
MW C₇₊	121.9	305.0	214.6	28.9	0.65	1.52
C₁%	10.3	100.0	75.2	14.6	-1.39	4.14
T_cR	343.0	545.0	407.3	41.4	0.813	0.73

It worth noting that skewness is a measure of the asymmetry of the data distribution, or in other words, how much a given distribution is different from the normal (symmetric) distribution. Where Kurtosis measures how different the tail of a given distribution from the normal distribution, so it is helpful to indicate how broad is the data and to identify the possible outliers in the database.

Based on the statistical data in Table 7.3, the database spread widely enough to build a robust model, as the studied miscibility pressure ranges from 2000 to 6298 psia, the methane percentage ranges between 10.3 and 100%, and the C₇₊ content in the crude oil ranges between 121.9 and 305 g/mol. The skewness value of the MMP data is -0.58 indicates that the distribution of the target parameter (MMP) is close to the normal distribution.

7.4.1.2. Graphical Data Overview

Graphical data visualization is a useful technique to confirm the spread of the data, in addition to determining the relationship between the input parameters (features) and the target parameter.

Histogram figures normally used to show the count, mode, variance, standard deviation, coefficient of deviation, skewness and kurtosis, which help to describe the data. Figure 7.2 below presents a histogram plot to show the distribution of the 153 MMP data points used in this study. The Figure confirms the normal distribution and the wide spread of the MMP data, where most of the points lies between 3,600 and 5,000 psi. Similarly, Figure 7.3 shows the methane percentage in the gas composition for the collect gas-oil MMP data. It is clear that methane content is over 60% in most of the MMP points, which is beneficial to achieve the objective of this research of gaining more understanding about the miscibility in methane-oil systems, and consequently propose informed solutions to reduce the MMP.

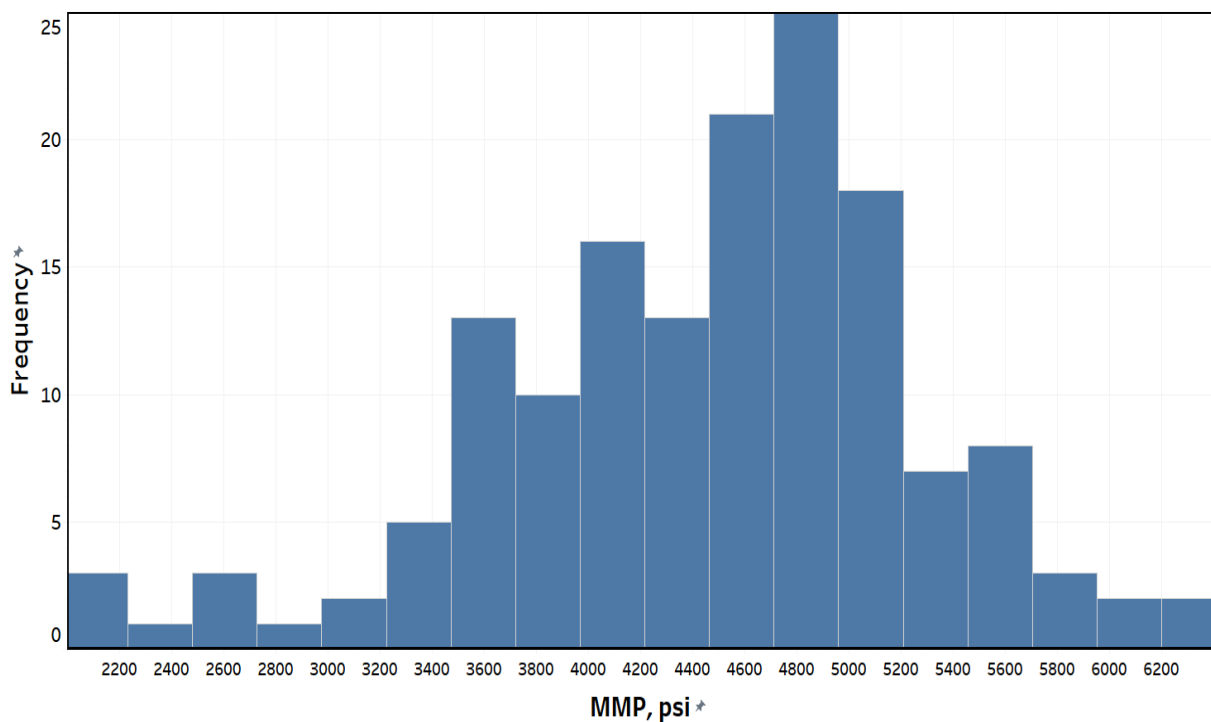

Figure 7.2 Histogram of the MMP data

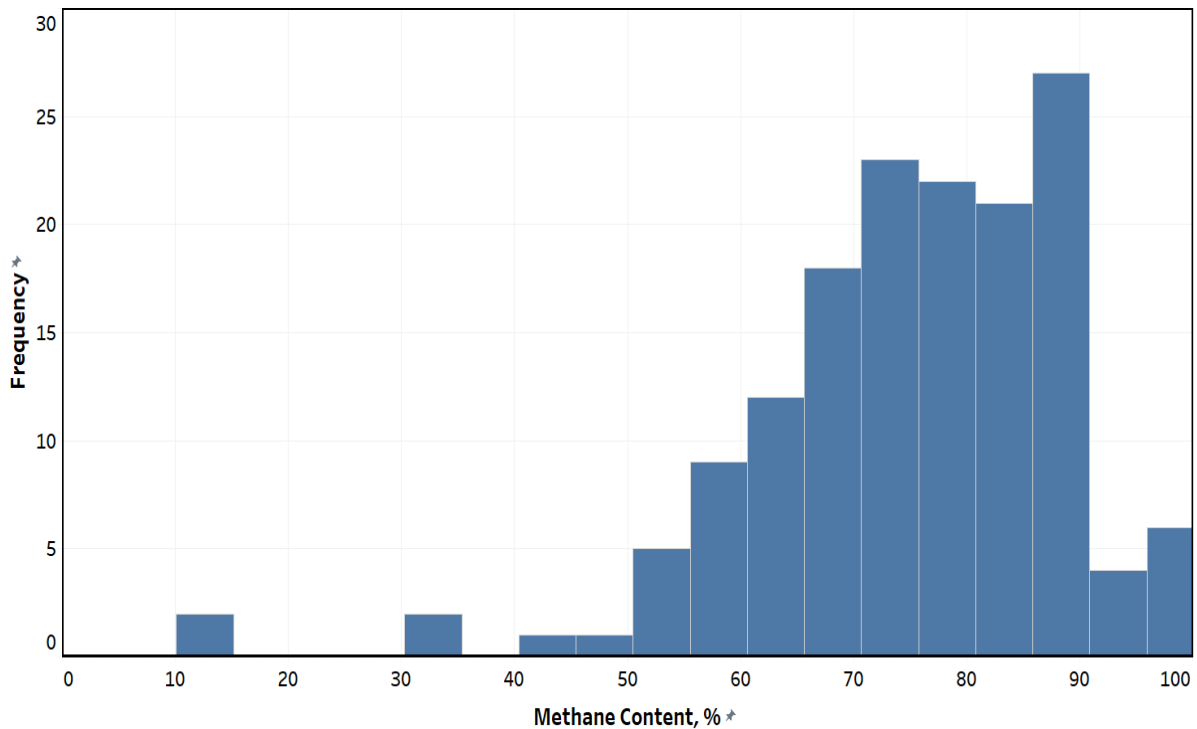

Figure 7.3 Histogram of the methane content in the gas

In this work, we used the Pearson correlation coefficient (PCC) method to determine the collinearity as it is a well validated method to determine the strength between the input parameters and the target parameter. In this method, the coefficient is considered strongly or weakly correlated if the absolute value of the Pearson coefficient is above or below a certain threshold, where a value ranges between -1 and 1 for perfectly negatively correlated variables and perfectly positively correlated respectively. A positive covariance between two variables indicates that these variables tend to be higher or lower at the same time. Negative covariance means inverse relationship. In other words, it shows the direction of the relationship between two variables, where the coefficient value shows the strength of the relationship.

The Pearson's correlation coefficient is calculated as the covariance of the two variables divided by the product of the standard deviation of each data sample in order to determine the correlation/movement between the two variables [162], as shown in the Equation 7.1. The PCC formula can also be calculated in terms of mean and expectation as per Equation 7.2.

$$\rho = \frac{COV(X,Y)}{\sigma_X\sigma_Y} \quad \text{Equation 7.1}$$

$$\rho = \frac{E[(X-\mu_X)*(Y-\mu_Y)]}{\sigma_X\sigma_Y} \quad \text{Equation 7.2}$$

Where,

ρ refers to Pearson correlation coefficient between X and Y data sets

σ_X is the standard deviation of X

σ_Y is the standard deviation of Y

E is the expectation

μ_X is the mean of X

μ_Y is the mean of Y

Figure 7.4 below shows Pearson correlation heatmap for the collected MMP database (153 data points). The Figure highlights the effect of each variable on the MMP. In particular, the heatmap demonstrates the strong positive correlation (0.67) between the MMP and the methane content in the gas, and the positive correlation (0.28) between MMP and the temperature. On contrast, the MMP of the hydrocarbon gas-oil system has a strong negative (-0.68) with the critical gas temperature. Where the effect of oil composition (MW C₇₊) was negligible on the MMP.

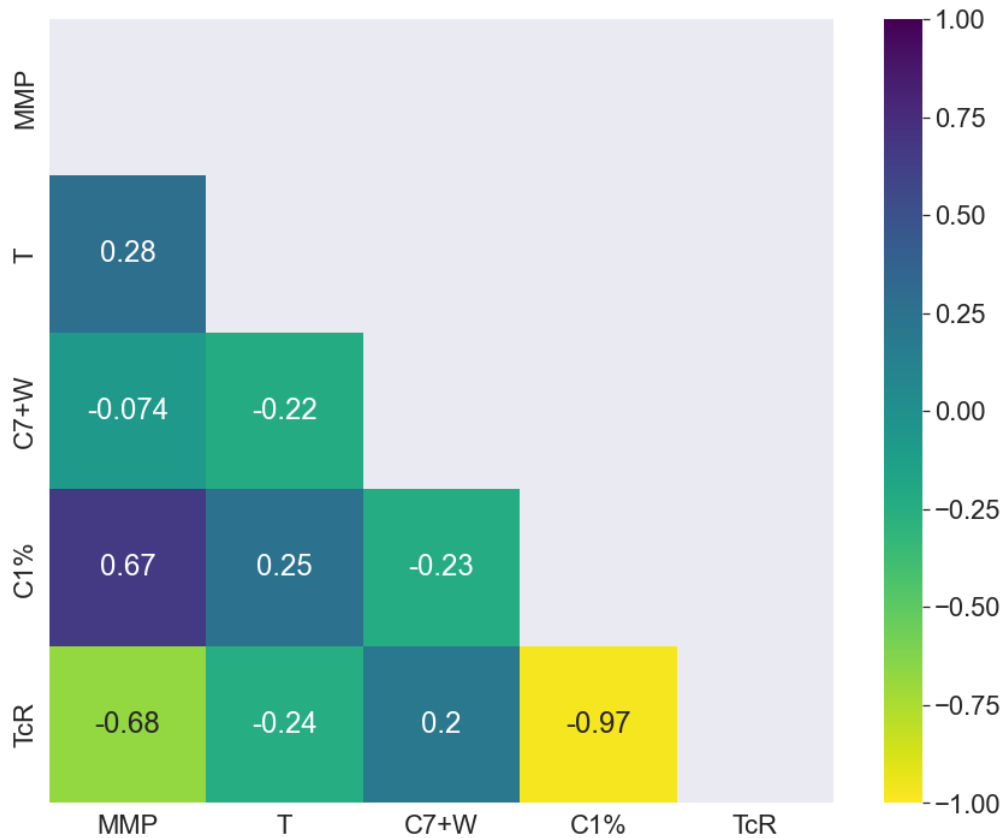

Figure 7.4 Pearson correlation heatmap for the collected MMP database (153 data points)

A similar heatmap was generated to further investigate the correlation between the parameters at higher methane content (mostly methane-oil system). As shown in Figure 7.5 below, the heatmap was generated using 61 data points and it indicates that the oil composition (represented by MW C_{7+}) is the only parameter that has an influence on the miscibility pressure when the methane content is higher than 80% in the total gas composition.

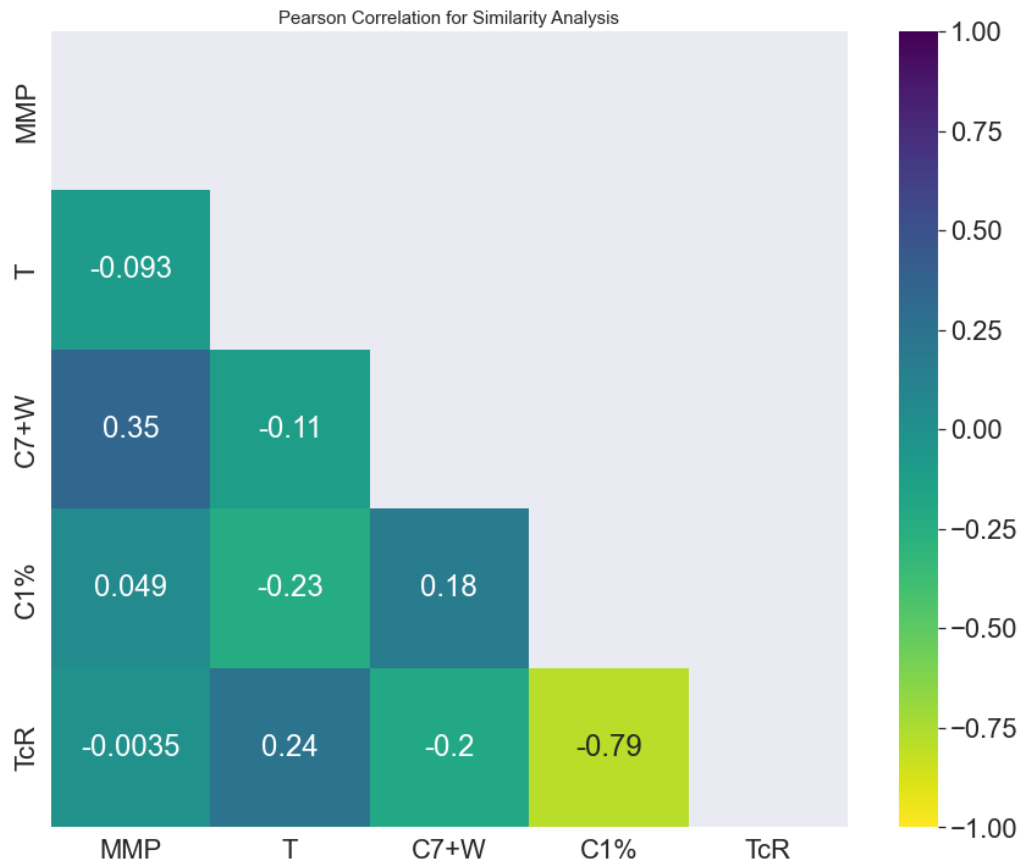

Figure 7.5 Pearson correlation heatmap for gas composition with methane content over 80% (61 data points)

Based on the mentioned above heatmaps, the controlling factors of the MMP in the gas-oil system varies depending on the methane percentage in the gas composition. In particular, for pure methane or gas composition with methane percentage over 80%, oil composition is the main controlling factor, and the temperature has only a minor or negligible effect on the miscibility. On contrast, when the methane percentage in the gas decreases, the impact of temperature and critical gas temperature increases gradually to be the dominant controlling factor on the MMP value. It worth noting that statistical and graphical analysis was calculated using Python libraries and functions.

7.4.2. Data Visualization

After statistical and graphical data analysis, data visualization is used as a powerful tool to further understand the underlying correlations between the parameters. Therefore, the target of this section is to gain in-depth understanding of the relationship between the involved parameters in the miscibility process through plotting the different variables in a scattered plotting format. Furthermore, in some figures, an additional variable is displayed by colour-coding one of the parameters to give more in-depth understanding. For data visualization in this work, we utilized Tableau software to plot the figures under different scenarios.

As per the preliminary statistical and graphical analysis, four main factors controlling the miscibility process in the gas-oil system, which are temperature, pressure, gas composition and oil composition. In this section, our target is to investigate the effect of each parameter (temperature, oil composition & gas composition) on the target parameter, which is the minimum miscibility pressure.

7.4.2.1. Effect of Temperature on MMP of Hydrocarbon Gas-Oil System

Figure 7.6 below shows the relationship between the system (reservoir) temperature and the MMP value in the collected hydrocarbon gas-oil system database. As the Figure indicates, the overall trend shows that the MMP tends to slightly increase with increasing the system temperature. On the other side, when the methane is dominant in the gas composition (more than 80%), increase temperature has negligible effect on the MMP as shown in Figure 7.7.

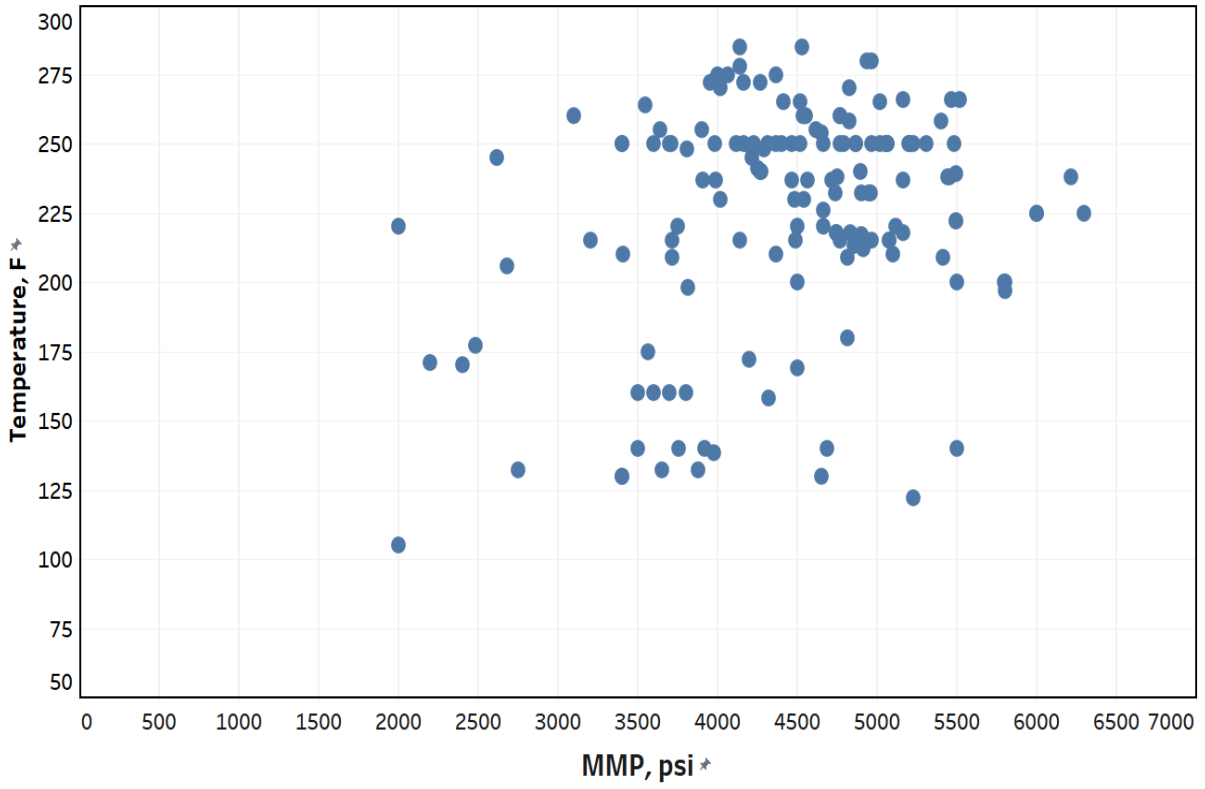

Figure 7.6 MMP vs Temperature relationship in hydrocarbon gas-oil system

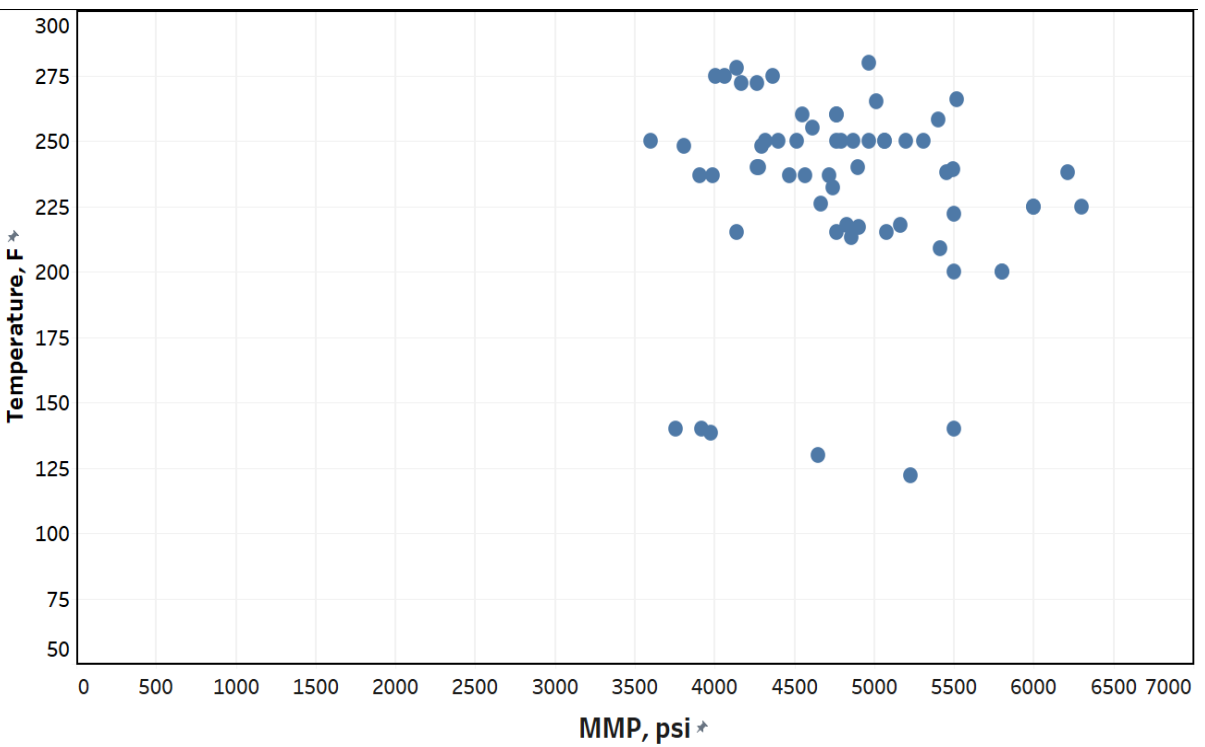

Figure 7.7 MMP vs Temperature relationship with methane content over 80%

7.4.2.2. Effect of Gas Composition on MMP of Hydrocarbon Gas-Oil System

In this work, methane percentage and critical gas temperature were used to investigate the effect of gas composition on the MMP value. Firstly, the MMP value is plotted against methane content in the hydrocarbon gas mixture. As shown in Figure 7.8, there is a clear relationship between the two parameters, as the MMP increases with increasing the methane content in the system.

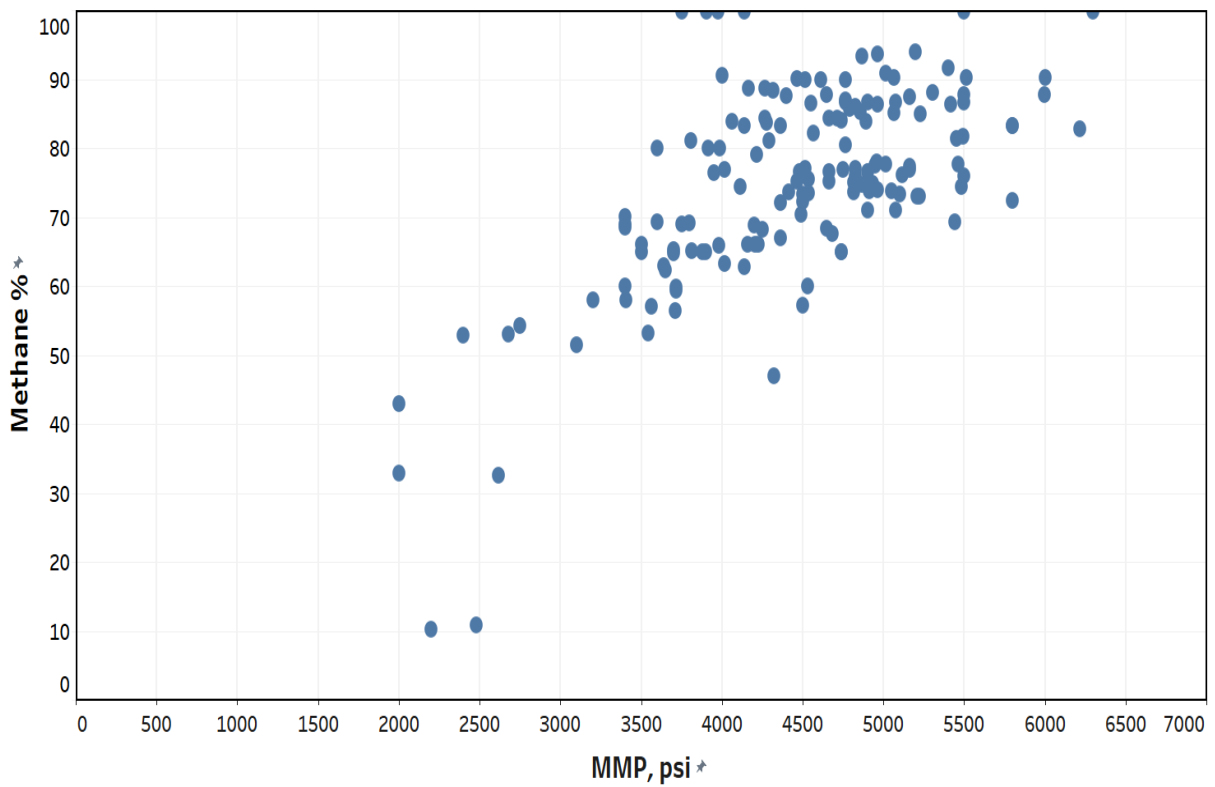

Figure 7.8 MMP vs methane content in hydrocarbon gas-oil system

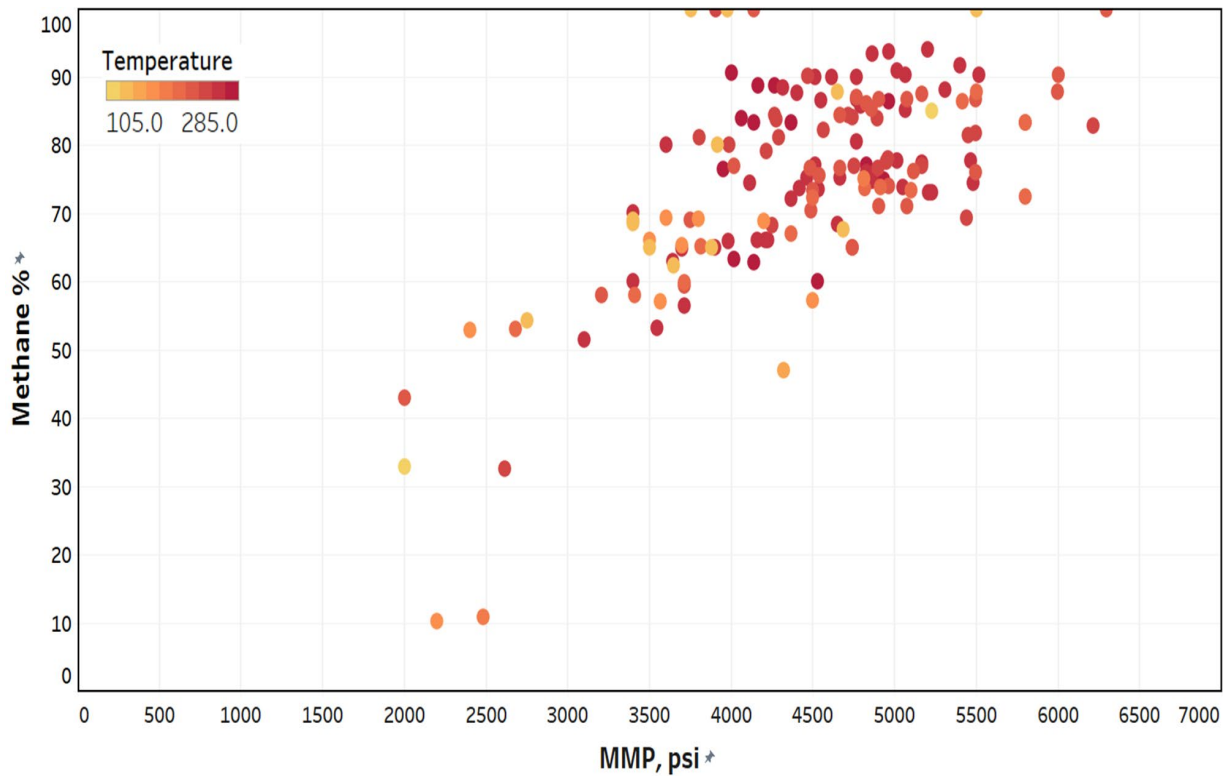

Figure 7.9 MMP vs methane content with temperature variation in hydrocarbon gas-oil system

In Figure 7.9, the same parameters were plotted with adding the temperature as a third variable. As the Figure indicates, the higher MMP value tends to be associated with higher methane content and higher temperature, where the higher temperature points represented by darker colour scale.

Secondly, critical gas temperature was found to be one of the main gas characteristics, which is defined as the temperature at the critical point where all properties of the liquid and the gas become identical [163]. In other words, the critical temperature for a substance is the temperature above which the gas cannot become liquid, regardless of the applied pressure. Typically, critical temperature is known for pure substances. However, for mixed hydrocarbon gases, the critical temperature is calculated through correlations using specific gas gravity or gas composition as input parameters [164].

Figure 7.10 below shows the relationship between the critical gas temperature and the MMP in the hydrocarbon gas-oil system. The Figure demonstrates the strong negative correlation

between MMP value and critical gas temperature, as the MMP increases with decreasing the critical gas temperature. It worth mentioning that the methane has much lower critical temperature (190 K) compared to other hydrocarbon gases and carbon dioxide (304 K) [100].

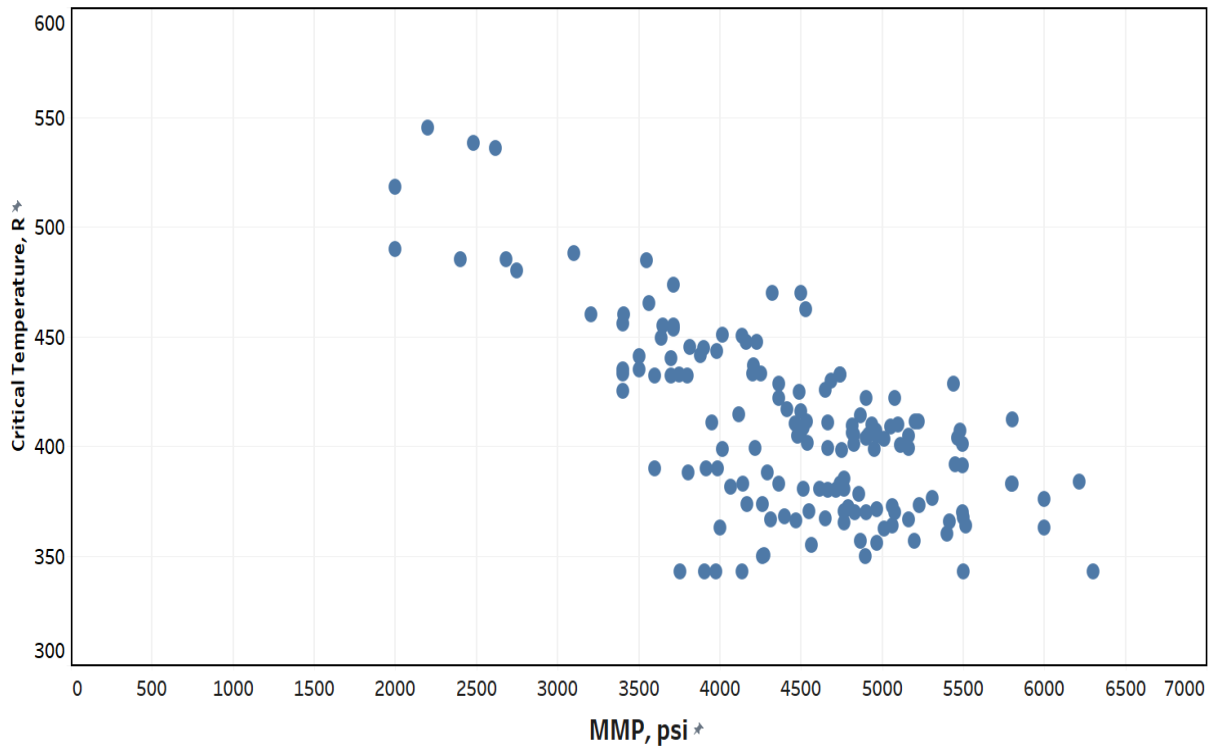

Figure 7.10 MMP vs critical gas temperature in hydrocarbon gas-oil system

7.4.2.3. Effect of Oil Composition on MMP of Hydrocarbon Gas-Oil System

The molecular weight of heptane plus (C_{7+}) in the crude oil was used to investigate the effect of oil composition on the MMP of the hydrocarbon gas-oil system. As shown in Figure 7.11 below, there is no clear trend or correlation between the MMP value and the crude oil composition. However, when the MMP versus oil composition was plotted only for methane or hydrocarbon gas with high methane content (over 80%), the positive correlation trend became clear, where the lower heptane plus content (lighter crude oil) results in lower miscibility pressure as shown in Figure 7.12. Therefore, similar to the observation from statistical and graphical data analysis, the graphical plotting of MMP versus crude oil

composition confirms that the MMP of the gas-oil system is more dependent on oil composition only in the case of high methane content (over 80%) or pure methane, while the oil composition effect becomes negligible when the content of the other hydrocarbon gases increases. Consequently, in the field applications, methane gas injection for enhanced oil recovery would be more effective in case of light crude oil condition.

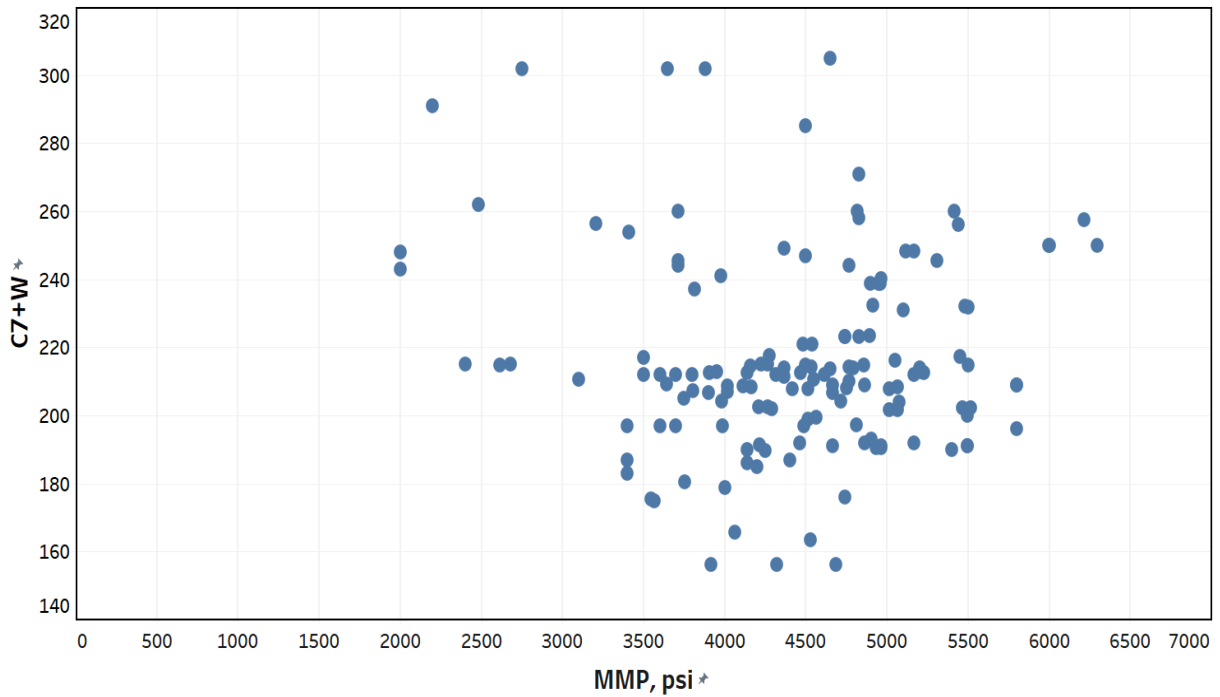

Figure 7.11 MMP vs oil composition in hydrocarbon gas-oil system

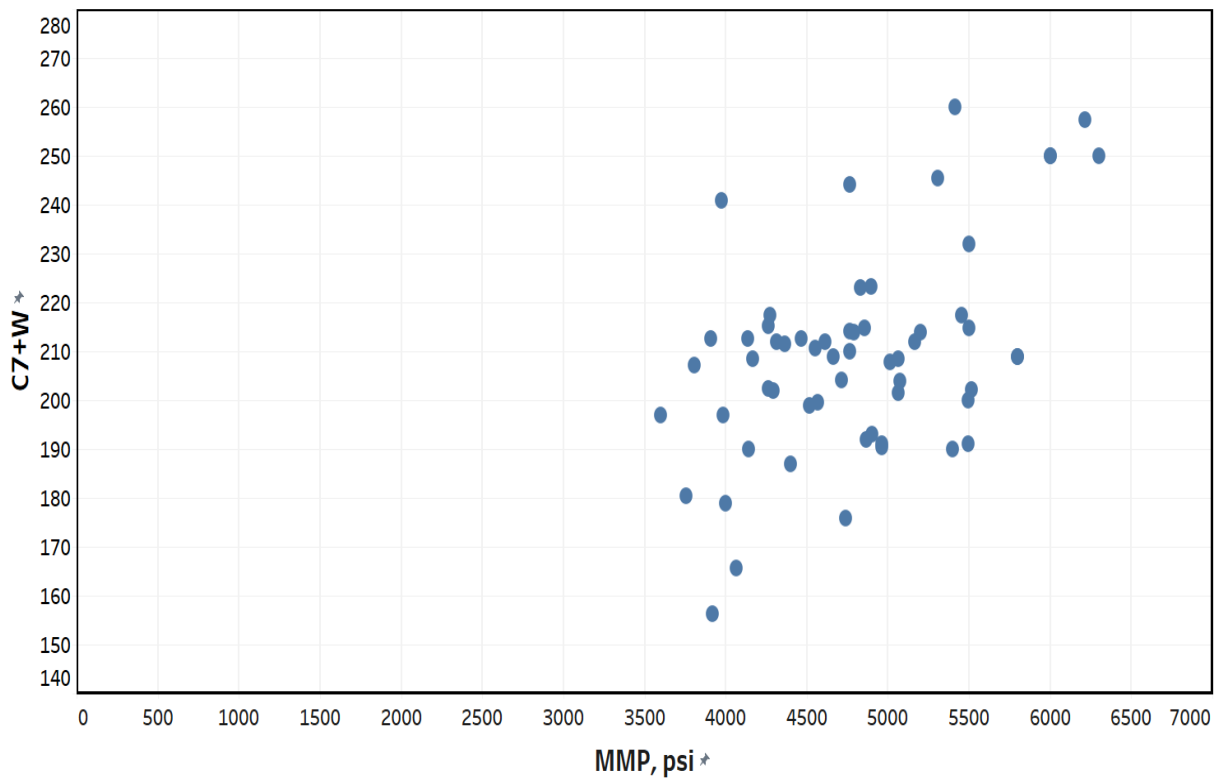

Figure 7.12 MMP vs oil composition with methane content over 80% (61 points)

7.5. Conclusion

In this chapter, a comprehensive database of hydrocarbon gas-oil MMP experimental data was collected and analysed to identify the main controlling factors of the minimum miscibility pressure. The results of the exploratory data analysis show that the MMP behaviour is highly dependent on the methane content in the gas composition. In particular, for pure methane or high methane content (over 80%), the miscibility is mainly controlled by vaporizing gas drive, where the main controlling factor influencing the miscibility is the molecular weight of heptane plus in the crude oil (MW C_{7+}). In other words, lighter crude oil composition results in lower MMP. However, as explained earlier using statistical and graphical analysis, the main controlling factors change in case of lower methane content to be gas composition and reservoir/system temperature, where the higher MMP values are associated with lower critical gas temperature and/or higher reservoir/system temperature.

In the field application, reservoir temperature and in-situ crude oil composition cannot be changed. Therefore, reducing MMP by modifying the injected gas composition, whether through using chemical additives or enriching by another gas, appears to be a practical solution to achieve the miscibility and consequently increase the oil recovery factor.

In chapters 4 – 6, we investigated the potential of MMP reduction in methane-oil system using chemical additives through IFT and coreflooding experiments for the first time. In this chapter, the main controlling factors were identified for methane-oil and hydrocarbon gas-oil systems based on statistical and graphical analysis of the collected comprehensive database. In the next chapter, we aim to utilize the insights from this chapter (controlling factors) to produce a machine learning model to predict the potential of reducing MMP by changing the gas composition (adding enriching gas) of the hydrocarbon gas-oil system.

Chapter 8 Machine Learning to Predict MMP in Hydrocarbon Gas-Oil Systems

8.1. Introduction

Application of artificial intelligence (AI) techniques is growing rapidly in the oil and gas industry to optimize the operational performance and to overcome the existing challenges [165]. Typically, a huge amount of data is generated in the oilfield on daily basis. Therefore, employing the advanced machine learning (ML) techniques to learn the historical data behaviour and consequently predict the expected future trend with high accuracy will certainly lead to improved performance, optimized cost, informed decisions, and potentially new insights from the data.

The objective of this chapter is to utilize the powerful tool of machine learning to produce a model that can accurately predict the minimum miscibility pressure (MMP) of a given hydrocarbon gas-oil system based on the main input parameters as identified in the previous chapter, which will consequently assist in predicting the potential MMP reduction through optimizing the gas injection composition. Moreover, machine learning models will help to cover the existing gap in the literature of having very limited studies related to hydrocarbon gas MMP prediction compared to published models to estimate the MMP in pure/impure CO₂-oil systems using different algorithms. Generally, machine learning techniques have several advantages, including the ability to detect the relationship between input and output parameters to model highly nonlinear systems.

Based on the presented data analysis in the previous chapter, MMP behaviour changes according to the dominant drive mechanism in the miscibility process, and it is highly dependent on the gas composition. Therefore, two separate machine learning models are

introduced in this chapter to accurately predict the MMP in pure/mostly methane-oil system and natural gas-oil system. In order to achieve this objective, firstly, we presented a summary of the existing studies and their limitations. Secondly, model selection and the used methodology are introduced, including a summarized description of the algorithms and evaluation methods. Afterwards, results and accuracy of the models are presented and discussed.

8.2. Literature Review

Several researchers reported the potential of applying machine learning (ML) techniques to predict the MMP of a given gas-oil system with higher accuracy compared to the published empirical correlations [166, 167]. However, most of the published work focused only on CO₂, and N₂ gas-oil systems, and there is a lack in similar studies for hydrocarbon gas system, which could be due to the limited availability of published hydrocarbon gas MMP data compared to CO₂, and N₂ gases. Therefore, in this section we present a summary of the few published machine learning studies to estimate the minimum miscibility pressure in the hydrocarbon gas-oil system.

Firstly, Birang et al. (2007) [144] used the artificial neural networks (ANN) technique to develop a model that estimates the MMP based on gas and oil composition inputs for vaporizing and condensing gas drives. The model was built based on 52 MMP data points, where training function updates weight and bias values according to Levenberg-Marquardt backpropagation optimization method. They used MATLAB software to utilize multilayer perceptron (MLP) algorithm in the process. The data was divided with a ratio of 80/20 for training and testing the model. The used input parameters are as shown in Table 8.1 below.

In another work, Khan et al. [168] tested three different ML algorithms to predict the MMP in hydrocarbon gas-oil system, they reported that the best results in the testing data was

obtained from the artificial neural network (ANN) algorithm, as it resulted in a 2.48% Mean Absolute Percentage Error (AAPE) compared to 3.43% and 9.79% in FN and SVM respectively. However, their correlation was developed based on 51 MMP data points with 44 points to train the model and only 7 points to test the accuracy, which could be considered as a very limited range. Input parameters for the model are mole fraction of C_1 , C_2 - C_6 , C_{2+} , molecular weight of C_{7+} and C_{2+} , and reservoir temperature, as shown in Table 8.1 below.

In a recent study, Fathinasab et al. [143] presented a new correlation based on Genetic Programming (GP) using 108 MMP data points based on a training/testing ratio of 80/20. They reported that the accuracy of the MMP estimation is within relative error of the 9.86%. The input parameters are reservoir temperature, critical gas temperature, molecular weight of C_{5+} components (oil), and the ratio of intermediate to volatile components in the gas composition. They concluded that injection gas composition, and the critical temperature of the injection gas has the strongest effect on MMP.

Table 8.1 below summarizes the published machine learning studies for MMP prediction in hydrocarbon gas-oil system, including the used ML algorithm, number of MMP data points, input parameters, and error percentage. As highlighted by the literature review, the existing studies demonstrate that there is a gap in MMP prediction studies in hydrocarbon-gas oil systems, in particular, the low number of points used in the tested ML models, in addition to the few numbers of tested algorithms in the published work. Therefore, the aim of this work is to provide a much-needed contribution to cover this gap in the literature by testing several efficient algorithms under a wider range of MMP data.

Table 8.1 summary of MMP prediction for hydrocarbon gas-oil system.

Reference	Algorithm	No. of Points	Inputs Parameters	Error%
Birang et al. (2007) [144]	MLP	52	-reservoir temperature -composition of C ₁ (oil) -composition of C ₂ -C ₆ and CO ₂ (oil) -MW C ₂ -C ₅ (oil) -MW C ₇₊ of crude oil -composition of C ₁ , C ₂ -C ₅ (gas) -molecular weight of C ₂ -C ₅ in the driving (gas)	
Khan et al. (2019) [168]	SVM FN ANN	51	-reservoir temperature -mole fraction of C ₁ , C ₂ -C ₆ , C ₂₊ , molecular weight of C ₇₊ and C ₂₊	
Fathinasab et al. (2020) [143]	Genetic Programming	108	-reservoir temperature -pseudocritical temperature of the injection gas -MW C ₅₊ oil components -intermediate (H ₂ S, CO ₂ , C ₂ -C ₄)- to-volatile (N ₂ and C ₁) ratio	9.86%

To achieve this goal, we utilized the database (153 MMP points) and findings (controlling factors) from the previous chapter to assist in building two separate machine learning models for pure/impure methane-oil system and hydrocarbon gas-oil system. In particular, different machine learning algorithms were tested to predict the MMP under a wide range of parameters and conditions. Afterwards, the results were plotted to measure the accuracy of the prediction compared to the actual values.

Two datasets were used to predict the gas-oil MMP based on the input parameters. Firstly, the complete database of 153 points were used for general hydrocarbon gas-oil MMP prediction. Afterwards, the main database was trimmed down to 61 points to include only the MMP points with the higher methane content which is equal to or greater than 80% of the total gas composition. The second dataset was developed to produce higher MMP prediction accuracy in pure/impure methane-oil systems.

8.3. Methodology

8.3.1. Model Selection

In this work, two models were tested with different hyper parameters to identify the optimum algorithm for MMP prediction in hydrocarbon gas-oil systems. In particular, multilayer perceptron (MLP) neural network and support vector regressor (SVR) were selected and trained to predict the MMP using the identified controlling factors in the previous chapter as input parameters. These models were selected as they resulted in high accuracy of MMP prediction in similar models for CO₂-oil system as reported by several researchers [169, 170]. The collected database was randomly divided into training and test data sets, where 80% of the data were used to train the model and the remaining 20% were used to test and validate the model performance.

The identified controlling factors are used as an input parameter (features) in the model to get a prediction of the output parameter (MMP). As previously indicated, the controlling factors are as follows:

- Molecular weight of heptane plus (MW C₇₊) in the oil to represent the oil composition parameter (g/mol)
- Critical gas temperature to represent the gas composition parameter (R)
- Methane (C₁) percentage in the gas composition (%)

- Temperature to represent the system/reservoir temperature condition (°F)

Multi-Layer Perceptron (MLP) Neural Network

Multi-Layer Perceptron (MLP) Neural Network is a common type of ANN which contains three layers, namely, input layer, hidden layer, and output layer. Where the hidden layer may contain one or more layers. This method uses dot products between inputs and weights, while the number of neurons in each method is optimized based on trial and error. Each neuron typically uses a nonlinear transformation called an activation function. Sigmoidal function and monotonic functions such as rectified linear unit (ReLU) are examples of the commonly used activation functions.

Training of the dataset is usually done through backpropagation (BP) for all layers using a certain number of iterations. Number of iterations needs to be selected carefully as the insufficient number of iterations does not allow enough time to the learning algorithm to detect the pattern of the inputs and outputs and, therefore the learning process is incomplete. While the model tends to be overtrained and not accurately predict the testing data if the number of iterations is much higher than the optimum. Similarly, optimization the number of hidden layers and the number of neurons/nodes in each layer is essential for optimizing the performance of the neural network. These critical parameters could be automatically optimized through using (hyper parameters). There are no guidelines on selected the parameters within each network, so it is mainly dependent on trial-and-error process. Figure 8.1 below shows a typical simple ANN schematic diagram.

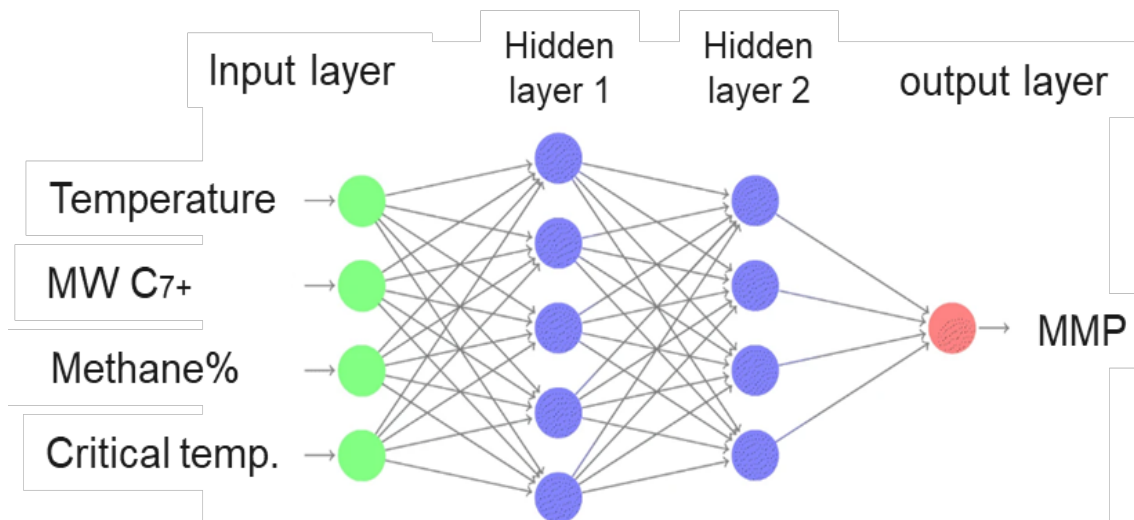

Figure 8.1 Schematic diagram of ANN [171]

Support Vector Regression (SVR)

Support Vector Regression (SVR) uses the same principle as support vector machine (SVM) [127], which has found many applications in various engineering fields [172]. SVR was originally adopted from machine learning SVM and it lies in the category of supervised learning methods and has the potential of being used for data interpretation, recognition of patterns and mathematical regression.

Support vector regression has an advantage of being accurate for solving the problem for nonlinear and small data samples while maintaining a good generalization ability [162]. The accuracy of the SVR algorithm is mainly dependent on the kernel functions and the hyperparameters (including error (ϵ), error penalty factor (C), number of iterations, and tolerance for stopping criteria (tol)), where the kernel function determine the properties of high-dimensional feature spaces and the hyperparameters determine the support vectors [173, 174]. Figure 8.2 below presents a schematic diagram of SVR algorithm.

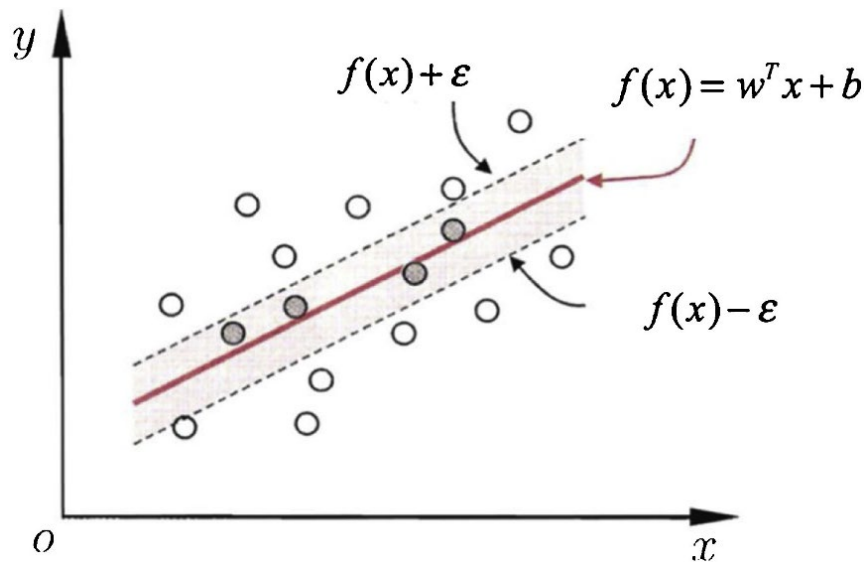

Figure 8.2 Schematic diagram of SVR [175]

The data of each individual input parameter has been normalized to values between 0 and 1 using the StandardScaler within Scikit-learn [176] pre-processing library in Python. The normalization step is important to avoid the possible bias due to the large difference in the scale of the units of each parameter. Afterwards, the network is being generated using the selected algorithm and the model is trained using the training dataset. Then the normalized parameters are reversed back to the standard scale and the regression is plotted.

8.3.2. Model Evaluation

Model performance can be evaluated using different graphical and statistical performance metrics. This step is essential to understand the model performance and assess its validity. In this work, regression plot was used as an initial graphical evaluation step, while R-squared (R^2) and root mean square error (RMSE) were used for the statistical evaluation.

First, in the regression plot or cross-plot technique, predicted values are plotted against the corresponding experimental values for different methods and a 45° straight line (unit slope line) is drawn on the plot which shows the perfect match. The closer the points to the unit slope line, the higher is the accuracy and prediction capability of the method. In this chapter,

the corresponding regression plot is presented below the results of each model to demonstrate a quick visual evaluation of the model accuracy.

For the statistical evaluation, two performance metrics were used as mentioned earlier. First, root mean square error (RMSE) which calculates the prediction performance based on the standard deviation of the residuals (prediction errors), as shown in Equation 8.1 below,

$$\text{RMSE} = \sqrt{\frac{1}{n} \sum_{i=1}^n (y_i^* - y_i)^2} \quad \text{Equation 8.1}$$

Where n represents the number of data points, y_i^* represents predicted value, and y_i represents the actual measured value. A benefit of using RMSE is that the metric it produces is on the same scale as the unit being predicted.

Second, R-square (R^2), which is also known as coefficient of determination, is calculated based on the proportion of the variation in the dependent variable that is predictable from the independent variable, as presented in Equation 8.2 below. Typically, the value of R^2 ranges between $-\infty$ and 1.

$$R^2 = 1 - \frac{\text{sum of squares of residuals}}{\text{total sum of squares}} \quad \text{Equation 8.2}$$

8.4. Results and Discussion

8.4.1. MMP Model Results for Hydrocarbon Gas-Oil System

First, the training dataset was used to teach and develop the machine learning model, then the testing dataset (unseen data) was used for the model validation process. Afterwards, the overall model performance using the complete dataset was plotted and the performance metrics were calculated. The cross-plot (regression plot) is also presented under each figure to visualize the model performance.

The performance of MLP neural network algorithm to predict the MMP was evaluated first. Figure 8.3 below shows the predicted MMP plotted against the actual MMP values during the training process. The regression plot also demonstrates the calculated performance metrics. As the results indicate, the MLP model is capable of predicting the MMP with accuracy of 95.9% (R^2 of 0.959) which means that the explained variance by the model was 95.9%.

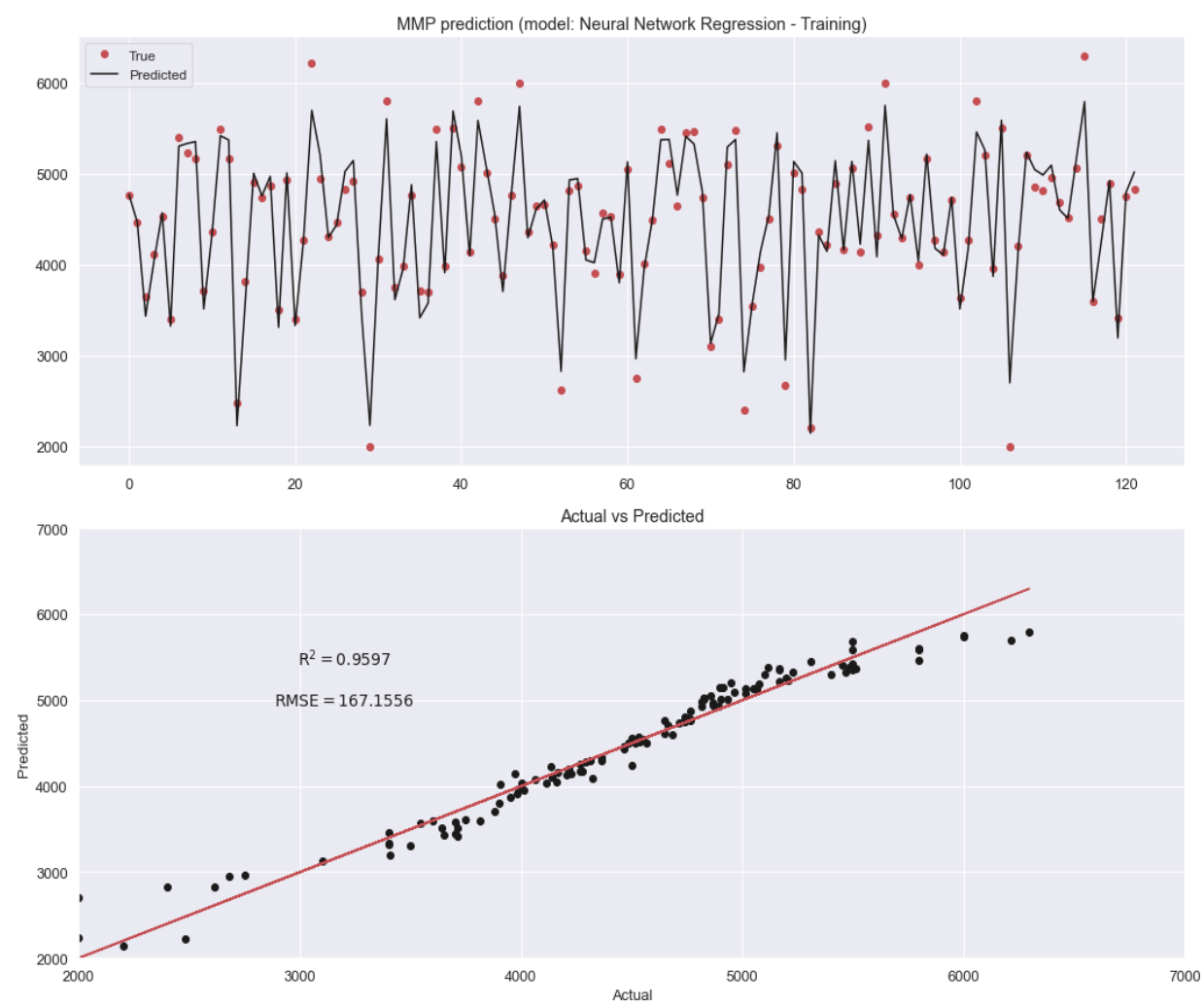

Figure 8.3 MLP model performance in the training stage for MMP prediction in hydrocarbon-gas oil system

After training the model, the testing dataset, which is 20% of the main MMP dataset, was used to validate the model performance. As shown in Figure 8.4 below, the model was able to predict the MMP with an accuracy of 95.4%.

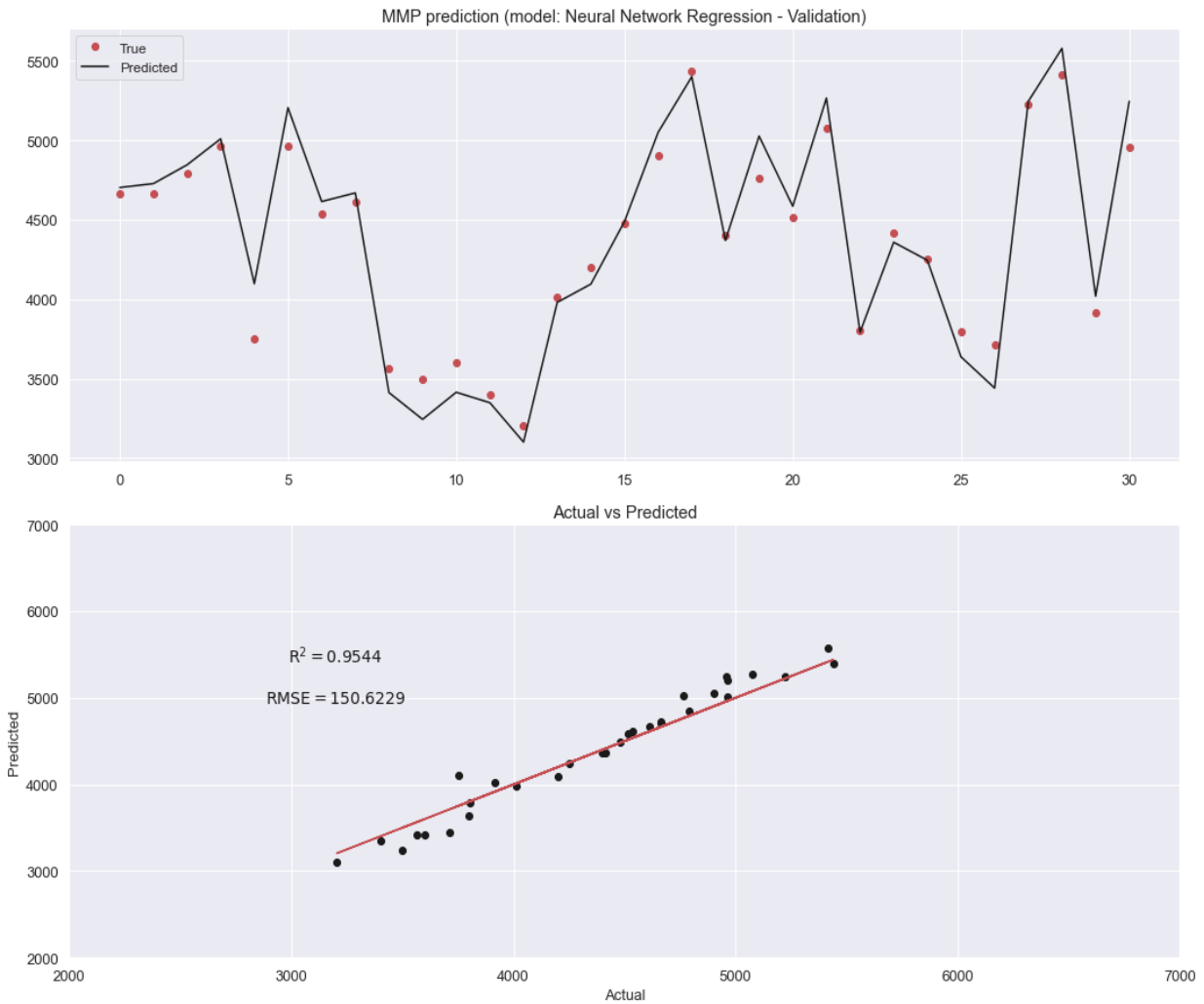

Figure 8.4 MLP model performance in the validation stage for MMP prediction in hydrocarbon-gas oil system

After getting acceptable results in the training and validation steps, the overall performance of the MLP model is calculated and presented in Figure 8.5 below. As the results indicate, the overall model accuracy is 95.8%. The regression plot highlights the overall prediction trend, which demonstrates higher prediction accuracy in the middle range of the MMP where the predicted MMP points are closer to the straight line of perfect fit. On contrast, the accuracy seems to be lower on both ends of the plot, which could be due to having less number of points to train the model on each side.

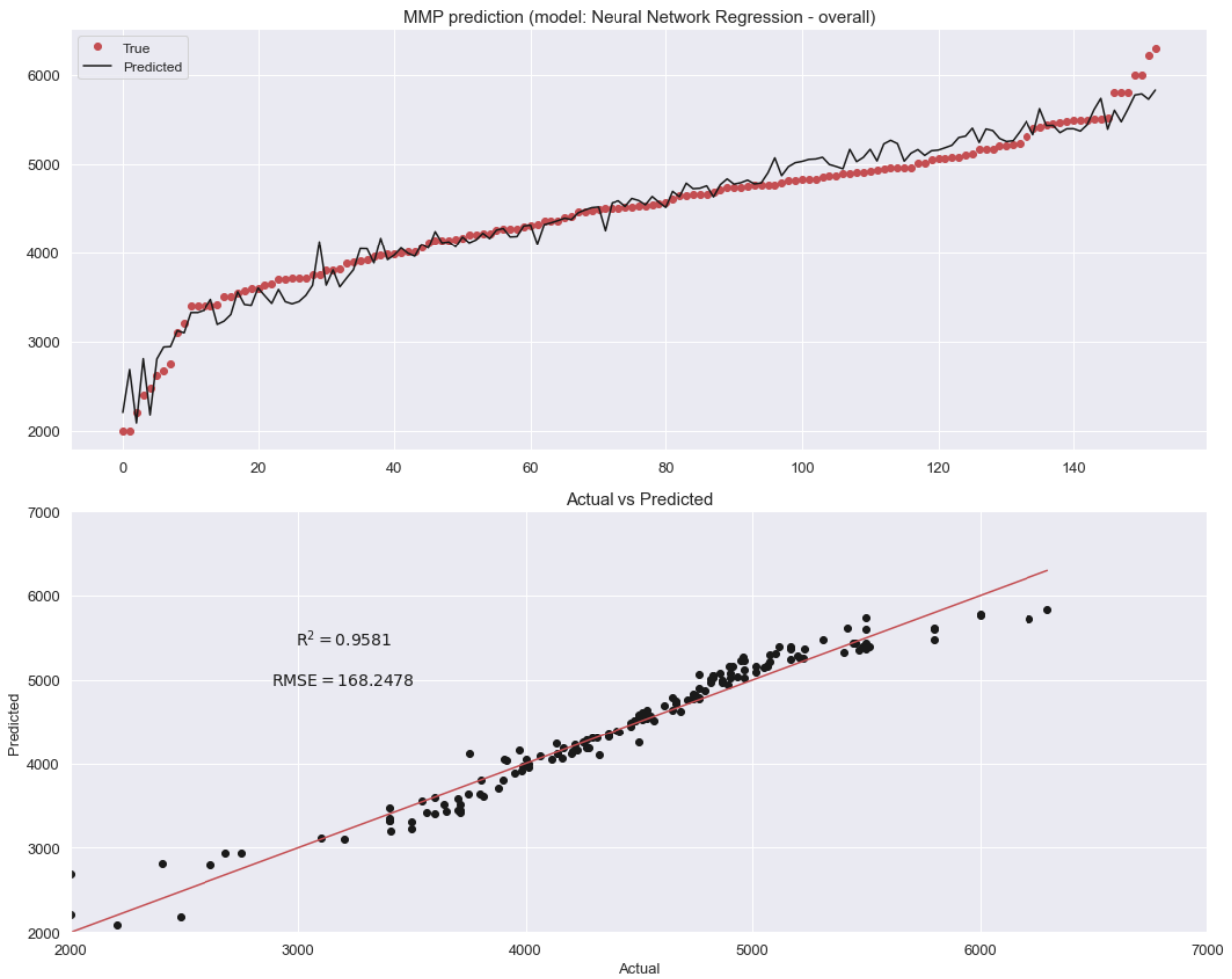

Figure 8.5 Overall MLP model performance for MMP prediction in hydrocarbon-gas oil system

Similarly, the performance of support vector regression (SVR) algorithm was examined using the same procedure and dataset. As shown in Figure 8.6 below, the model was capable of predicting the MMP with an accuracy of 96.2% during the training process, which is slightly higher compared to MLP which had 95.9% accuracy at the same stage.

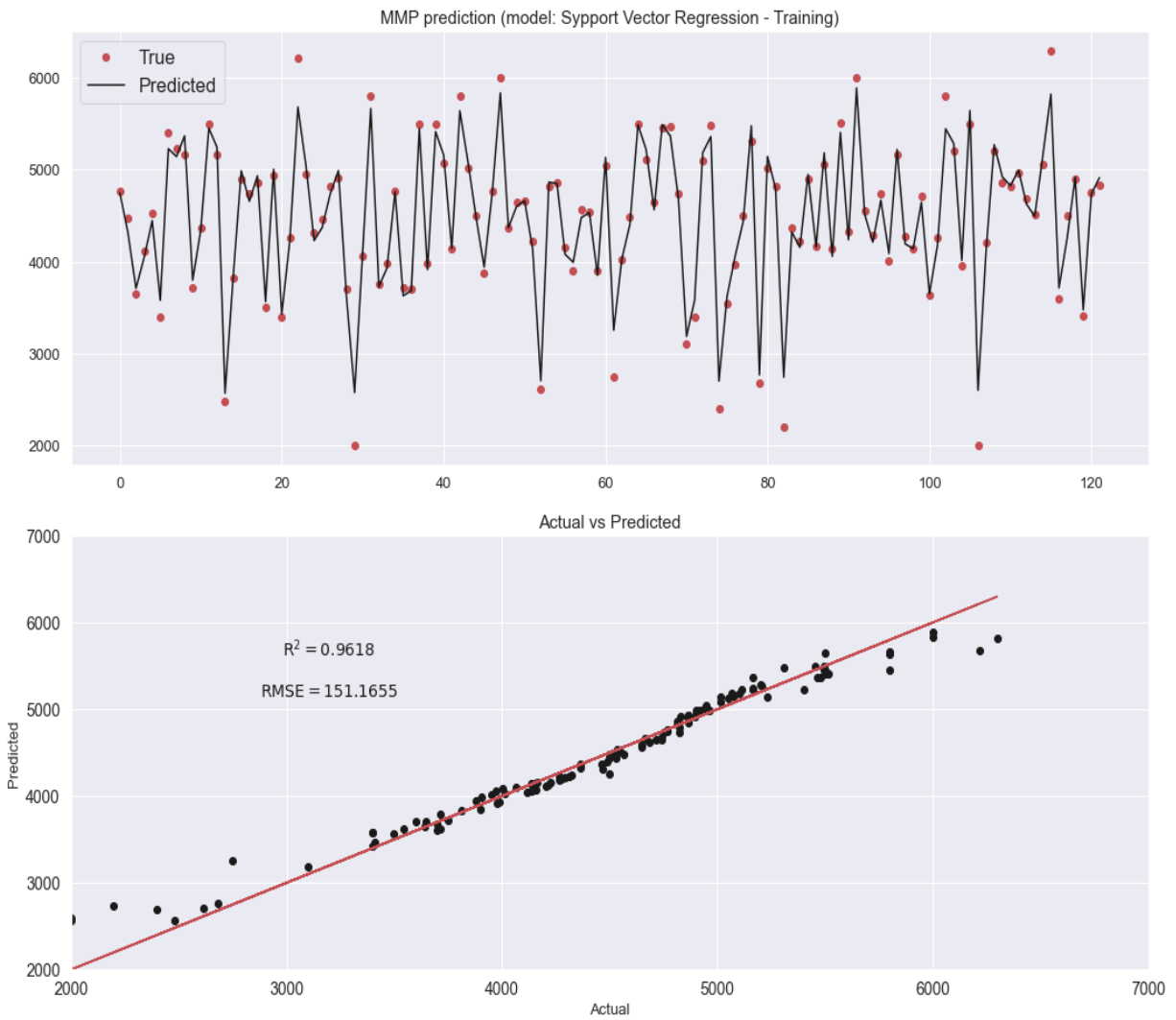

Figure 8.6 SVR model performance in the training stage for MMP prediction in hydrocarbon-gas oil system

After training the model, the prediction performance was validated using the unseen data (testing data set). As shown in Figure 8.7 below, the model was able to predict the MMP with an accuracy of 94.6%.

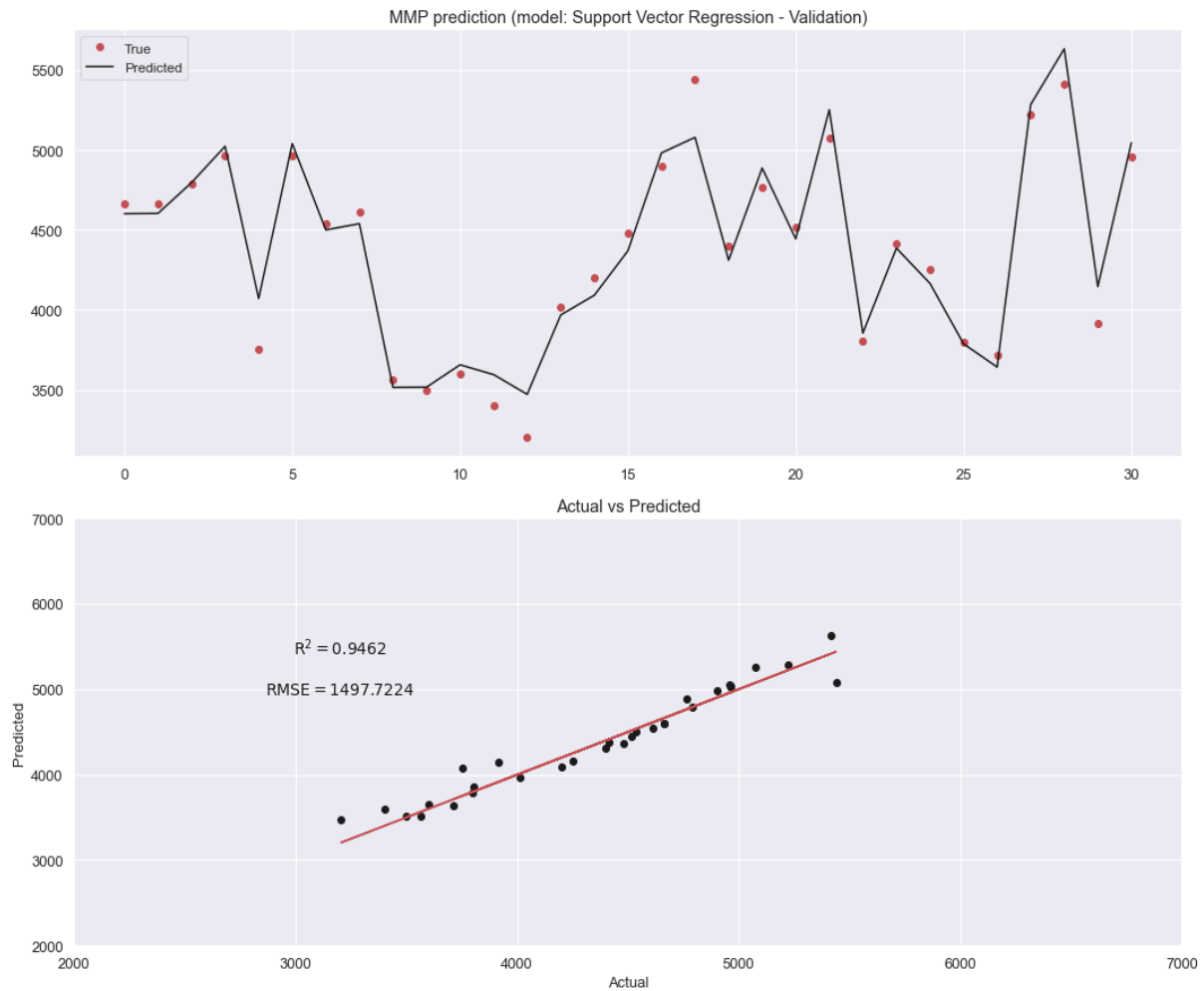

Figure 8.7 SVR model performance in the validation stage for MMP prediction in hydrocarbon-gas oil system

After getting acceptable results in the training and validation steps, the overall performance of the SVR model is presented in Figure 8.8 below. As the results indicate, the overall model accuracy is 95.8%, which is almost identical performance compared to the MLP model. Similarly, the regression plot highlights the overall prediction trend, which demonstrates higher prediction accuracy in the middle range of the MMP and lower prediction accuracy on both ends of the plot, which could be due to having a smaller number of points to train the model on each side.

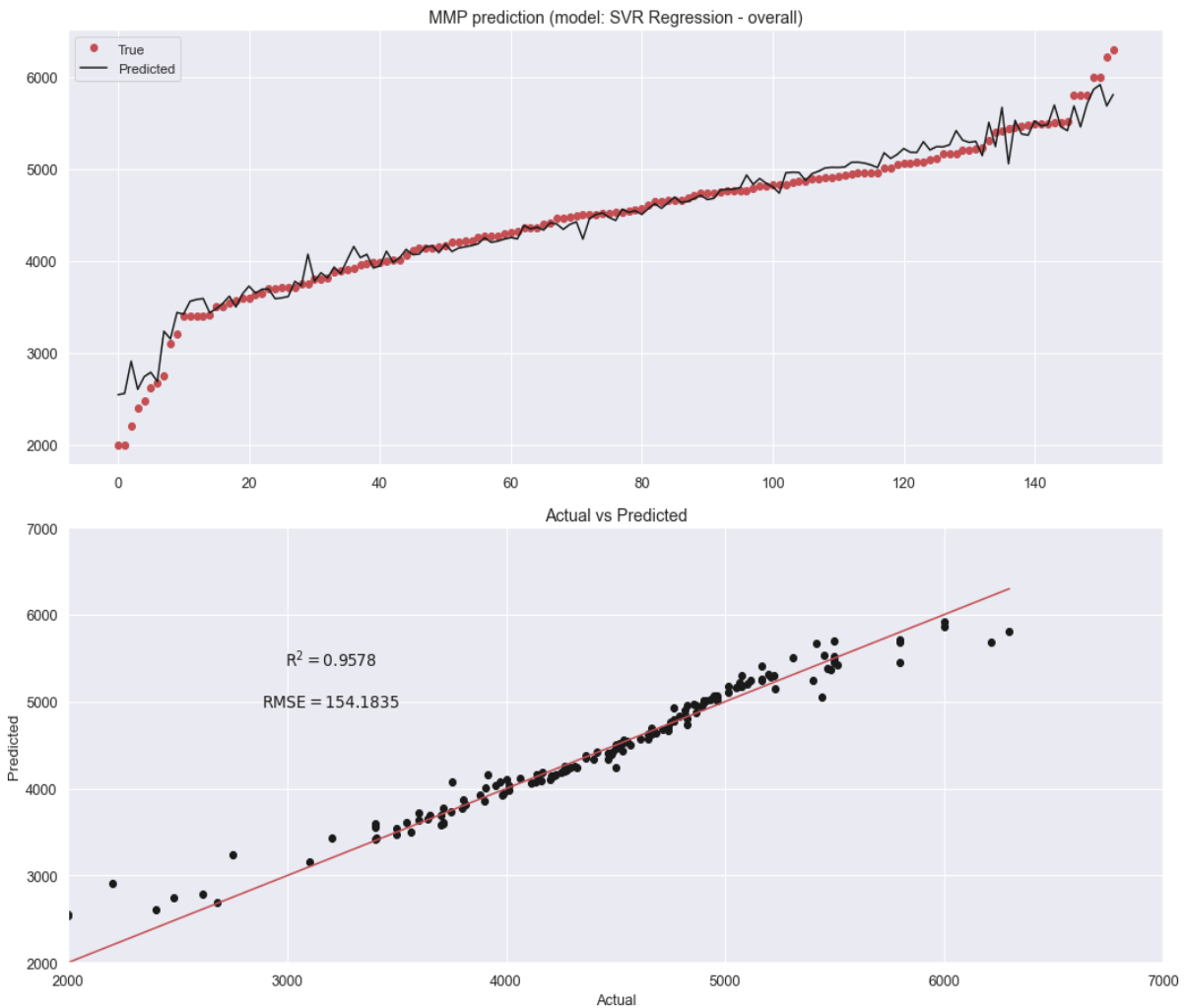

Figure 8.8 Overall SVR model performance for MMP prediction in hydrocarbon-gas oil system

8.4.2. MMP Model Results for Methane-Oil System

The collected database was reduced to 61 MMP point only to develop and represent the methane-oil system model, where all the selected data points have a methane content of 80% or more in the gas composition. As mentioned earlier in chapter 7, unlike the hydrocarbon gas-oil system, the main controlling factor in case of methane-oil system is the oil composition.

Firstly, MLP neural network algorithm was utilized to predict MMP using the updated methane MMP dataset. As shown in Figure 8.9 below, the results demonstrate high prediction

accuracy during the training process, where the R^2 was 0.98, corresponding to 98.4% MMP prediction accuracy during the training process.

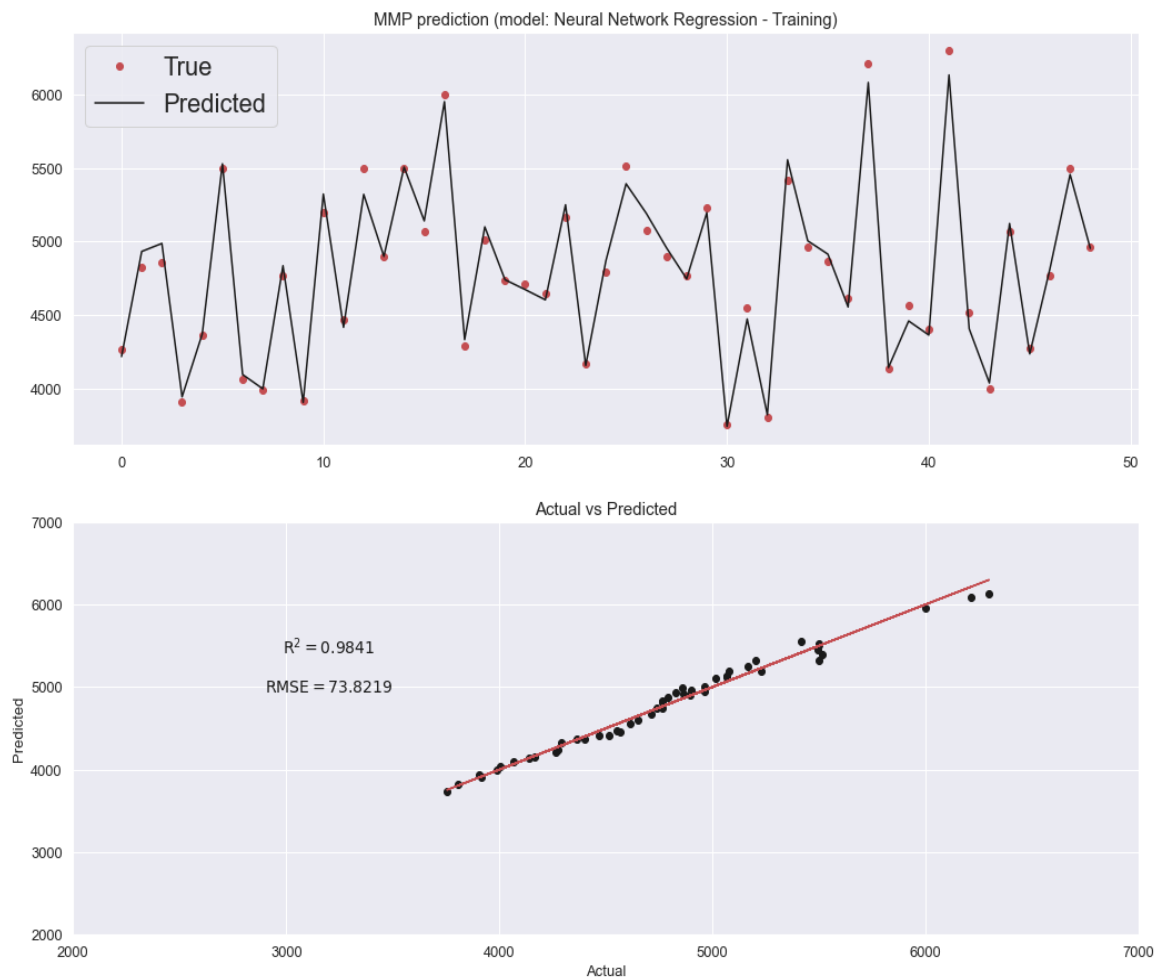

Figure 8.9 MLP model performance in the training stage for MMP prediction in methane-gas oil system

The model performance was similarly evaluated in the validation step using the unseen data (testing dataset). As shown in Figure 8.10 below, the prediction accuracy dropped to 94.8%, which is considered reasonable given the reduced number of training data.

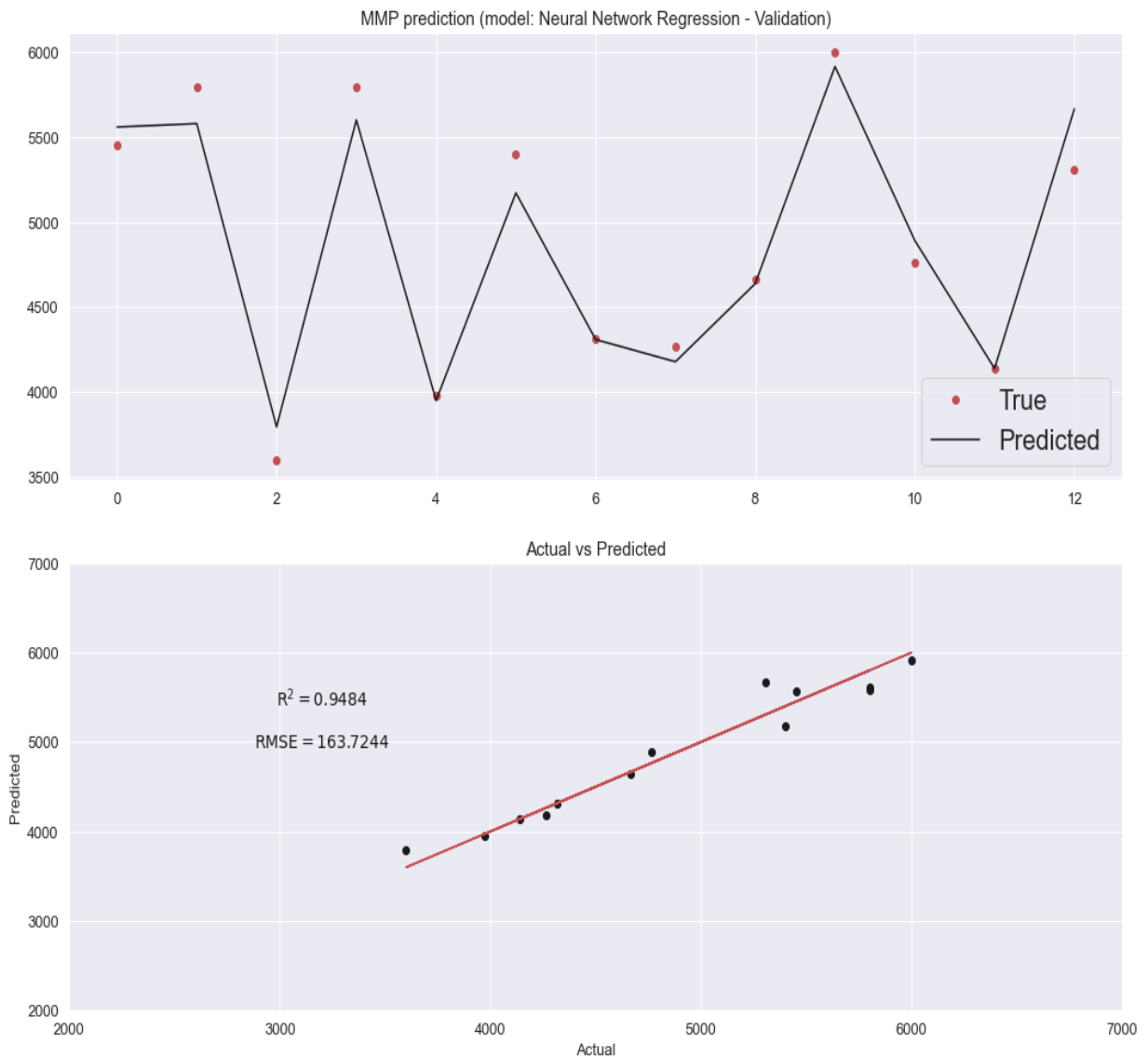

Figure 8.10 MLP model performance in the validation stage for MMP prediction in methane-gas oil system

After getting acceptable results in the training and validation steps, the overall performance of the MLP model is presented in Figure 8.11 below. As the results indicate, the overall model accuracy is 96.6%. The initial visual observation from the regression plot indicates an overall accurate prediction trend under 5200 psi, and a slightly lower prediction accuracy at higher pressure (MMP more than 5200 psi), which could be due to having fewer number of MMP points to train the model at higher pressure condition.

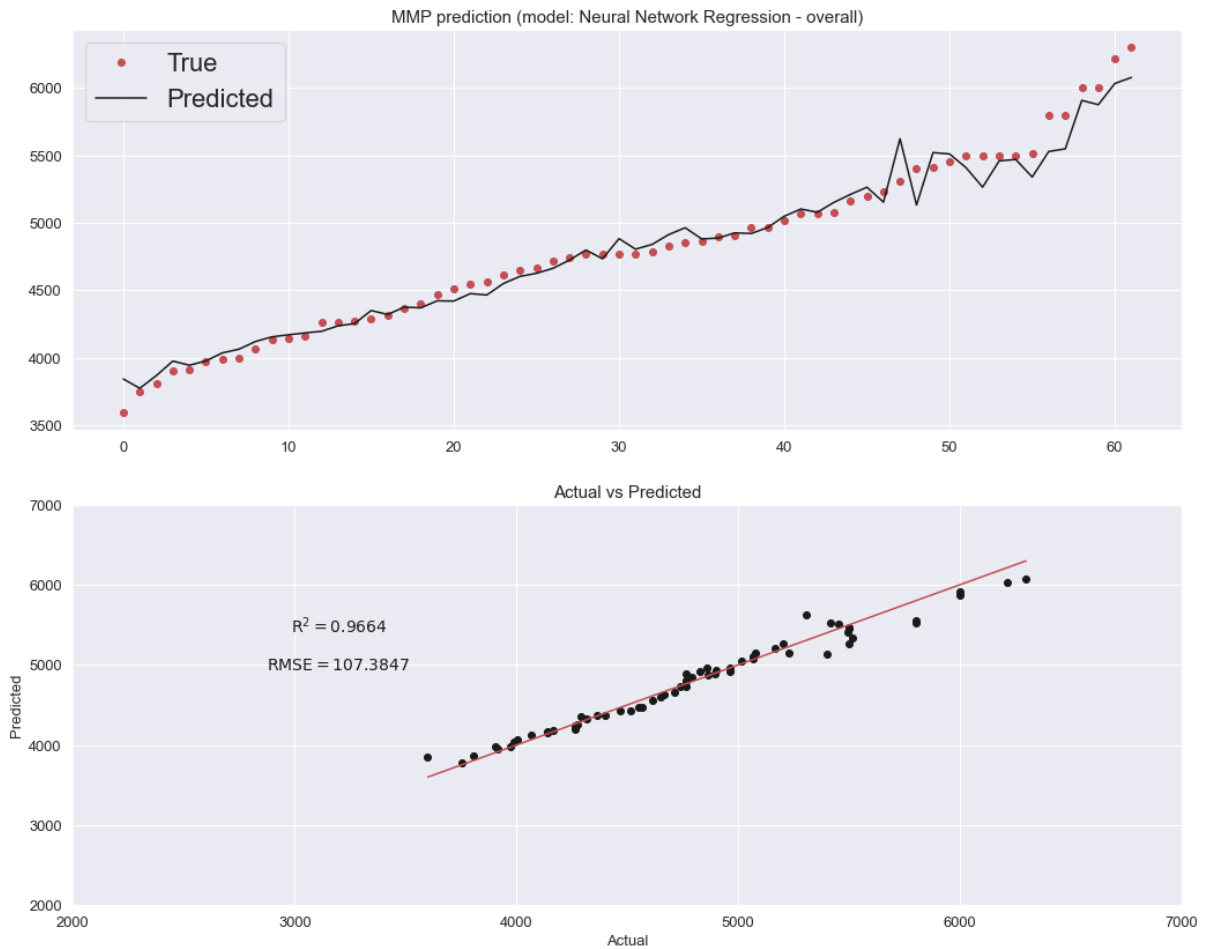

Figure 8.11 Overall MLP model performance for MMP prediction in methane-gas oil system

Similarly, the performance of support vector regression (SVR) algorithm was examined using the same procedure and dataset. As shown in Figure 8.12 below, the model was capable of predicting the MMP with an accuracy of 95.1% during the training process, which is slightly lower compared to MLP which had 98.4% accuracy at the same stage.

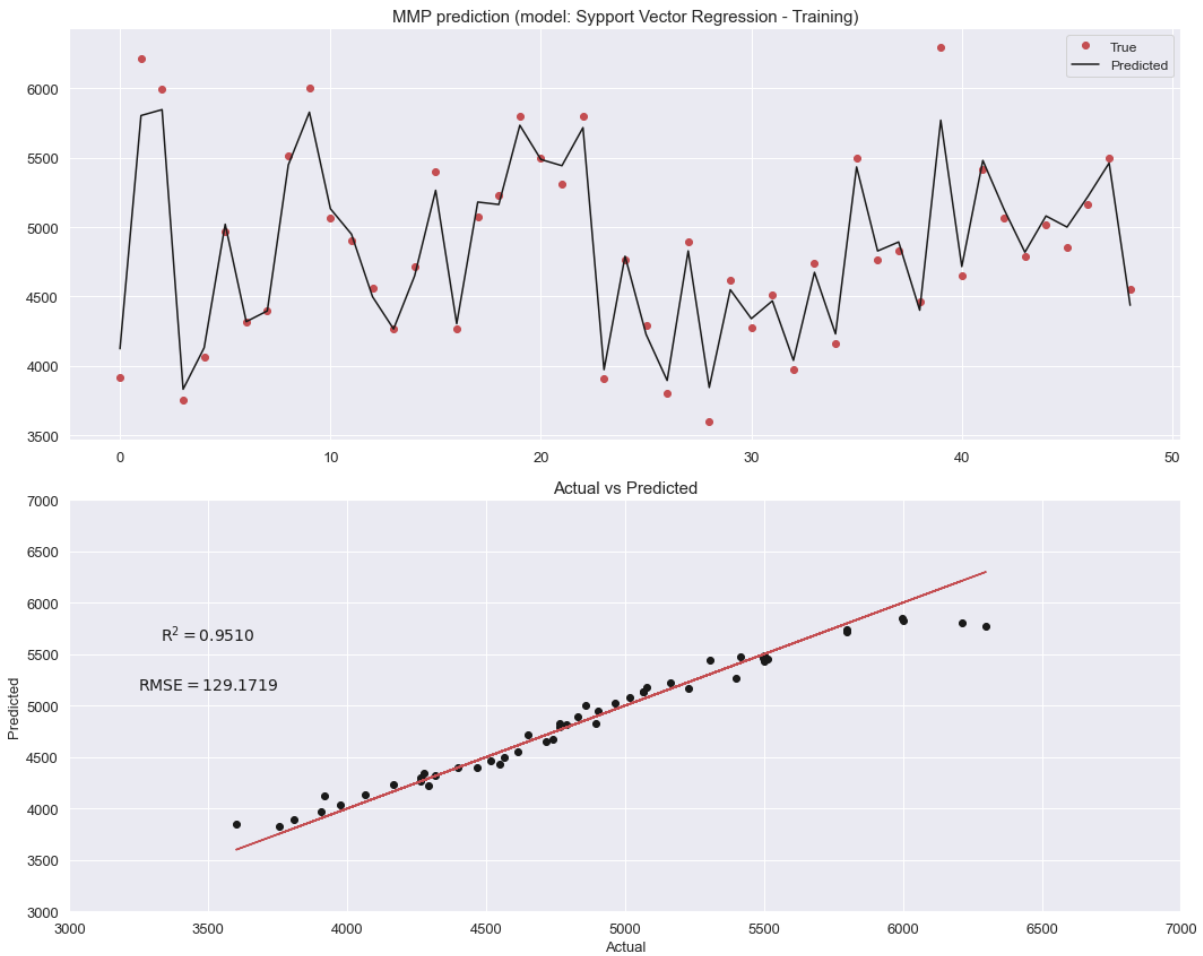

Figure 8.12 SVR model performance in the training stage for MMP prediction in methane-gas oil system

After training the model, the prediction performance was validated using the unseen data (testing data set). As shown in Figure 8.13 below, the model was able to predict the MMP with an accuracy of 94%.

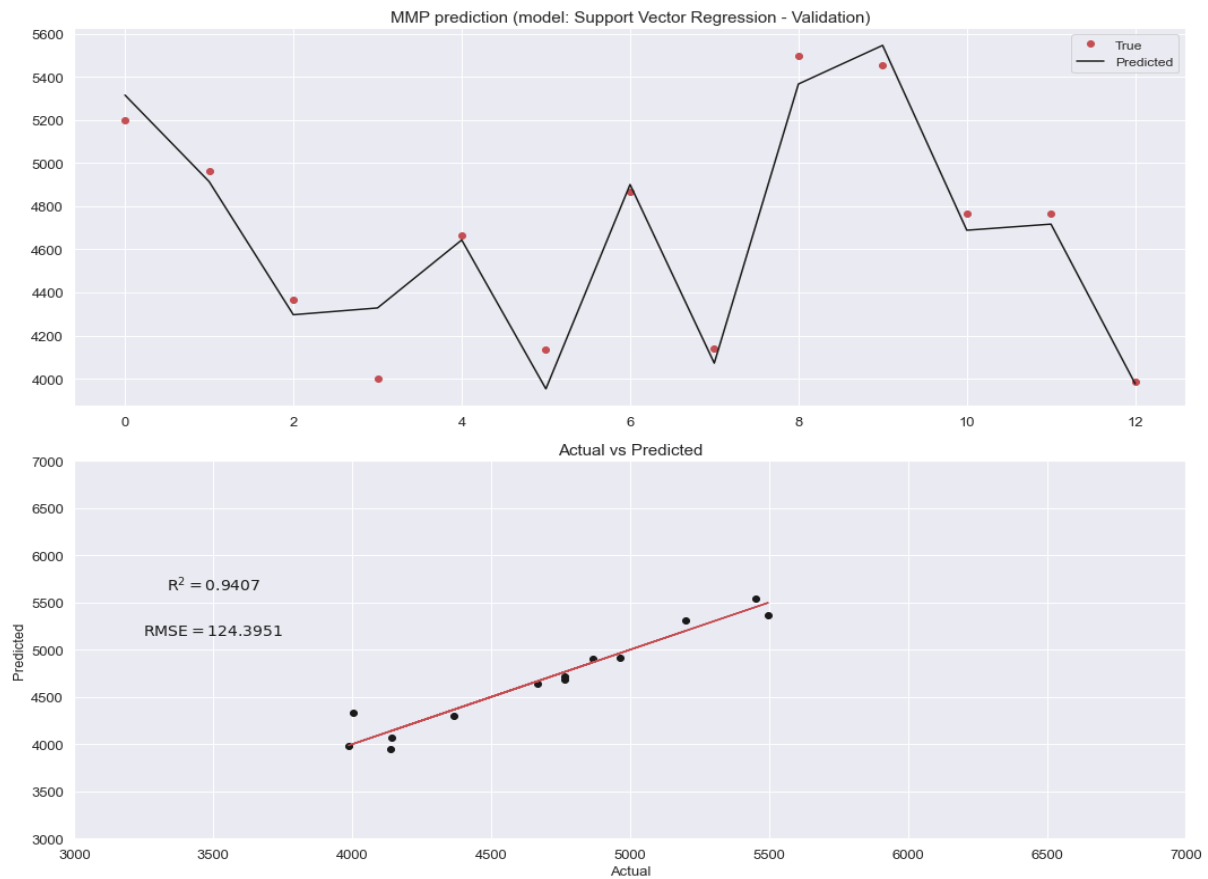

Figure 8.13 SVR model performance in the validation stage for MMP prediction in methane-gas oil system

After getting acceptable results in the training and validation steps, the overall performance of the SVR model was calculated and presented in Figure 8.14 below. As the results indicate, the overall model accuracy is 94.3%, which is slightly lower than the MLP neural network model which had an overall prediction accuracy of 96.6%. As observed from the regression plot, the model results in overall accurate prediction trend when the MMP value is under 5200 psi. However, the prediction accuracy tends to decrease at higher pressure (MMP more than 5200 psi), which could be due to having fewer number of MMP points to train the model at higher pressure condition.

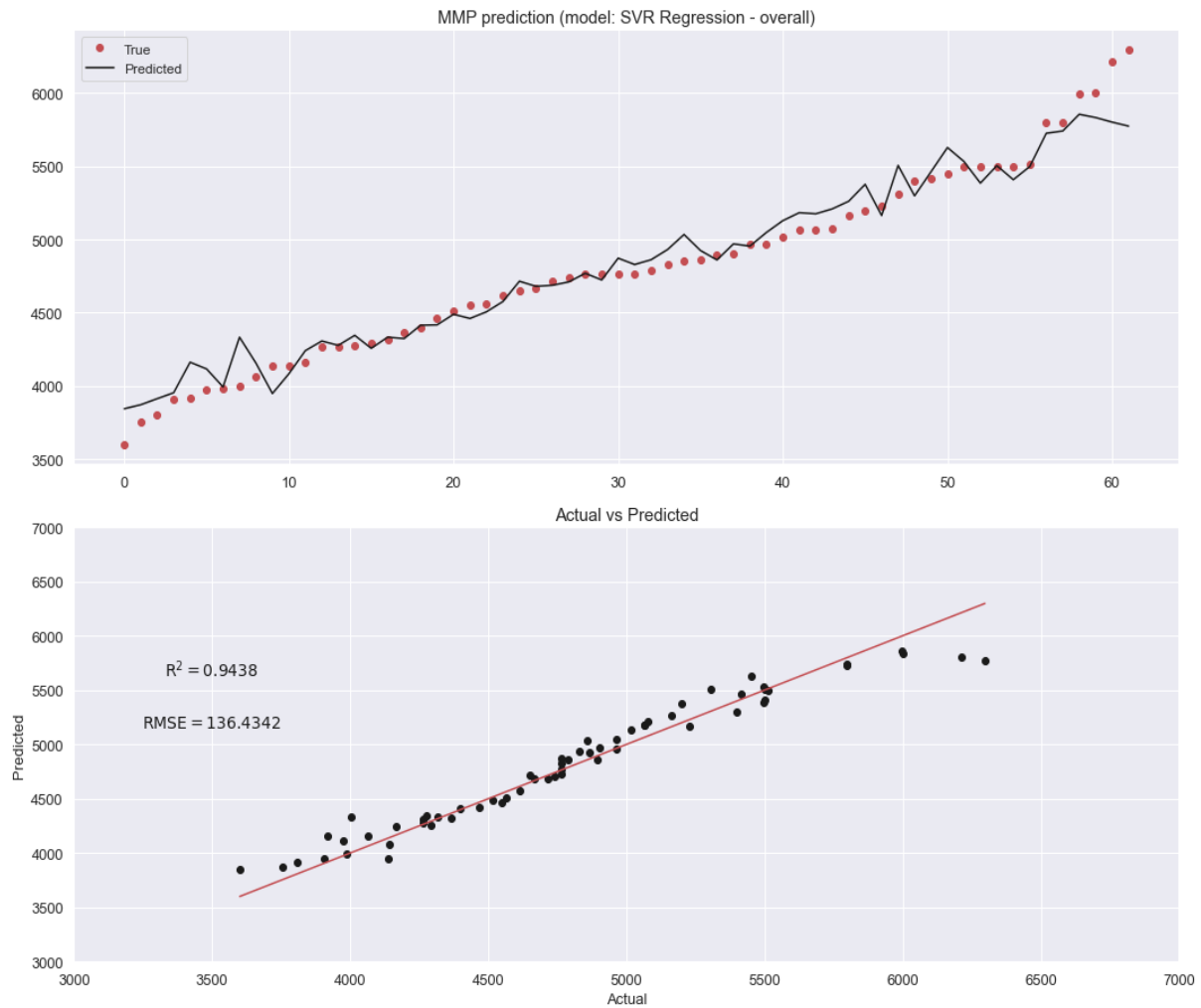

Figure 8.14 Overall SVR model performance for MMP prediction in methane-gas oil system

8.4.3. Model Performance Comparison

In this work, the tested machine learning algorithms (MLP and SVR) presented high capability of predicting MMP under a wide range of pressure and temperature conditions. Table 8.2 below summarizes the model accuracy based on the calculated performance metrics. As the results indicate, both MLP and SVR resulted in the same accuracy of MMP in the hydrocarbon gas-oil system. However, the regression plot indicated higher prediction accuracy in the middle range of the MMP scale, where the prediction accuracy tends to slightly decrease at the extreme sides of the plot which is probably due to having less data to train the model. For the methane-oil system, MLP neural network algorithm resulted in slightly higher prediction accuracy. In general, the presented machine learning models

demonstrate the promising potential of accurately predicting MMP under a wide range of input parameters using the innovative artificial intelligence solutions.

Table 8.2 Model performance comparison summary

Model	System	R ²	RMSE
MLP	Hydrocarbon gas-oil	95.80%	168.2
SVR	Hydrocarbon gas-oil	95.80%	154.2
MLP	Methane-oil	96.60%	107.4
SVR	Methane-oil	94.60%	136.4

8.5. Conclusion

This work presents genuine models to predict the minimum miscibility pressure in hydrocarbon gas-oil systems. In particular, to the best of author's knowledge, this is the first machine learning models to predict MMP in pure/impure methane-oil system. Furthermore, the presented models take an advantage of using the largest hydrocarbon MMP database in the literature to cover a wider range of pressure, temperature and oil compositions for better prediction accuracy.

In this chapter, two machine learning models were developed and tested to predict the MMP of the hydrocarbon gas-oil system and methane oil system. Firstly, a review of the existing correlations and machine learning models was presented to highlight the gap in the literature. Afterwards, multilayer perceptron (MLP) neural network and support vector regression (SVR) algorithms were tested to predict the MMP using the collected database. For hydrocarbon gas-oil system, the models were developed using the complete MMP dataset (153 points), where both algorithms (MLP and SVR) resulted in a prediction accuracy of 95.8%. For methane-oil system, the models were developed using only the MMP data that have a gas content of 80% or higher of methane in the gas compositions, reducing the

database to 61 MMP points. The results show a higher MMP prediction accuracy using MLP algorithm compared to SVR, as the prediction accuracy was 96.6% and 94.6% respectively. The results of this work highlight the potential of machine learning models to be a fast and accurate alternative to predict the MMP. The presented models can also be used to predict the potential MMP reduction for different gas compositions by changing the gas content in the input parameters and running the model. Moreover, the accuracy of the model will keep improving with adding more MMP points into the database as the ML algorithm will likely to learn the underlying correlation between the parameter faster for more efficient prediction.

Chapter 9 Conclusion and Recommendations

9.1. Conclusion

Miscible gas injection is the most commonly applied enhanced oil recovery (EOR) method for light and medium crude oil, and it is widely considered as one of the most practical and efficient EOR techniques due to its lower cost and higher recovery factor compared to other EOR methods. However, the application of miscible hydrocarbon gas injection is limited compared to CO₂ due to the high minimum miscibility pressure in the hydrocarbon gas-oil system. This research presents a novel study to investigate, for the first time, the potential of reducing the minimum miscibility pressure of the methane-oil system, which could consequently increase the application envelop of miscible methane/hydrocarbon gas-oil system to more candidate reservoirs. In order to achieve the outlined research objectives, a comprehensive literature review was conducted to summarize the existing work in MMP reduction in CO₂-oil system and to identify the knowledge gap regarding similar approaches in methane/natural gas-oil systems. Afterwards, the potential of chemical assisted MMP reduction in methane-oil system was experimentally investigated for the first time using interfacial tension (IFT) measurements, then further IFT experiments were performed using different chemical headgroups and hydrocarbon chains to test different combinations of synthesized chemicals and to assist in better understanding of the miscibility mechanisms. After gaining insights about the proposed mechanism for MMP reduction and identifying the most effective chemical additives, the feasibility of the MMP reduction technique was then quantified by measuring the impact of MMP reduction on the oil recovery factor at core scale under different injection scenarios. The achieved results of the core flooding experiments confirmed the potential additional oil recovery after decreasing MMP and achieving near miscible conditions. Furthermore, the ultimate oil recovery using chemical additives was

compared to the oil recovery after adding enriching CO₂ gas to the injected methane to evaluate different methods of MMP reduction.

Finally, data science techniques were employed to generate a machine learning model to accurately predict MMP in hydrocarbon gas-oil system based on the injected gas composition. Firstly, a comprehensive database of 153 MMP data points measured by slim-tube experiment were collected from the literature. Secondly, statistical and graphical exploratory data analysis were performed to identify the main controlling factors of the miscibility process. Then, machine learning models were developed and tested to predict the MMP in hydrocarbon gas-oil and methane-oil systems.

The main findings of this research are summarized below according to the sequence of the chapters:

Experimental Investigation of Methane-Oil Interfacial Tension

Given that the high MMP in the methane-oil system limits the application of miscible methane injection for EOR. Therefore, this part of the research aims to present a novel experimental investigation of the potential of chemical assisted MMP reduction in methane-oil systems for the first time. The main results and findings have been given below,

The presented IFT results (Chapter 4) demonstrated the potential of reducing MMP in methane-oil system using chemical additives at different temperatures (333 K and 373 K). The results also highlighted that increasing temperature improves performance of chemicals and trigger a higher percentage of MMP reduction. Furthermore, surfactant-based chemicals proved to be more effective in improving gas-oil miscibility compared to alcohol-based chemicals, where a promising MMP reduction of 9% was achieved by using SOLOTERRA ME-6 (surfactant-based chemical). The results of this work likely expands the application envelop of the miscible natural gas injection to more candidate reservoir and consequently results in higher recovery factor.

The second set of IFT experiments (Chapter 5) were performed to gain further understanding of the miscibility mechanism in the presence of chemical additives. The IFT results revealed that the presence of polar components in the chemical's functional head group significantly improves methane-oil miscibility. Furthermore, optimizing chemical's hydrocarbon chain length triggers a higher percentage of MMP reduction where the shorter hydrocarbon chains were more effective in more improving the miscibility between gas and oil phases. Plausible mechanism of chemical-gas-oil interaction was proposed based on the presented results and analysis. The presented results in this work provide guidelines to synthesis an effective chemical for chemical-assisted MMP reduction in methane-oil system.

Experimental investigation of MMP reduction effect on recovery factor at core scale

This part of the work aims to test the chemical assisted MMP reduction at core scale to examine the feasibility of the proposed technique. The designed coreflooding experiments proved for the first time the potential of MMP reduction to increase the ultimate oil recovery factor in the methane-oil system. The main results and findings of the coreflooding experiments have been given below,

Coreflooding results (Chapter 6) verified the potential of chemical-assisted MMP reduction to increase oil recovery factor. An incremental oil recovery of 11.7% was achieved after reducing MMP and reaching near miscible conditions using 1.5 wt.% of the tested surfactant-based chemical (SOLOTERRA ME-6). The presented coreflooding experiments also verified the potential of chemical-assisted MMP reduction to improve oil recovery in secondary and tertiary modes. In addition, the results highlighted that the early application of miscible gas injections (secondary recovery) results in higher recovery compared to tertiary stage.

Overall, this work proved that a moderate MMP reduction could increase the recovery by up to 11.7%. Furthermore, the presented results demonstrated that a small fraction of surfactant-

based chemical (1.5 wt.%) could be as effective as adding 20% CO₂ into the injected methane to enhance oil recovery factor, which could be a practical alternative to improve the miscibility in case of lack of CO₂ sources.

Data Analysis and Machine Learning to predict MMP

Given that to date there is no robust correlation to predict the MMP in hydrocarbon gas-oil system, this part of the research aims to utilize the powerful tools of data science to develop a reliable machine learning model that is capable of predicting MMP in hydrocarbon gas-oil systems using different input parameters. The main results and findings have been given below,

The main miscibility controlling factors were identified for methane-oil and hydrocarbon gas-oil systems based on statistical and graphical data analysis of the collected database. The presented data analysis revealed that the controlling factors are highly dependent on gas composition. Therefore, to achieve reliable and accurate prediction accuracy, two separate machine learning models were presented for methane-oil system and hydrocarbon gas-oil system.

The presented work utilized two algorithms (multi-layer perceptron (MLP) and support vector regression (SVR)) to develop and test two machine learning models for each system. For the hydrocarbon gas-oil system, both algorithms (MLP and SVR) resulted in a prediction accuracy of 95.8%. For methane-oil system, where methane content is 80% or higher, MLP algorithm resulted in higher MMP prediction accuracy compared to SVR, as the prediction accuracy was 96.6% and 94.6% respectively. The presented models take an advantage of using the largest hydrocarbon MMP database in the literature to cover a wider range of pressure, temperature and oil compositions for better prediction accuracy. Furthermore, to the best of author's knowledge, this is the first machine learning models in the literature to predict MMP in pure/impure methane-oil system.

The results of this work highlight the potential of machine learning models to provide fast and accurate alternative to predict the MMP compared to the lengthy and costly experimental methods. In addition, the presented models could be used to accurately predict the potential MMP reduction for different gas and crude oil compositions by changing the input parameters of the model.

9.2. Recommendations

This research has successfully managed to achieve a number of significant outcomes related to reducing MMP in hydrocarbon gas-oil system. The following points outline the recommended further in-depth research aspects that could complement this work and potentially improve the confidence in applying chemical-assisted MMP reduction technique at field scale.

- In this study, the minimum miscibility pressure reduction has been investigated experimentally using chemical additives. Another promising route would be to utilize molecular dynamic simulation to test the effect of different chemical additives and concentrations on the minimum miscibility pressure of the hydrocarbon gas-oil system, which could potentially optimize the chemical concentration and improve the feasibility of the process.
- In this study, the potential of surfactant-based chemicals to improve methane-oil miscibility has been tested and verified for the first time. However, further experimental investigation to test more chemical additives to potentially achieve more MMP reduction at lower concentration would further improve the feasibility of the method. Further, more coreflooding experiments under different conditions including different rock types (carbonate and sandstone) would be beneficial for further assessment of the process.
- In this research, the results of two machine learning algorithms for each have been presented for each system. Further investigation to test different machine learning

algorithms would be beneficial to increase the reliability and confidence of the prediction, especially due to current lack of research in this area.

- There are several immiscible hydrocarbon gas flooding projects around the world. This study demonstrated that the minimum miscibility pressure can be reduced using chemical additives in the injection gas. The effect of these additives on the gas-oil IFT and MMP for such fields may be worth investigating.

References

1. (1981), B.P.C., *BP statistical review of world energy*. 2020.
2. Gbadamosi, A.O., et al., *An overview of chemical enhanced oil recovery: recent advances and prospects*. International Nano Letters, 2019.
3. Kamal, M.S., et al., *Recent Advances in Nanoparticles Enhanced Oil Recovery: Rheology, Interfacial Tension, Oil Recovery, and Wettability Alteration*. Journal of Nanomaterials, 2017. **2017**: p. 1-15.
4. Alvarado, V. and E. Manrique, *Enhanced Oil Recovery: An Update Review*. Energies, 2010. **3**(9): p. 1529-1575.
5. Stalkup, F.I., Jr., *Status of Miscible Displacement*. Journal of Petroleum Technology, 1983. **35**(04): p. 815-826.
6. El-hoshoudy, A.N. and S. Desouky, *CO₂ Miscible Flooding for Enhanced Oil Recovery, in Carbon Capture, Utilization and Sequestration*. 2018.
7. Perera, M., et al., *A Review of CO₂-Enhanced Oil Recovery with a Simulated Sensitivity Analysis*. Energies, 2016. **9**(7).
8. Agista, M., K. Guo, and Z. Yu, *A State-of-the-Art Review of Nanoparticles Application in Petroleum with a Focus on Enhanced Oil Recovery*. Applied Sciences, 2018. **8**(6).
9. Jha, K., *A laboratory study of heavy oil recovery with carbon dioxide*. Journal of Canadian Petroleum Technology, 1986. **25**(02).
10. Hara, S. and P. Christman, *Investigation of a cyclic countercurrent light-oil/CO₂ immiscible process*. SPE Advanced Technology Series, 1993. **1**(01): p. 159-165.
11. Orr, J.F.M. and J.J. Taber, *Displacement of oil by carbon dioxide. Final report*. 1981: United States.
12. Agency, I.E., *World Energy Outlook 2018*. 2018.
13. Jin, L., et al., *Impact of CO₂ Impurity on MMP and Oil Recovery Performance of the Bell Creek Oil Field*. Energy Procedia, 2017. **114**: p. 6997-7008.
14. Al-Mjeni, R., et al., *Has the time come for EOR?* Oilfield Review, 2010. **22**: p. 16-35.
15. Godec, M., et al., *CO₂ storage in depleted oil fields: The worldwide potential for carbon dioxide enhanced oil recovery*. Energy Procedia, 2011. **4**: p. 2162-2169.
16. Jia, B., J.-S. Tsau, and R. Barati, *A review of the current progress of CO₂ injection EOR and carbon storage in shale oil reservoirs*. Fuel, 2019. **236**: p. 404-427.
17. Hawthorne, S.B., et al., *Effects of Reservoir Temperature and Percent Levels of Methane and Ethane on CO₂/Oil MMP Values as Determined using Vanishing Interfacial Tension/Capillary Rise*. Energy Procedia, 2017. **114**: p. 5287-5298.
18. Fathinasab, M., et al., *Minimum miscibility pressure and interfacial tension measurements for N₂ and CO₂ gases in contact with W/O emulsions for different temperatures and pressures*. Fuel, 2018. **225**: p. 623-631.
19. Nobakht, M., S. Moghadam, and Y. Gu, *Mutual interactions between crude oil and CO₂ under different pressures*. Fluid Phase Equilibria, 2008. **265**(1-2): p. 94-103.
20. Thomas, S., *Enhanced Oil Recovery - An Overview*. Oil & Gas Science and Technology - Revue de l'IFP, 2007. **63**(1): p. 9-19.
21. Teletzke, G.F., P.D. Patel, and A. Chen, *Methodology for Miscible Gas Injection EOR Screening*, in *SPE International Improved Oil Recovery Conference in Asia Pacific*. 2005, Society of Petroleum Engineers: Kuala Lumpur, Malaysia. p. 11.
22. Wang, X. and Y. Gu, *Oil Recovery and Permeability Reduction of a Tight Sandstone Reservoir in Immiscible and Miscible CO₂ Flooding Processes*. Industrial & Engineering Chemistry Research, 2011. **50**(4): p. 2388-2399.

23. Cao, M. and Y. Gu, *Physicochemical Characterization of Produced Oils and Gases in Immiscible and Miscible CO₂ Flooding Processes*. Energy & Fuels, 2013. **27**(1): p. 440-453.
24. Kulkarni, M.M. and D.N. Rao, *Experimental investigation of miscible and immiscible Water-Alternating-Gas (WAG) process performance*. Journal of Petroleum Science and Engineering, 2005. **48**(1): p. 1-20.
25. Cao, M. and Y. Gu, *Oil recovery mechanisms and asphaltene precipitation phenomenon in immiscible and miscible CO₂ flooding processes*. Fuel, 2013. **109**: p. 157-166.
26. Holm, L.W., & Josendal, V. A. , *Mechanisms of Oil Displacement By Carbon Dioxide*. Society of Petroleum Engineers., 1974.
27. Al-Wahaibi, Y.M., *First-Contact-Miscible and Multicontact-Miscible Gas Injection within a Channeling Heterogeneity System*. Energy & Fuels, 2010. **24**(3): p. 1813-1821.
28. Holm, L.W., & Josendal, V. A. , *Mechanisms of Oil Displacement By Carbon Dioxide*. Society of Petroleum Engineers Journal, 1974.
29. Al Hinai, N.M., et al., *Effects of oligomers dissolved in CO₂ or associated gas on IFT and miscibility pressure with a gas-light crude oil system*. Journal of Petroleum Science and Engineering, 2019. **181**.
30. Gu, Y., P. Hou, and W. Luo, *Effects of Four Important Factors on the Measured Minimum Miscibility Pressure and First-Contact Miscibility Pressure*. Journal of Chemical & Engineering Data, 2013. **58**(5): p. 1361-1370.
31. Yang, Z., et al., *Interfacial tension of CO₂ and crude oils under high pressure and temperature*. Colloids and Surfaces A: Physicochemical and Engineering Aspects, 2015. **482**: p. 611-616.
32. Yang, Z., et al., *Reducing the minimum miscibility pressure of CO₂ and crude oil using alcohols*. Colloids and Surfaces A: Physicochemical and Engineering Aspects, 2019. **568**: p. 105-112.
33. Safaei, A., Y. Kazemzadeh, and M. Riazi, *Mini Review of Miscible Condition Evaluation and Experimental Methods of Gas Miscible Injection in Conventional and Fractured Reservoirs*. Energy & Fuels, 2021.
34. Orr, F.M. and K. Jessen, *An analysis of the vanishing interfacial tension technique for determination of minimum miscibility pressure*. Fluid Phase Equilibria, 2007. **255**(2): p. 99-109.
35. Golkari, A. and M. Riazi, *Experimental investigation of miscibility conditions of dead and live asphaltenic crude oil–CO₂ systems*. Journal of Petroleum Exploration and Production Technology, 2016. **7**(2): p. 597-609.
36. Rommerskirchen, R., et al., *Reducing the Miscibility Pressure in Gas Injection Oil Recovery Processes*, in *Abu Dhabi International Petroleum Exhibition & Conference*. 2016, Society of Petroleum Engineers: Abu Dhabi, UAE. p. 14.
37. Li, S. and P. Luo, *Experimental and simulation determination of minimum miscibility pressure for a Bakken tight oil and different injection gases*. Petroleum, 2017. **3**(1): p. 79-86.
38. Yellig, W.F. and R.S. Metcalfe, *Determination and Prediction of CO₂ Minimum Miscibility Pressures (includes associated paper 8876)*. Journal of Petroleum Technology, 1980. **32**(01): p. 160-168.
39. Bon, J., H.K. Sarma, and A.M. Theophilos, *An Investigation of Minimum Miscibility Pressure for CO₂ - Rich Injection Gases with Pentanes-Plus Fraction*, in *SPE International Improved Oil Recovery Conference in Asia Pacific*. 2005, Society of Petroleum Engineers: Kuala Lumpur, Malaysia. p. 10.
40. Zhang, K., et al., *A review of experimental methods for determining the Oil–Gas minimum miscibility pressures*. Journal of Petroleum Science and Engineering, 2019. **183**.

41. Flock, D.L. and A. Nouar, *PARAMETRIC ANALYSIS ON THE DETERMINATION OF THE MINIMUM MISCIBILITY PRESSURE IN SLIM TUBE DISPLACEMENTS*. Journal of Canadian Petroleum Technology, 1984. **23**(5): p. 80-88.
42. Holm, L.W. and V.A. Josendal, *Effect of Oil Composition on Miscible-Type Displacement by Carbon Dioxide*. Society of Petroleum Engineers Journal, 1982. **22**(01): p. 87-98.
43. Zhang, K. and Y. Gu, *Two different technical criteria for determining the minimum miscibility pressures (MMPs) from the slim-tube and coreflood tests*. Fuel, 2015. **161**: p. 146-156.
44. Elsharkawy, A.M., F.H. Poettmann, and R.L. Christiansen, *Measuring Minimum Miscibility Pressure: Slim-Tube or Rising-Bubble Method?*, in *SPE/DOE Enhanced Oil Recovery Symposium*. 1992, Society of Petroleum Engineers: Tulsa, Oklahoma. p. 10.
45. Graue, D.J. and E.T. Zana, *Study of a Possible CO₂ Flood in Rangely Field*. Journal of Petroleum Technology, 1981. **33**(07): p. 1312-1318.
46. Ahmad, W., et al., *Experimental Determination of Minimum Miscibility Pressure*. Procedia Engineering, 2016. **148**: p. 1191-1198.
47. Zhang, H., D. Hou, and K. Li, *An Improved CO₂-Crude Oil Minimum Miscibility Pressure Correlation*. Journal of Chemistry, 2015. **2015**: p. 1-10.
48. Elsharkawy, A.M., F.H. Poettmann, and R.L. Christiansen, *Measuring CO₂ Minimum Miscibility Pressures: Slim-Tube or Rising-Bubble Method?* Energy & Fuels, 1996. **10**(2): p. 443-449.
49. Glaso, O., *Miscible Displacement: Recovery Tests With Nitrogen*. SPE Reservoir Engineering, 1990. **5**(01): p. 61-68.
50. Ekundayo, J.M. and S.G. Ghedan, *Minimum Miscibility Pressure Measurement with Slim Tube Apparatus - How Unique is the Value?*, in *SPE Reservoir Characterization and Simulation Conference and Exhibition*. 2013, Society of Petroleum Engineers: Abu Dhabi, UAE. p. 10.
51. Mihcakan, M., *Minimum Miscibility Pressure, Rising Bubble Apparatus, and Phase Behavior*, in *SPE/DOE Improved Oil Recovery Symposium*. 1994, Society of Petroleum Engineers: Tulsa, Oklahoma. p. 9.
52. Rao, D.N. and J.I. Lee, *Application of the new vanishing interfacial tension technique to evaluate miscibility conditions for the Terra Nova Offshore Project*. Journal of Petroleum Science and Engineering, 2002. **35**(3): p. 247-262.
53. Hawthorne, S.B., et al., *Rapid and Simple Capillary-Rise/Vanishing Interfacial Tension Method To Determine Crude Oil Minimum Miscibility Pressure: Pure and Mixed CO₂, Methane, and Ethane*. Energy & Fuels, 2016. **30**(8): p. 6365-6372.
54. Rao, D.N., *A new technique of vanishing interfacial tension for miscibility determination*. Fluid Phase Equilibria, 1997. **139**(1): p. 311-324.
55. Zhang, K. and Y. Gu, *Two new quantitative technical criteria for determining the minimum miscibility pressures (MMPs) from the vanishing interfacial tension (VIT) technique*. Fuel, 2016. **184**: p. 136-144.
56. Cheng, P., et al., *Automation of Axisymmetric Drop Shape-Analysis for Measurement of Interfacial-Tensions and Contact Angles*. Colloids and Surfaces, 1990. **43**: p. 151-167.
57. Sequeira, D.S., S.C. Ayirala, and D.N. Rao, *Reservoir Condition Measurements of Compositional Effects on Gas-Oil Interfacial Tension and Miscibility*, in *SPE Symposium on Improved Oil Recovery*. 2008, Society of Petroleum Engineers: Tulsa, Oklahoma, USA. p. 24.
58. Bayat, M., et al., *Investigation of gas injection flooding performance as enhanced oil recovery method*. Journal of Natural Gas Science and Engineering, 2016. **29**: p. 37-45.

59. Jessen, K. and F.M. Orr, *On Interfacial-Tension Measurements to Estimate Minimum Miscibility Pressures*. SPE Reservoir Evaluation & Engineering, 2008. **11**(05): p. 933-939.
60. Ghorbani, M., et al., *Modified vanishing interfacial tension (VIT) test for CO₂-oil minimum miscibility pressure (MMP) measurement*. Journal of Natural Gas Science and Engineering, 2014. **20**: p. 92-98.
61. Zhou, D. and F.M. Orr, Jr., *An Analysis of Rising Bubble Experiments to Determine Minimum Miscibility Pressures*. SPE Journal, 1998. **3**(01): p. 19-25.
62. Christiansen, R.L. and H.K. Haines, *Rapid Measurement of Minimum Miscibility Pressure With the Rising-Bubble Apparatus*. SPE Reservoir Engineering, 1987. **2**(04): p. 523-527.
63. Zhang, K. and Y. Gu, *New qualitative and quantitative technical criteria for determining the minimum miscibility pressures (MMPs) with the rising-bubble apparatus (RBA)*. Fuel, 2016. **175**: p. 172-181.
64. Zhang, K., N. Jia, and F. Zeng, *Application of predicted bubble-rising velocities for estimating the minimum miscibility pressures of the light crude oil-CO₂ systems with the rising bubble apparatus*. Fuel, 2018. **220**: p. 412-419.
65. Czarnota, R., et al., *Minimum miscibility pressure measurement for CO₂ and oil using rapid pressure increase method*. Journal of CO₂ Utilization, 2017. **21**: p. 156-161.
66. Zhou, D. and F.M. Orr, Jr., *An Analysis of Rising Bubble Experiments to Determine Minimum Miscibility Pressures*, in *SPE Annual Technical Conference and Exhibition*. 1995, Society of Petroleum Engineers: Dallas, Texas. p. 883-892.
67. Yang, Y., et al., *Improving oil recovery in the CO₂ flooding process by utilizing nonpolar chemical modifiers*. Chinese Journal of Chemical Engineering, 2016. **24**(5): p. 646-650.
68. Guo, P., et al., *Use of oil-soluble surfactant to reduce minimum miscibility pressure*. Petroleum Science and Technology, 2017. **35**(4): p. 345-350.
69. Liu, J., et al., *Experimental Study on Reducing CO₂-Oil Minimum Miscibility Pressure with Hydrocarbon Agents*. Energies, 2019. **12**(10).
70. Luo, H., et al., *Effects of the Non-ionic Surfactant (CiPOj) on the Interfacial Tension Behavior between CO₂ and Crude Oil*. Energy & Fuels, 2018. **32**(6): p. 6708-6712.
71. Li, Q., et al., *Solubility of solid solutes in supercritical carbon dioxide with and without cosolvents*. Fluid Phase Equilibria, 2003. **207**(1): p. 183-192.
72. Djabbarah, N.F., *Miscible oil recovery process using carbon dioxide and alcohol*. 1988.
73. Rudyk, S., S. Hussain, and P. Spirov, *Supercritical extraction of crude oil by methanol- and ethanol-modified carbon dioxide*. The Journal of Supercritical Fluids, 2013. **78**: p. 63-69.
74. Moradi, B., et al., *Effects of alcohols on interfacial tension between carbon dioxide and crude oil at elevated pressures and temperature*. Journal of Petroleum Science and Engineering, 2014. **121**: p. 103-109.
75. Varadaraj, R., et al., *Effect of hydrocarbon chain branching on interfacial properties of monodisperse ethoxylated alcohol surfactants*. Journal of Colloid and Interface Science, 1991. **147**(2): p. 387-395.
76. Rosen, M.J. and J.T. Kunjappu, *Surfactants and interfacial phenomena*. 2012: John Wiley & Sons.
77. C. L. Voon, M.A., *Reduction of MMP Using Oleophilic Chemicals*. International Journal of Chemical and Molecular Engineering, 2014. **8**: p. 350-353.
78. de Castro, M.D.L., M. Valcárcel, and M.T. Tena, *Physico — Chemical Properties of Supercritical Fluids*, in *Analytical Supercritical Fluid Extraction*, M.D.L. de Castro, M. Valcárcel, and M.T. Tena, Editors. 1994, Springer Berlin Heidelberg: Berlin, Heidelberg. p. 32-78.

79. Qayyimah M, A., M. Awang, and S. Yusup, *Fatty Acid Methyl Ester from Rubber Seed Oil as Additives in Reducing the Minimum Miscibility Pressure of CO₂ and Crude Oil*. Journal of Applied Sciences, 2016. **16**(11): p. 542-548.
80. Zhang, J., *Amphiphilic Molecules*, in *Encyclopedia of Membranes*, E. Drioli and L. Giorno, Editors. 2015, Springer Berlin Heidelberg: Berlin, Heidelberg. p. 1-4.
81. Negin, C., S. Ali, and Q. Xie, *Most common surfactants employed in chemical enhanced oil recovery*. Petroleum, 2017. **3**(2): p. 197-211.
82. Sheng, J.J., *Chapter 7 - Surfactant Flooding*, in *Modern Chemical Enhanced Oil Recovery*, J.J. Sheng, Editor. 2011, Gulf Professional Publishing: Boston. p. 239-335.
83. Jarraghan, K., et al., *Wettability alteration of carbonate rocks by surfactants: A mechanistic study*. Colloids and Surfaces A: Physicochemical and Engineering Aspects, 2012. **410**: p. 1-10.
84. Salehi, M., S.J. Johnson, and J.-T. Liang, *Enhanced Wettability Alteration by Surfactants with Multiple Hydrophilic Moieties*. Journal of Surfactants and Detergents, 2010. **13**(3): p. 243-246.
85. Esmaeilzadeh, P., A. Bahramian, and Z. Fakhroueian, *Adsorption of Anionic, Cationic and Nonionic Surfactants on Carbonate Rock in Presence of ZrO₂ Nanoparticles*. Physics Procedia, 2011. **22**: p. 63-67.
86. James, C. and J. Eastoe, *Ion specific effects with CO₂-philic surfactants*. Current Opinion in Colloid & Interface Science, 2013. **18**(1): p. 40-46.
87. Mohamed, A., et al., *Universal surfactant for water, oils, and CO₂*. Langmuir, 2010. **26**(17): p. 13861-6.
88. Sagisaka, M., et al., *Effective and efficient surfactant for CO₂ having only short fluorocarbon chains*. Langmuir, 2012. **28**(30): p. 10988-96.
89. Gold, S., et al., *Branched trichain sulfosuccinates as novel water in CO₂ dispersants*. Colloid and polymer science, 2006. **284**: p. 1333-1337.
90. Alston, R.B., G.P. Kokolis, and C.F. James, *CO₂ Minimum Miscibility Pressure: A Correlation for Impure CO₂ Streams and Live Oil Systems*. Society of Petroleum Engineers Journal, 1985. **25**(02): p. 268-274.
91. Zhang, P.Y.H., S.; Sayegh, S.; Zhou, X.L., *Effect of CO₂ Impurities on Gas-Injection EOR Processes*. Society of Petroleum Engineers., 2004.
92. Hawthorne, S.B., et al., *Experimental Determinations of Minimum Miscibility Pressures Using Hydrocarbon Gases and CO₂ for Crude Oils from the Bakken and Cut Bank Oil Reservoirs*. Energy & Fuels, 2020. **34**(5): p. 6148-6157.
93. Teklu, T.W., et al., *Low salinity water–Surfactant–CO₂ EOR*. Petroleum, 2017. **3**(3): p. 309-320.
94. Ghedan, S.G., *Global Laboratory Experience of CO₂-EOR Flooding*, in *SPE/EAGE Reservoir Characterization and Simulation Conference*. 2009, Society of Petroleum Engineers: Abu Dhabi, UAE. p. 15.
95. Yongmao, H., et al., *Laboratory Investigation of CO₂ Flooding*, in *Nigeria Annual International Conference and Exhibition*. 2004, Society of Petroleum Engineers: Abuja, Nigeria. p. 6.
96. Kulkarni, M.M. and D.N. Rao, *Experimental investigation of miscible and immiscible Water-Alternating-Gas (WAG) process performance*. Journal of Petroleum Science and Engineering, 2005. **48**(1-2): p. 1-20.
97. Zhang, N., M. Wei, and B. Bai, *Statistical and analytical review of worldwide CO₂ immiscible field applications*. Fuel, 2018. **220**: p. 89-100.

98. Al Adasani, A. and B. Bai, *Analysis of EOR projects and updated screening criteria*. Journal of Petroleum Science and Engineering, 2011. **79**(1-2): p. 10-24.
99. Taber, J.J., F.D. Martin, and R.S. Seright, *EOR Screening Criteria Revisited—Part 2: Applications and Impact of Oil Prices*. SPE Reservoir Engineering, 1997. **12**(03): p. 199-206.
100. Kirby, C.F. and M.A. McHugh, *Phase Behavior of Polymers in Supercritical Fluid Solvents*. Chemical Reviews, 1999. **99**(2): p. 565-602.
101. Orr, F.M., Jr. and M.K. Silva, *Effect of Oil Composition on Minimum Miscibility Pressure—Part 2: Correlation*. SPE Reservoir Engineering, 1987. **2**(04): p. 479-491.
102. Zhang, P.Y., et al., *Effect of CO₂ Impurities on Gas-Injection EOR Processes*, in *SPE/DOE Symposium on Improved Oil Recovery*. 2004, Society of Petroleum Engineers: Tulsa, Oklahoma. p. 11.
103. Ahmad, W., et al., *Uniqueness, repeatability analysis and comparative evaluation of experimentally determined MMPs*. Journal of Petroleum Science and Engineering, 2016. **147**: p. 218-227.
104. Awang, C.L.V.a.M., *Reduction of MMP Using Oleophilic Chemicals*. World Academy of Science, Engineering and Technology International Journal of Chemical and Molecular Engineering, 2014. **8**.
105. Rosestolato, J.C.S., et al., *Lipid nanostructures as surfactant carriers for enhanced oil recovery*. Fuel, 2019. **239**: p. 403-412.
106. Yeung, A., T. Dabros, and J. Masliyah, *Does Equilibrium Interfacial Tension Depend on Method of Measurement?* Journal of Colloid and Interface Science, 1998. **208**(1): p. 241-247.
107. Myers, M., et al., *The impact of partition coefficient data on the interpretation of chemical tracer behaviour in carbon geosequestration projects*. Chemical Geology, 2017. **465**: p. 52-63.
108. Rezk, M.G. and J. Foroozesh, *Phase behavior and fluid interactions of a CO₂-Light oil system at high pressures and temperatures*. Heliyon, 2019. **5**(7): p. e02057.
109. Ahmed, T., *PVT Properties of Crude Oils*, in *Equations of State and PVT Analysis*. 2016. p. 239-466.
110. Hemmati-Sarapardeh, A., et al., *Experimental Determination of Interfacial Tension and Miscibility of the CO₂-Crude Oil System; Temperature, Pressure, and Composition Effects*. Journal of Chemical & Engineering Data, 2013. **59**(1): p. 61-69.
111. Yang, Z., et al., *Dispersion Property of CO₂ in Oil. 1. Volume Expansion of CO₂+ Alkane at near Critical and Supercritical Condition of CO₂*. Journal of Chemical & Engineering Data, 2012. **57**(3): p. 882-889.
112. Zolghadr, A., M. Escrochi, and S. Ayatollahi, *Temperature and Composition Effect on CO₂ Miscibility by Interfacial Tension Measurement*. Journal of Chemical & Engineering Data, 2013. **58**(5): p. 1168-1175.
113. Li, Q., et al., *Solubility of solid solutes in supercritical carbon dioxide with and without cosolvents*. Fluid Phase Equilibria, 2003. **207**(1-2): p. 183-192.
114. Agency, I.E., *World Energy Outlook 2019*. 2019.
115. Almobarak, M., et al., *Chemical-assisted minimum miscibility pressure reduction between oil and methane*. Journal of Petroleum Science and Engineering, 2021. **196**: p. 108094.
116. *INHIBITING HYDROCARBON HYDRATE AGGLOMERATION*, in *World Intellectual Property Organization*. 2018.
117. Kazemzadeh, Y., et al., *How do metal oxide nanoparticles influence on interfacial tension of asphaltic oil-Supercritical CO₂ systems?* The Journal of Supercritical Fluids, 2018. **135**: p. 1-7.

118. Prado, G.H.C., Y. Rao, and A. de Klerk, *Nitrogen Removal from Oil: A Review*. Energy & Fuels, 2016. **31**(1): p. 14-36.
119. Li, W., et al., *Effects of Salinity and N-, S-, and O-Bearing Polar Components on Light Oil–Brine Interfacial Properties from Molecular Perspectives*. The Journal of Physical Chemistry C, 2019. **123**(38): p. 23520-23528.
120. Li, S., et al., *Diffusion Behavior of Supercritical CO₂ in Micro- to Nanoconfined Pores*. Industrial & Engineering Chemistry Research, 2019. **58**(47): p. 21772-21784.
121. Zhang, K., L. Liu, and G. Huang, *Nanoconfined Water Effect on CO*

2

Utilization and Geological Storage. Geophysical Research Letters, 2020. **47**(15).

122. Abedini, A. and F. Torabi, *Oil Recovery Performance of Immiscible and Miscible CO₂ Huff-and-Puff Processes*. Energy & Fuels, 2014. **28**(2): p. 774-784.
123. Terry, R., *Enhanced Oil Recovery*. 2003. p. 503-518.
124. Watts, R.J. and C.A. Komar, *Gas miscible displacement enhanced oil recovery: Technology status report*. 1989: United States.
125. Norouzi, H., et al., *Analysis of Secondary and Tertiary High-Pressure Gas Injection at Different Miscibility Conditions: Mechanistic Study*. SPE Reservoir Evaluation & Engineering, 2019. **22**(01): p. 150-160.
126. Zhang, C., et al., *A novel system for reducing CO₂-crude oil minimum miscibility pressure with CO₂-soluble surfactants*. Fuel, 2020. **281**.
127. Almobarak, M., et al., *A review of chemical-assisted minimum miscibility pressure reduction in CO₂ injection for enhanced oil recovery*. Petroleum, 2021.
128. Almobarak, M., et al., *Chemical-assisted minimum miscibility pressure reduction between oil and methane*. Journal of Petroleum Science and Engineering, 2021. **196**.
129. Saad, S.M.I. and A.W. Neumann, *Axisymmetric Drop Shape Analysis (ADSA): An Outline*. Advances in Colloid and Interface Science, 2016. **238**: p. 62-87.
130. Zhang, K. and N. Jia, *Confined fluid interfacial tension calculations and evaluations in nanopores*. Fuel, 2019. **237**: p. 1161-1176.
131. Sheng, J., *Enhanced Oil Recovery Field Case Studies*. 2013.
132. Almobarak, M., et al., *Effect of Functional Groups on Chemical-Assisted MMP Reduction of a Methane-Oil System*. Energy & Fuels, 2021. **35**(18): p. 14519-14526.
133. Sequeira, D., *Compositional Effects on Gas-Oil Interfacial Tension and Miscibility at Reservoir Conditions*. 2006.
134. Honarvar, B., et al., *Experimental Investigation of Interfacial Tension Measurement and Oil Recovery by Carbonated Water Injection: A Case Study Using Core Samples from an Iranian Carbonate Oil Reservoir*. Energy & Fuels, 2017. **31**(3): p. 2740-2748.
135. Fathinasab, M., S. Ayatollahi, and A. Hemmati-Sarapardeh, *A rigorous approach to predict nitrogen-crude oil minimum miscibility pressure of pure and nitrogen mixtures*. Fluid Phase Equilibria, 2015. **399**: p. 30-39.
136. Ding, M., et al., *Potential to enhance CO₂ flooding in low permeability reservoirs by alcohol and surfactant as co-solvents*. Journal of Petroleum Science and Engineering, 2019. **182**.
137. Akintunji, F., et al., *Contributors*, in *Enhanced Oil Recovery Field Case Studies*, J.J. Sheng, Editor. 2013, Gulf Professional Publishing: Boston. p. xxi.
138. Katende, A. and F. Sagala, *A critical review of low salinity water flooding: Mechanism, laboratory and field application*. Journal of Molecular Liquids, 2019. **278**: p. 627-649.
139. Bartels, W.B., et al., *Literature review of low salinity waterflooding from a length and time scale perspective*. Fuel, 2019. **236**: p. 338-353.

140. Shaker Shiran, B. and A. Skauge, *Enhanced Oil Recovery (EOR) by Combined Low Salinity Water/Polymer Flooding*. Energy & Fuels, 2013. **27**(3): p. 1223-1235.
141. Feng, H., et al., *Assessment of miscibility effect for CO₂ flooding EOR in a low permeability reservoir*. Journal of Petroleum Science and Engineering, 2016. **145**: p. 328-335.
142. Hawthorne, S.B. and D.J. Miller, *A comparison of crude oil hydrocarbon mobilization by vaporization gas drive into methane, ethane, and carbon dioxide at 15.6 MPa and 42 °C*. Fuel, 2019. **249**: p. 392-399.
143. Fathinasab, M. and K. Shahbazi, *A new correlation for estimation of minimum miscibility pressure (MMP) during hydrocarbon gas injection*. Journal of Petroleum Exploration and Production Technology, 2020. **10**(6): p. 2349-2356.
144. Edalat, M., et al. *Development of a New Artificial Neural Network Model for predicting Minimum Miscibility Pressure in Hydrocarbon Gas Injection*. in *SPE Middle East Oil and Gas Show and Conference*. 2007.
145. Mogensen, K. *An Accurate Model for Prediction of Hydrocarbon Gas MMP Based on a Large High-Temperature Data Set*. in *Abu Dhabi International Petroleum Exhibition & Conference*. 2020.
146. Benham, A.L., W.E. Dowden, and W.J. Kunzman, *Miscible Fluid Displacement - Prediction of Miscibility*. Transactions of the AIME, 1960. **219**(01): p. 229-237.
147. Glaso, *Generalized Minimum Miscibility Pressure Correlation*. SPE Advanced Technology Series, 1985(SPE-12893).
148. Kuo, S.S. *Prediction of Miscibility for the Enriched-Gas Drive Process*. in *SPE Annual Technical Conference and Exhibition*. 1985.
149. Firoozabadi, A. and A. Khalid, *Analysis and Correlation of Nitrogen and Lean-Gas Miscibility Pressure (includes associated paper 16463)*. SPE Reservoir Engineering, 1986. **1**(06): p. 575-582.
150. Eakin, B.E. and F.J. Mitch. *Measurement and Correlation of Miscibility Pressures of Reservoir Oils*. in *SPE Annual Technical Conference and Exhibition*. 1988.
151. Yurkiw, F.J. and D.L. Flock, *A Comparative Investigation of Minimum Miscibility Pressure Correlations For Enhanced Oil Recovery*. Journal of Canadian Petroleum Technology, 1994. **33**(08).
152. Jaubert, J.-N., L. Avaullee, and J.-F. Souvay, *A crude oil data bank containing more than 5000 PVT and gas injection data*. Journal of Petroleum Science and Engineering, 2002. **34**(1): p. 65-107.
153. Maklavani, A.M.V., A.; Moradi, B.; Tangsirifard, J., *New minimum miscibility pressure (MMP) correlation for hydrocarbon miscible injections*. Barazilian Journal of petroleum and gas, 2010. **4**(1): p. 011-018.
154. McGuire, P.L., et al. *Ethane-Based EOR: An Innovative and Profitable EOR Opportunity for a Low Price Environment*. in *SPE Improved Oil Recovery Conference*. 2016.
155. He, C., et al., *A new empirical correlation of minimum miscibility pressure for produced gas reinjection*. Energy Exploration & Exploitation, 2020. **38**(4): p. 867-883.
156. Sebastian, H.M., R.S. Wenger, and T.A. Renner, *Correlation of Minimum Miscibility Pressure for Impure CO₂ Streams*. Journal of Petroleum Technology, 1985. **37**(11): p. 2076-2082.
157. Al-Ajmi, M.F., et al. *EoS Modeling for Two Major Kuwaiti Oil Reservoirs*. in *SPE Middle East Oil and Gas Show and Conference*. 2011.
158. Deffrenne, P., C. Marle, and J. Pacsirszki. *The Determination Of Pressures Of Miscibility*. in *Fall Meeting of the Society of Petroleum Engineers of AIME*. 1961.

159. Firoozabadi, A. and K. Aziz, *Analysis and Correlation of Nitrogen and Lean-Gas Miscibility Pressure*. SPE Reservoir Engineering, 1986. 1(06): p. 575-582.
160. Williams, C.A., E.N. Zana, and G.E. Humphrys. *Use Of The Peng-Robinson Equation Of State To Predict Hydrocarbon Phase Behavior And Miscibility For Fluid Displacement*. in *SPE/DOE Enhanced Oil Recovery Symposium*. 1980.
161. Molina-Solana, M., et al., *Data science for building energy management: A review*. Renewable and Sustainable Energy Reviews, 2017. **70**: p. 598-609.
162. Huang, J., et al., *Intelligently Predict the Rock Joint Shear Strength Using the Support Vector Regression and Firefly Algorithm*. Lithosphere, 2021. **2021**(Special 4).
163. El-Banbi, A., A. Alzahabi, and A. El-Maraghi, *Chapter 3 - Dry Gases*, in *PVT Property Correlations*, A. El-Banbi, A. Alzahabi, and A. El-Maraghi, Editors. 2018, Gulf Professional Publishing. p. 29-63.
164. Ahmed, T., *Characterizing Hydrocarbon-Plus Fractions*, in *Equations of State and PVT Analysis*. 2016. p. 71-188.
165. Sircar, A., et al., *Application of machine learning and artificial intelligence in oil and gas industry*. Petroleum Research, 2021.
166. Karkevandi-Talkhooncheh, A., et al., *Modeling minimum miscibility pressure during pure and impure CO₂ flooding using hybrid of radial basis function neural network and evolutionary techniques*. Fuel, 2018. **220**: p. 270-282.
167. Barati-Harooni, A., et al., *Estimation of minimum miscibility pressure (MMP) in enhanced oil recovery (EOR) process by N₂ flooding using different computational schemes*. Fuel, 2019. **235**: p. 1455-1474.
168. Khan, M.R., et al. *Comparative Analysis of Intelligent Algorithms to Predict the Minimum Miscibility Pressure for Hydrocarbon Gas Flooding*. in *Abu Dhabi International Petroleum Exhibition & Conference*. 2019.
169. Shokrollahi, A., et al., *Intelligent model for prediction of CO₂ – Reservoir oil minimum miscibility pressure*. Fuel, 2013. **112**: p. 375-384.
170. Choubineh, A., A. Helalizadeh, and D.A. Wood, *Estimation of minimum miscibility pressure of varied gas compositions and reservoir crude oil over a wide range of conditions using an artificial neural network model*. Advances in Geo-Energy Research, 2019. **3**(1): p. 52-66.
171. Holmgren, G., et al., *Artificial neural networks improve and simplify intensive care mortality prognostication: a national cohort study of 217,289 first-time intensive care unit admissions*. J Intensive Care, 2019. **7**: p. 44.
172. Zhong, H., et al., *Vector field-based support vector regression for building energy consumption prediction*. Applied Energy, 2019. **242**: p. 403-414.
173. Jain, R.K., et al., *Forecasting energy consumption of multi-family residential buildings using support vector regression: Investigating the impact of temporal and spatial monitoring granularity on performance accuracy*. Applied Energy, 2014. **123**: p. 168-178.
174. Kavaklioglu, K., *Modeling and prediction of Turkey's electricity consumption using Support Vector Regression*. Applied Energy, 2011. **88**(1): p. 368-375.
175. Liang, R., et al., *Machine learning of weld joint penetration from weld pool surface using support vector regression*. Journal of Manufacturing Processes, 2019. **41**: p. 23-28.
176. Pedregosa, F., et al., *Scikit-learn: Machine learning in Python*. the Journal of machine Learning research, 2011. **12**: p. 2825-2830.

Every reasonable effort has been made to acknowledge the owners of copyright material. I would be pleased to hear from any copyright owner who has been omitted or incorrectly acknowledged.